

BUT

CHARLIE MEUBLE 5 ÉTAGÈRES

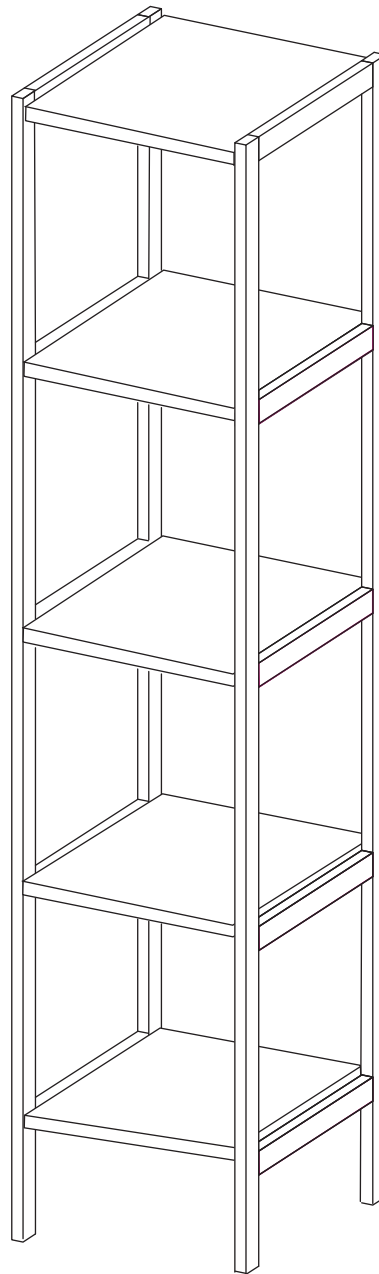

REFERENCE(S)

2099901541468



FR

Pensez à
donner ou recycler.



Association

ou



Magasin

ou



Déchèterie

<https://quefairedemesdechets.fr>



LE TRI
+ FACILE



Séparez les éléments avant de trier

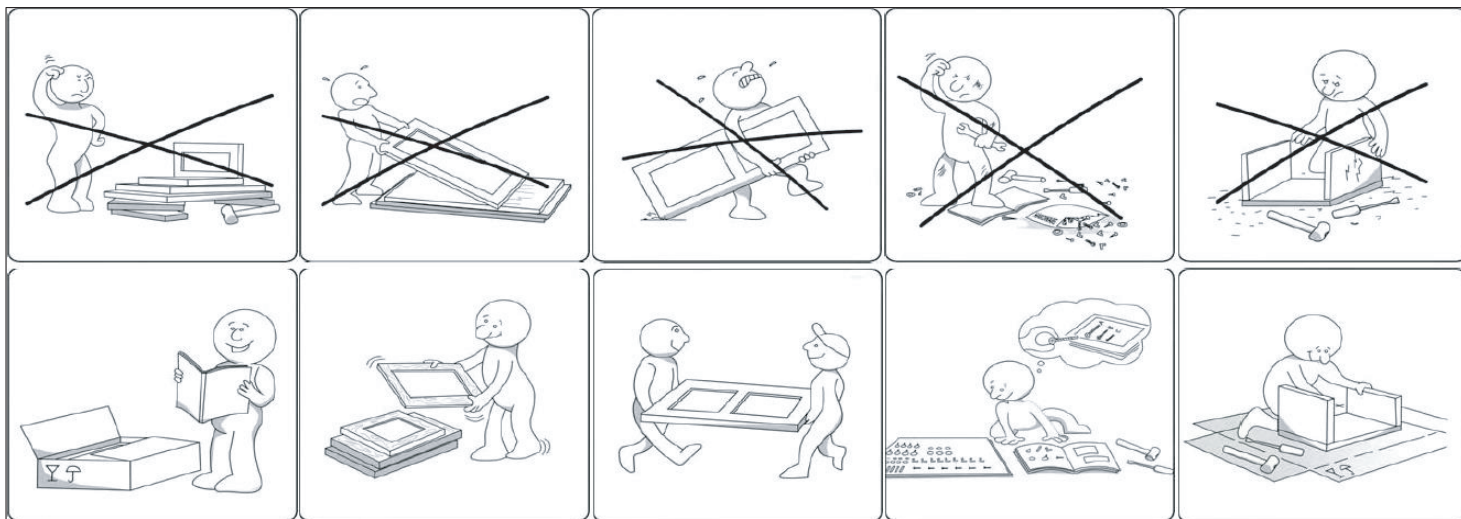

FR

CONSIGNES DE SECURITE

**IMPORTANT ! À LIRE ATTENTIVEMENT ET À CONSERVER
EN VUE D'UNE CONSULTATION ULTÉRIEURE**

Ce meuble est à usage domestique.

A monter soi-même.

Vérifier la présence et l'état de la quincaillerie et des pièces avant de débiter le montage.

Ne pas monter ou utiliser le mobilier si certains éléments sont cassés, endommagés ou manquants, et n'utiliser que des pièces approuvées par le fabricant.

Utiliser uniquement l'outillage fourni ou préconisé.

Serrer correctement les éléments de fixation avec l'outillage fourni ou préconisé.

Un mauvais montage, calage ou manutention peut entraîner une fragilisation des assemblages et/ou des pièces.

Tenir éloigné les jeunes enfants lors de l'assemblage. Présence de petites pièces susceptibles d'être ingérées.

Il convient que tous les dispositifs d'assemblage soient toujours convenablement serrés et régulièrement vérifiés, et resserrés, si nécessaire.

Ne pas déplacer un mobilier chargé.

IMPORTANT : Pour éviter le basculement accidentel du meuble, la fixation du meuble au mur est obligatoire.

La visserie nécessaire pour la jonction mur/meuble, dépendante de la nature du mur, n'est pas fournie. Adapter la quincaillerie à votre support. En cas de doute, consulter un spécialiste.

Les meubles contenant des panneaux à base de bois peuvent émettre des substances polluantes dans l'air intérieur. Il est donc recommandé, après l'installation du meuble, d'aérer fréquemment la pièce pendant au moins quatre semaines.

EN

SAFETY INFORMATION

**IMPORTANT ! READ CAREFULLY
AND KEEP FOR FUTURE REFERENCE**

This furniture is for domestic use.

Self-assembly required.

Check that all of the hardware and parts are present and in good condition before starting assembly.

Do not assemble or use the furniture if any of the parts are broken, damaged or missing, and only use parts approved by the manufacturer.

Only use tools that are supplied or recommended.

Firmly tighten the fasteners using the supplied or recommended tools.

Improper assembly, cribbing or handling can lead to assemblies and/or parts becoming weakened.

Keep young children away during assembly. The product contains small parts that could be ingested.

All joints should always be properly tightened and regularly checked, and retightened, if necessary.

Do not move furniture that is loaded.

IMPORTANT: To prevent the furniture accidentally tipping over, it must be affixed to the wall.

The screws required for the wall/furniture junction, which depend on the type of wall, are not supplied. Ensure that the hardware is suited to your substrate. If in doubt, consult a specialist.

Furniture containing wood-based panels (particleboard, fibreboard, plywood, etc.) can emit pollutants into the indoor air. You are therefore advised, after the furniture has been installed in its location, to ventilate the room frequently for at least four weeks in order to reduce exposure to the pollutants emitted by the furniture.

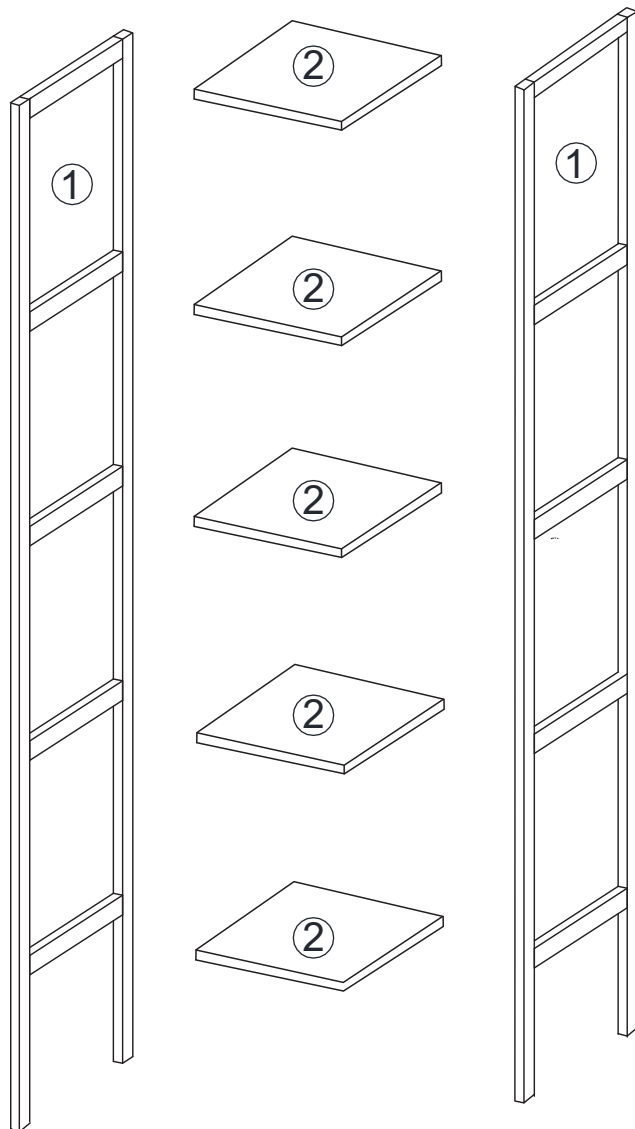

NON FOURNI(S)
NOT INCLUDED





1

No. Nr.	TAILLE/ABMESSUNGEN DIMENSION	Qté/Qtà Menge	CTN KTN
①	1300x300x13mm	x2	1/1
②	325x298x12mm	x5	1/1

Quincaillerie de montage / Hardware



A	X 20
	
Φ5 x 38mm	

B	X 1
	

C	X 2
	

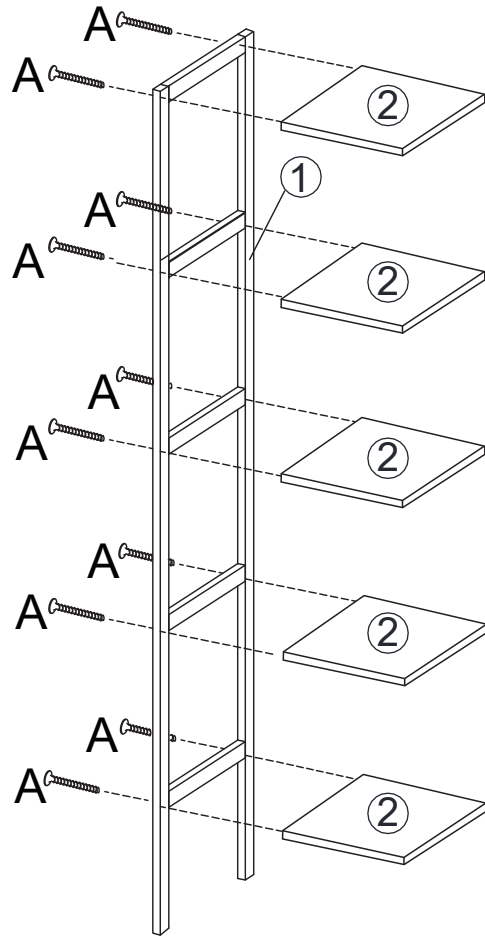

1



A		10pcs
B		1pc

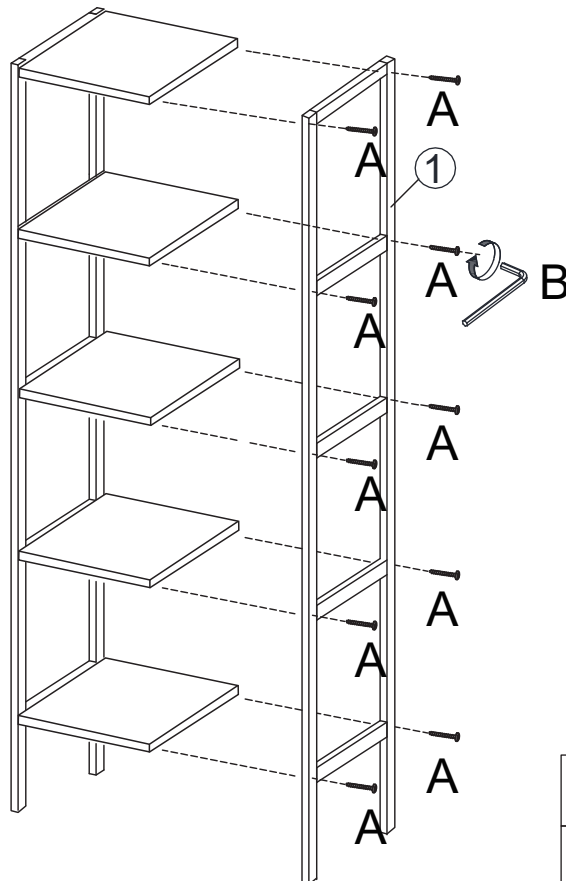

2



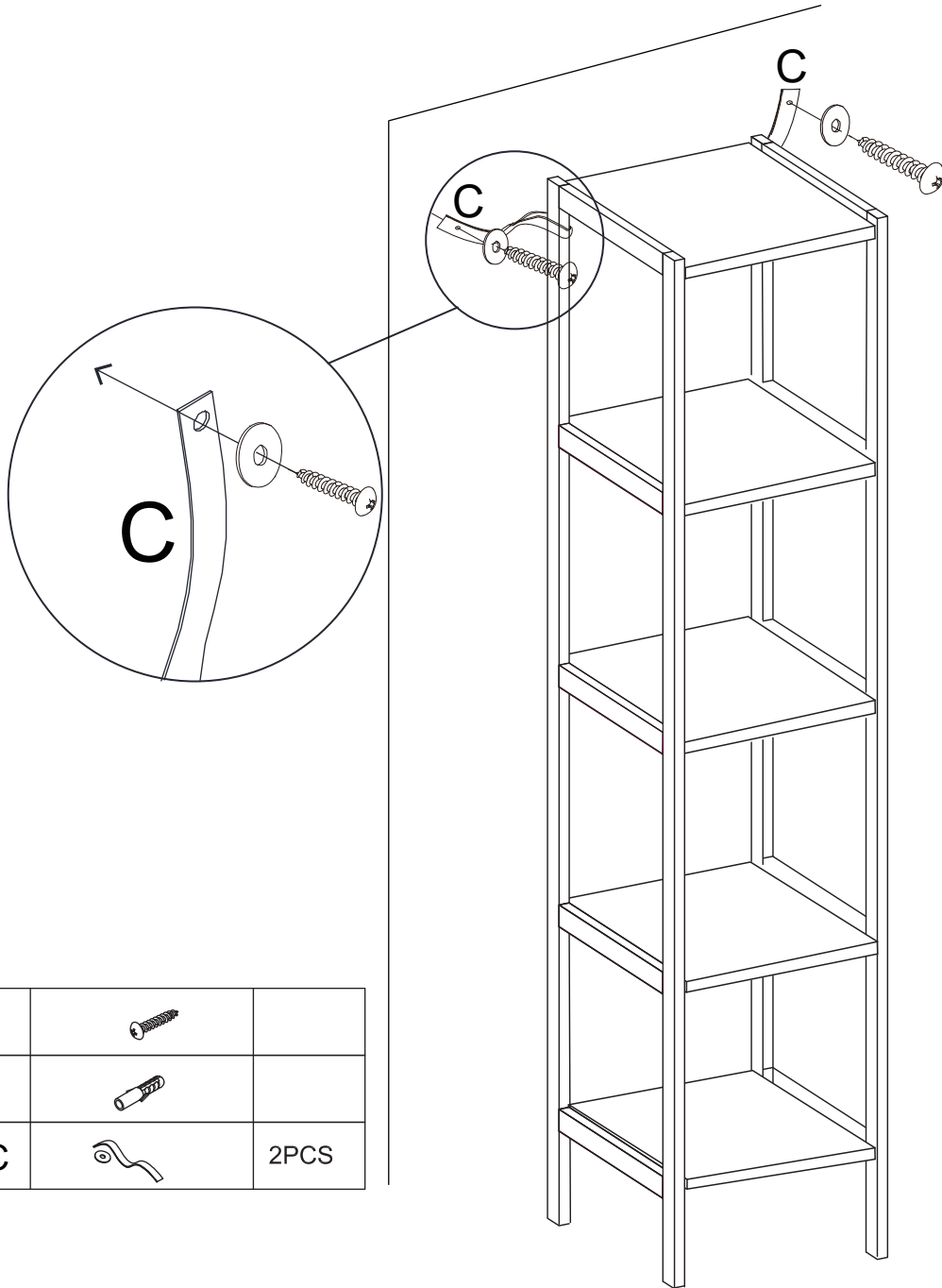

A		10pcs
B		1pc

3

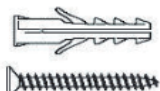
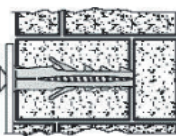
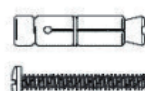
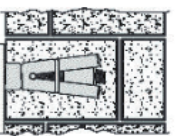
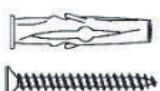
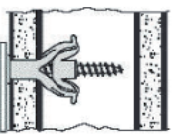

		
		
C		2PCS

⚠ Il existe une grande diversité de types de murs ou cloisons, c'est la raison pour laquelle nous ne pouvons vous fournir le type exact de fixation. Il est nécessaire d'identifier le type de paroi à laquelle vous allez fixer ce produit afin de vous procurer les fixations appropriées. Voici quelques exemples de fixations conseillées pour : ⚠

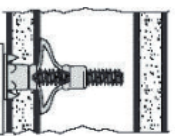
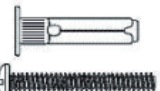
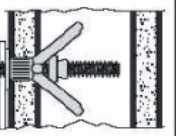
LES MURS PLEINS		LES CLOISONS CREUSES		
<p>CHEVILLE NYLON "FISCHER"</p>  	<p>CHEVILLE D'ANCRAGE MÉTAL</p>  	<p>CHEVILLE D'ANCRAGE A AILETTES EN NYLON</p>  	<p>CHEVILLE MÉTALLIQUE A EXPANSION</p>  	<p>CHEVILLE "MOLLY"</p>  



Utiliser une taille de forêt adaptée à la quincaillerie utilisée et au type de mur.

4

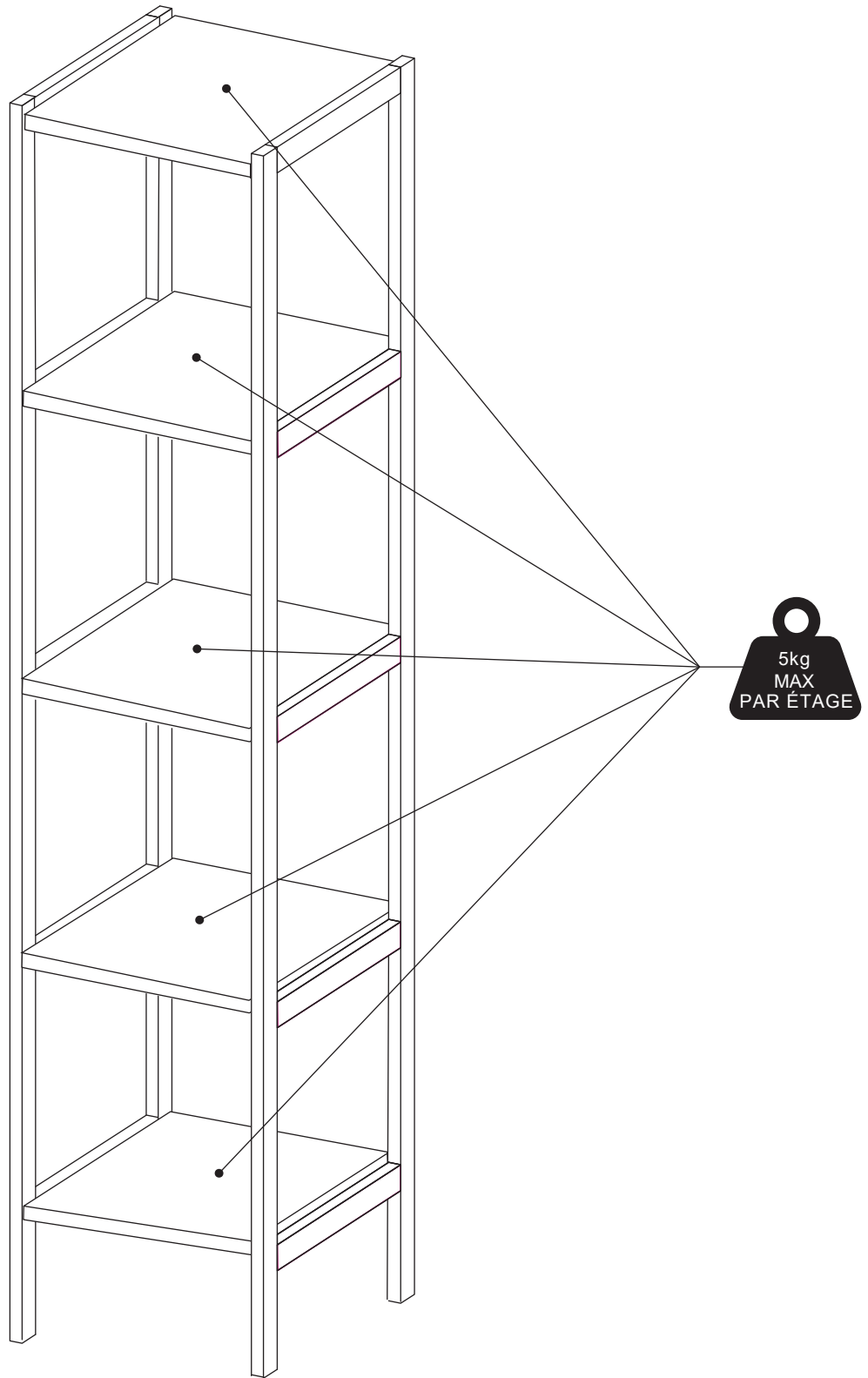

FR

CONSIGNES D' UTILISATION	<p>Ne jamais forcer les assemblages. Resserrez les vis après quelques temps d'usage.</p> <p>Gardez votre notice de montage, si une pièce venait à manquer, elle serait le plus clair moyen de communiquer avec votre magasin.</p> <p>Installer le produit sur une surface plane. S'assurer de la stabilité du produit avant utilisation.</p> <p>Respecter la charge maximale pour une utilisation sécurisée.</p> <p>Ne pas déplacer un mobilier chargé.</p>
RANGEMENT ET ENTRETIEN	<p>Dépoussiérer soigneusement puis humecter un chiffon doux et propre d'eau légèrement savonneuse.</p> <p>Ne pas utiliser de produits de nettoyage abrasifs ou solvants.</p>

EN

INSTRUCTIONS FOR USE	<p>Never force the connections. Re-tighten the screws after few days.</p> <p>Keep the Instructions AI leaflet, it contains information when claiming for missing parts.</p> <p>Install the product on a flat surface. Ensure product stability before use.</p> <p>Ensure to not exceed the maximum loading weight for a safe usage.</p> <p>Do not move loaded furniture.</p>
STORAGE AND CLEANING	<p>Carefully remove the dust. Use a soft and clean damp cloth with soapy water.</p> <p>Do not use abrasive cleaning products or solvents.</p>