



44 Avenue Paul Girard
10500 DIENVILLE
FRANCE
www.sciae.com

TERRA

INDICE A - 29/01/2026

TERRA 1129 Rangement vitrine 2pg N°20 Réf: 25SG3720

EAN: 3102000115245

NOTICE DE MONTAGE
ASSEMBLING INSTRUCTIONS
MONTAGEANLEIUNG
MANUAL DE MONTAJE
MONTAGEVOORSCHRIFT
INSTRUÇÕES DE MONTAGEM
ISTRUZIONI DI MONTAGGIO
ИНСТРУКЦИЯ ПО СБОРКЕ
Naputci za montažu



À monter
soi-même

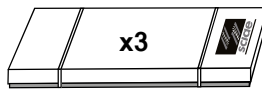

Package 1: 35 Kg
Package 2: 31.5 Kg
Package 3: 27 Kg

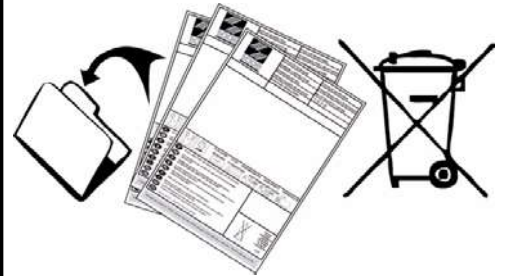

- F** POUR L'APRES-VENTE, RETOURNEZ AU MAGASIN AVEC CETTE NOTICE
- GB** FOR THE AFTER SALES, GO BACK TO THE SHOP WITH THIS ASSEMBLY INSTRUCTION
- D** WENDEN SIE SICH BITTE AN IHREN HANDLER UND GEBEN SIE IHM DIE KENNUMMER DES MOBELS UND DIE TEILNUMMER
- E** EN CASO DE SERVICIO POST-VENTA DEBEN DE VOLVER A LA TIENDA CON LAS INSTRUCCIONES DE MONTAJE
- NL** VOOR SERVICE NA VERKOOP, GA NAAR UW LEVERANCIER MET DEZE MONTAGE HANDLEIDING
- P** PARA O POS VENDA, VOLTE A LOJA COM ESTA FOLHA
- I** SERVIZIO POST VENDITA: E NECESSARIO PRESENTARSI SUL PUNTO VENDITA CON QUESTE ISTRUZIONI DI MONTAGGIO
- RU** ДЛЯ ПОСЛЕПРОДАЖНОГО ОБСЛУЖИВАНИЯ ПРОСЬБА ОБРАТИТЬСЯ В МАГАЗИН ПРЕДЪЯВИВ НАСТОЯЩУЮ ИНСТРУКЦИЮ ПО СБОРКЕ
- HR** U SLUČAJU REKLAMACIJE, VRATITE SE NA PRODAJNO MJESTO S OVIM UPUTAMA ZA MONTAŽU

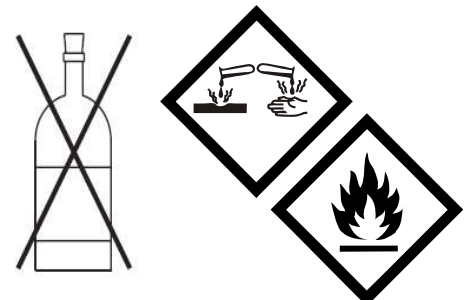
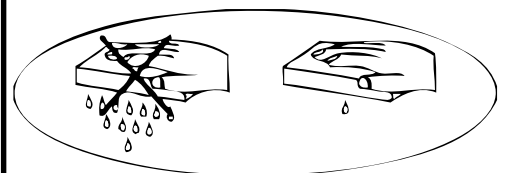





 +40°C
 +104°F

 +15°C
 +59°F



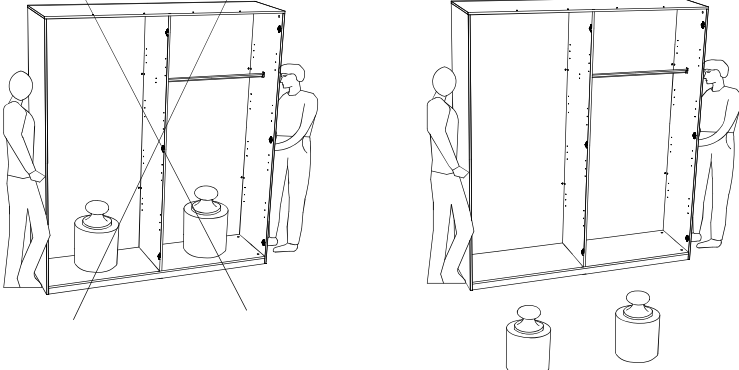

 HYGROMETRIE
 HYGROMETRY
 40%-65%



1 an
 1 year

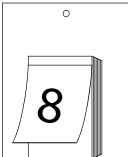

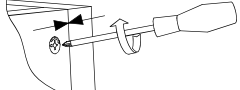

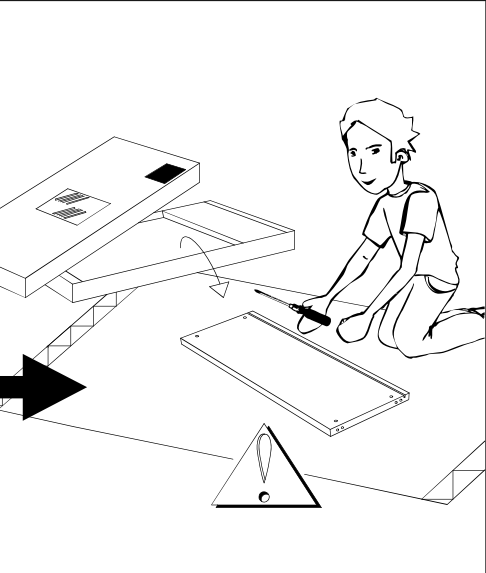
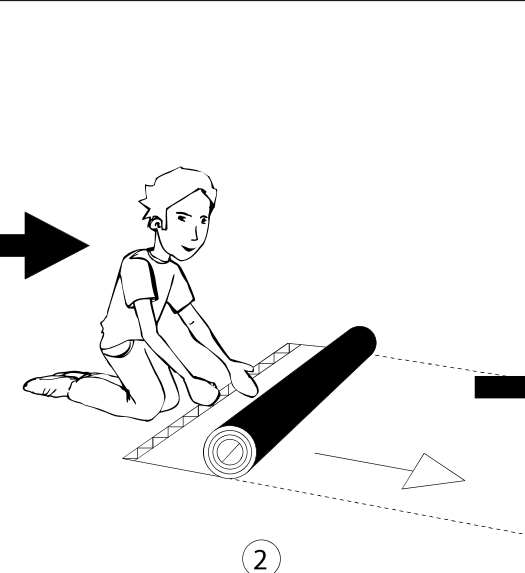
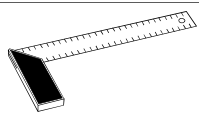
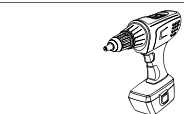
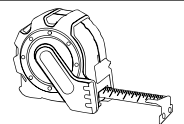
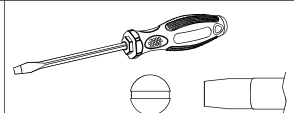
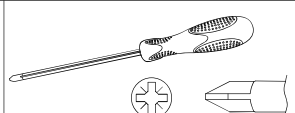
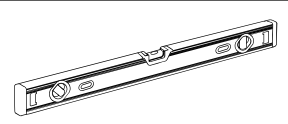
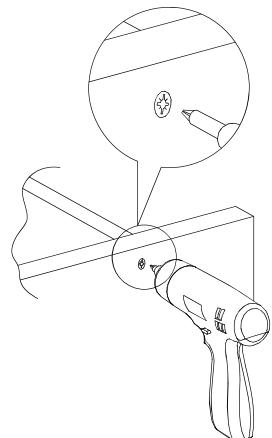
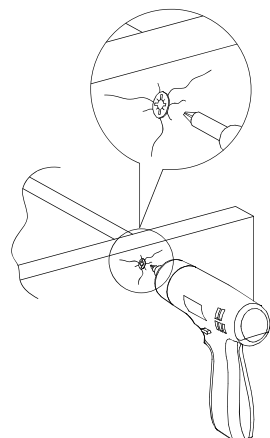
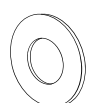
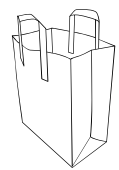
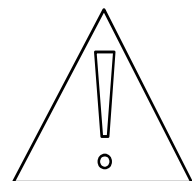
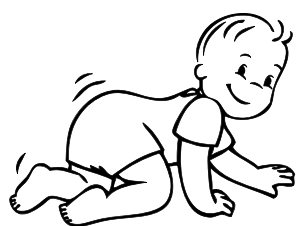

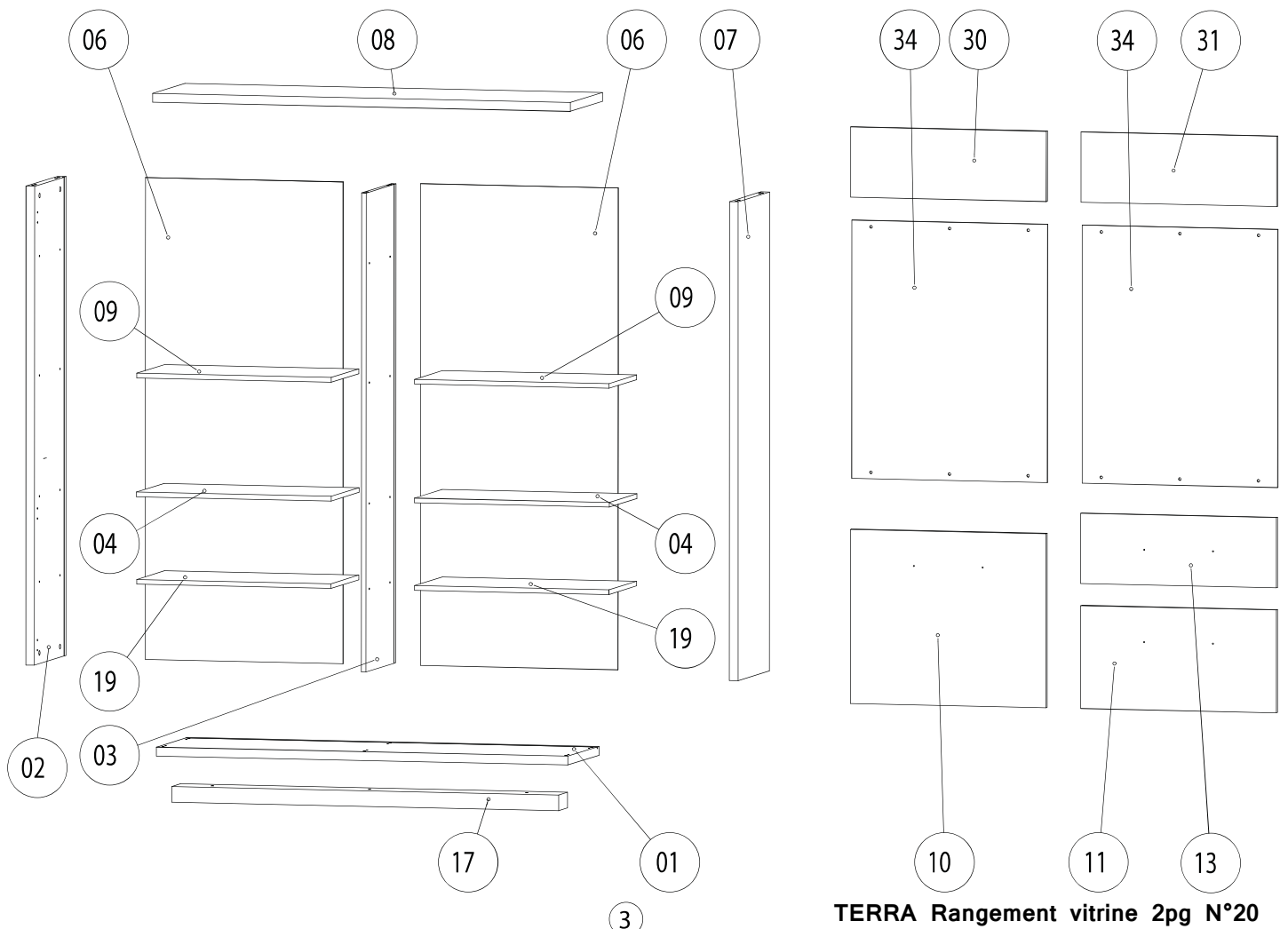

DESIGNATION	LONGUEUR	LARGEUR	EP.	N° PIECE	QTE	COLIS
Dessous	1340	390	28	01	1	1
Côté gauche	1514	390	28	02	1	2
Séparation	1514	365	15	03	1	2
Intermédiaire	634,5	339	15	04	2	1
Derrière	1523	643,5	2,5	06	2	3
Côté droit	1514	390	28	07	1	2
Dessus	1360	400	28	08	1	1
Tablette béton	633	339	15	09	2	1
Porte gauche	550	637	15	10	1	3
Porte droite	637	325	15	11	1	3
Fausse face de tiroir	637	222	15	13	1	3
Face de socle	1260	110	50	17	1	2
Tablette bois	633	339	15	19	2	1
Panneau haut porte gauche	222	637	15	30	1	3
Panneau haut porte droite	222	637	15	31	1	3
Glace de porte	816	637	5	34	2	3

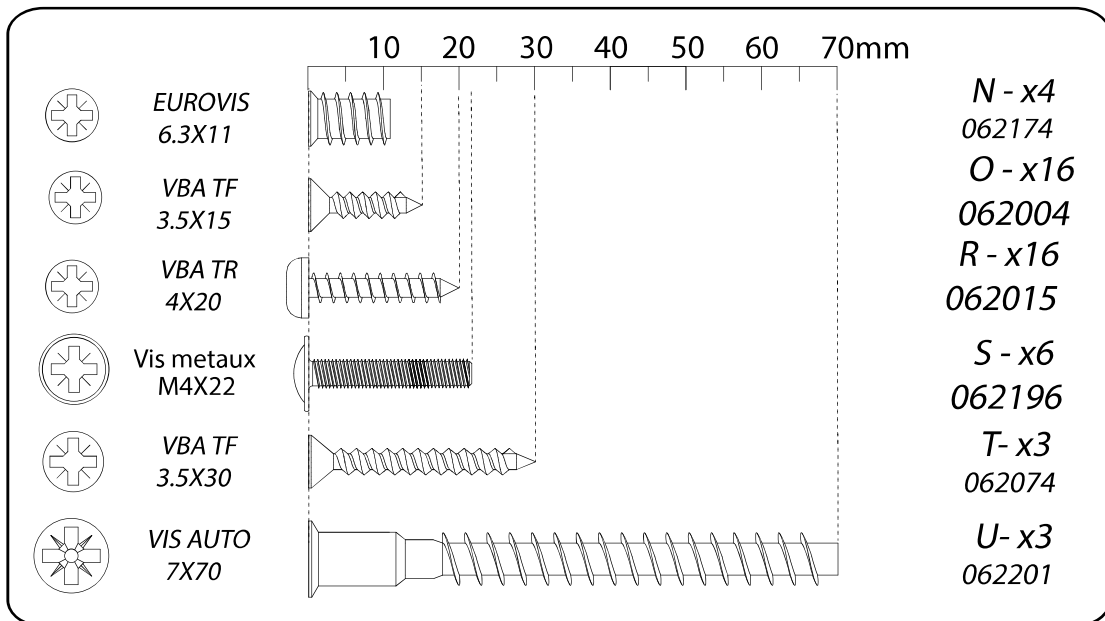
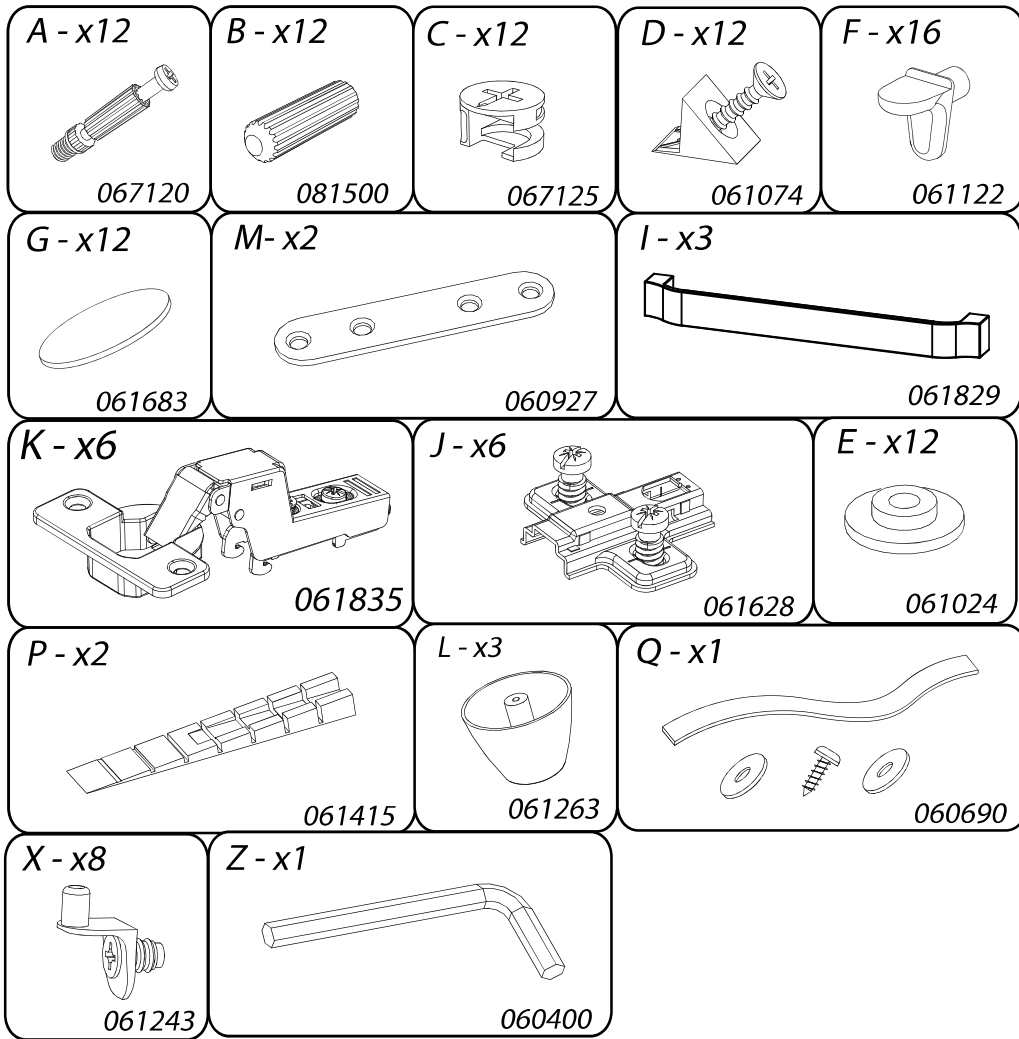

TERRA Rangement vitrine 2pg N°20



1

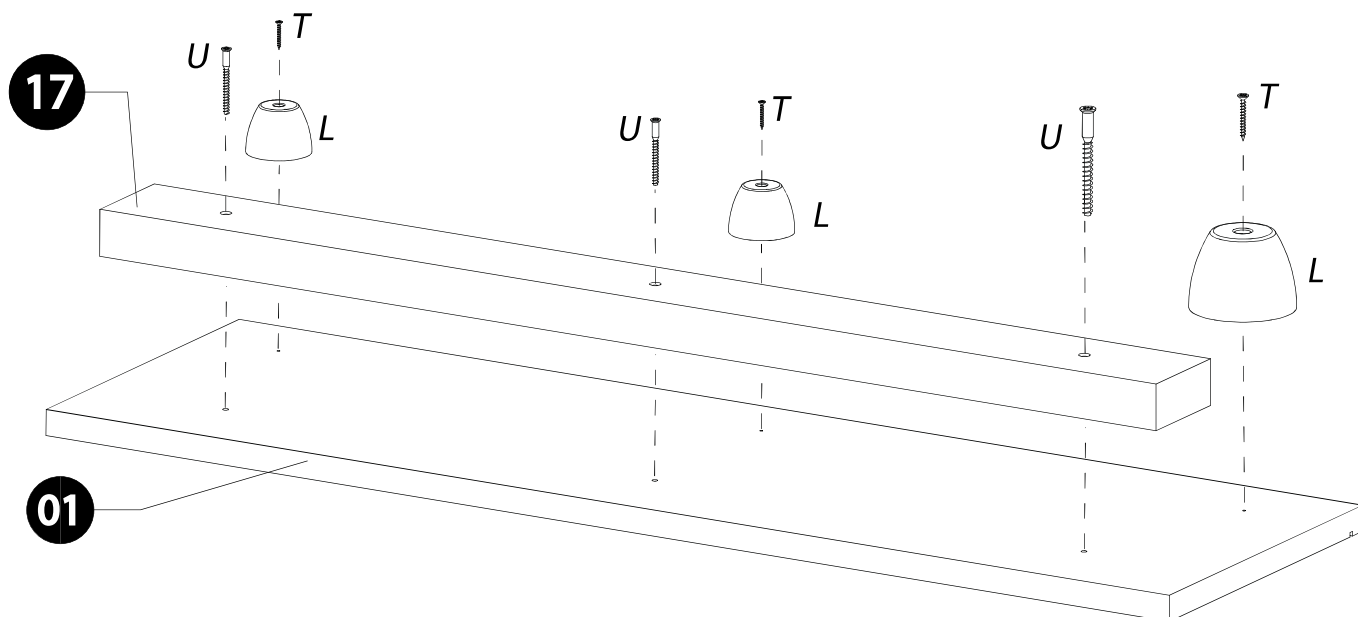
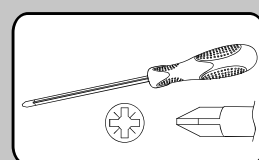
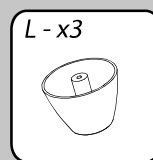
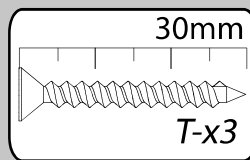
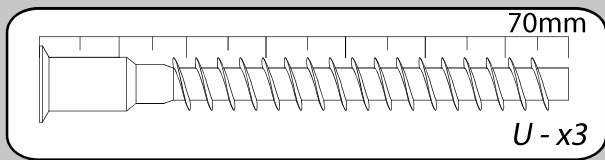

2

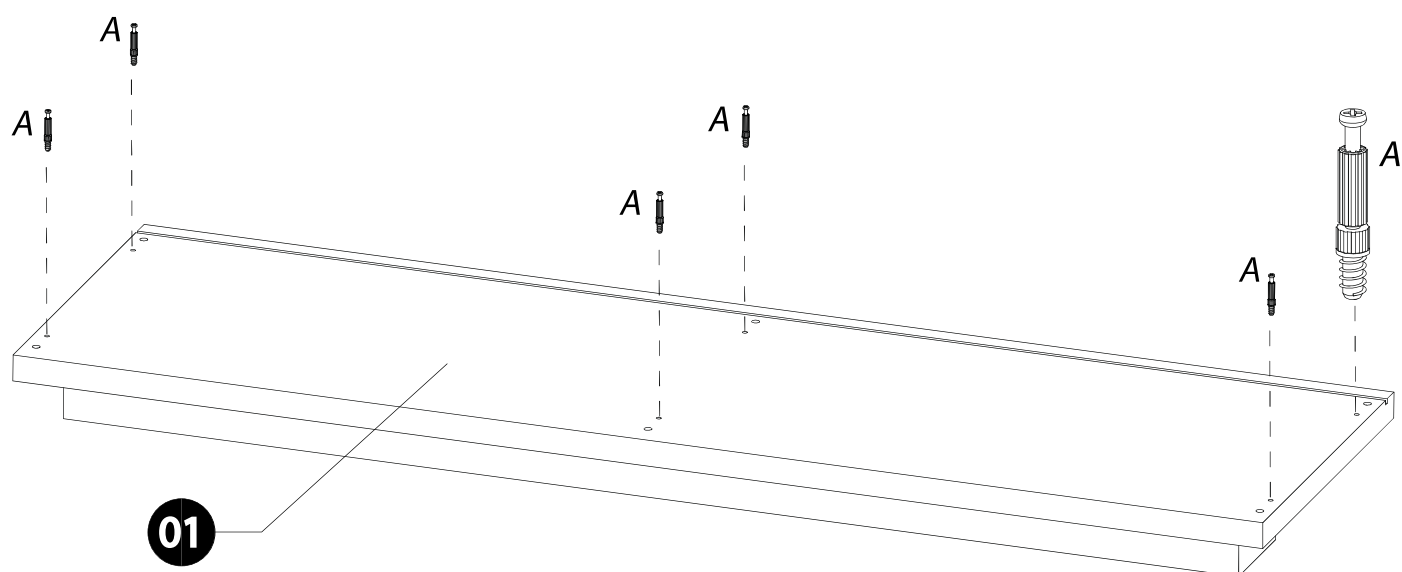
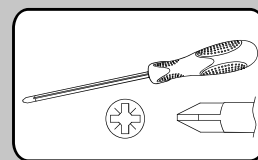
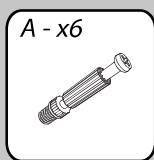

3

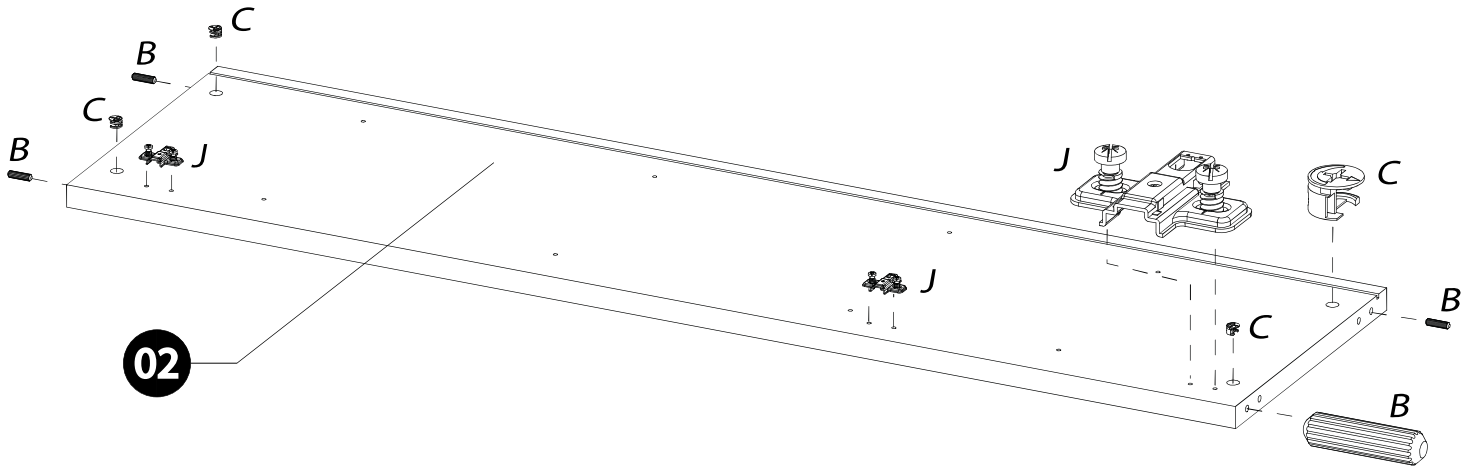
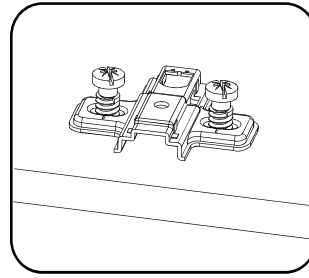
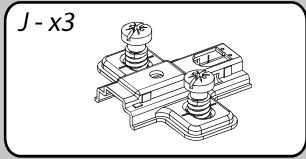
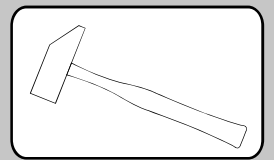
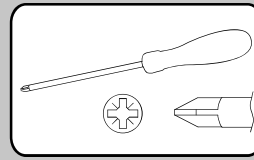
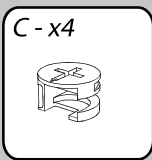
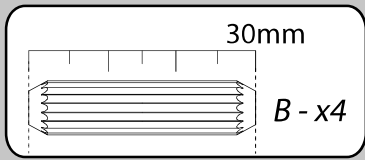

4

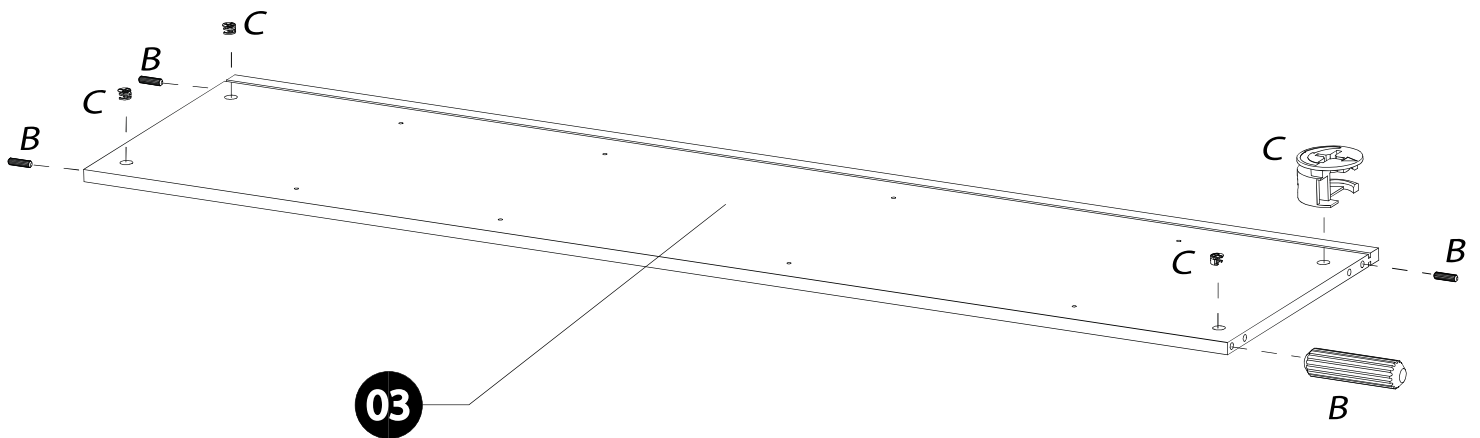
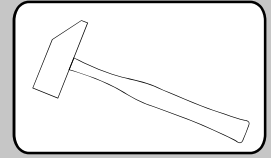
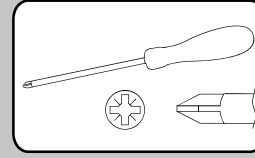
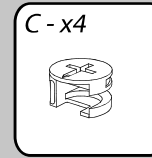
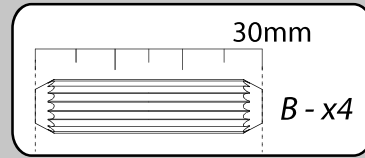

5

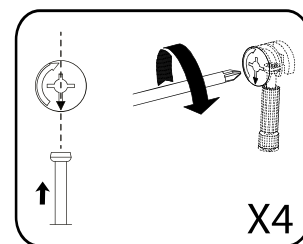
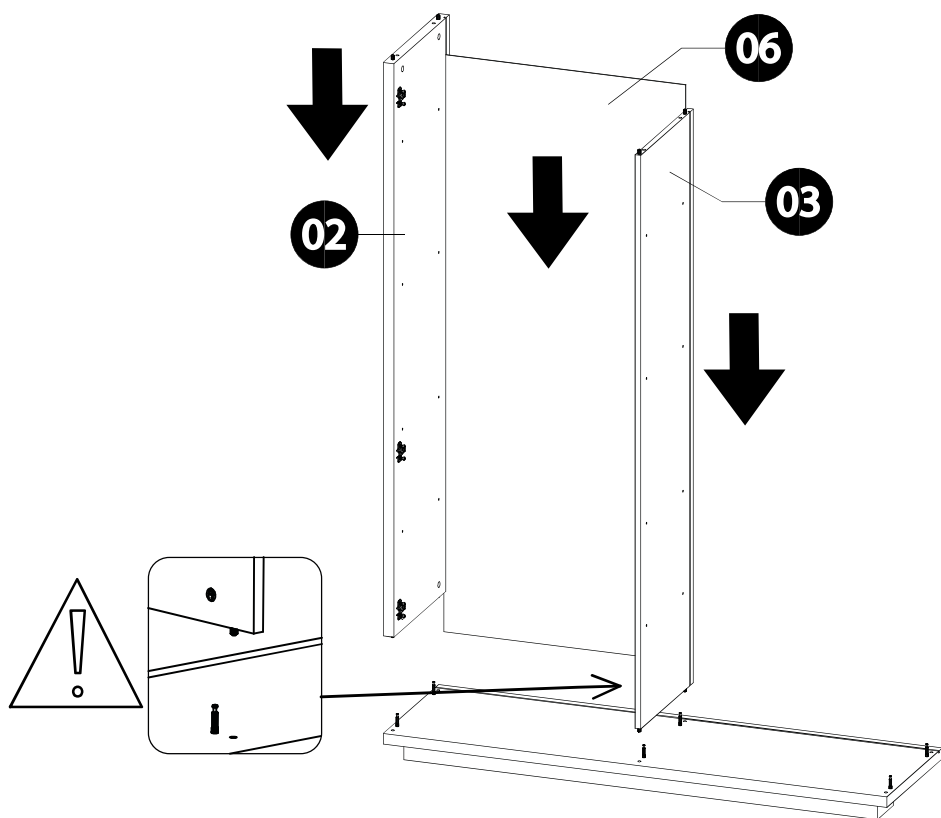
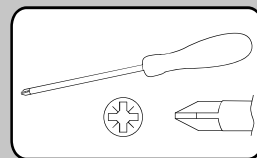

6

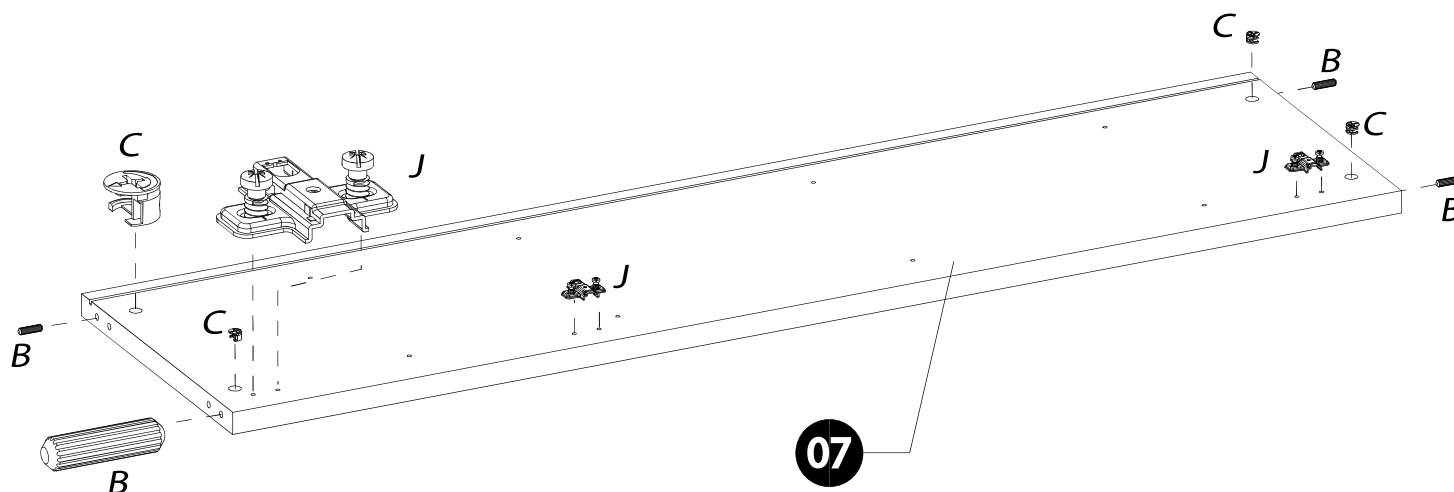
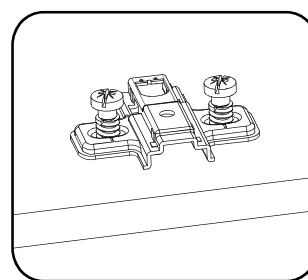
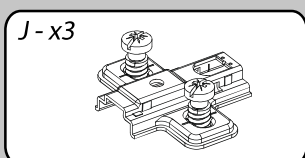
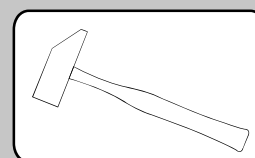
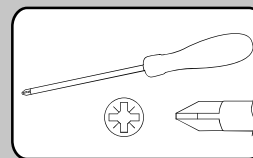
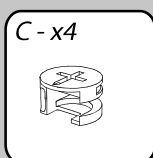
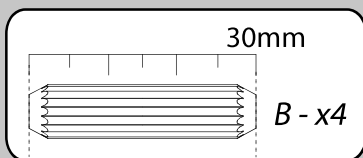

7

7

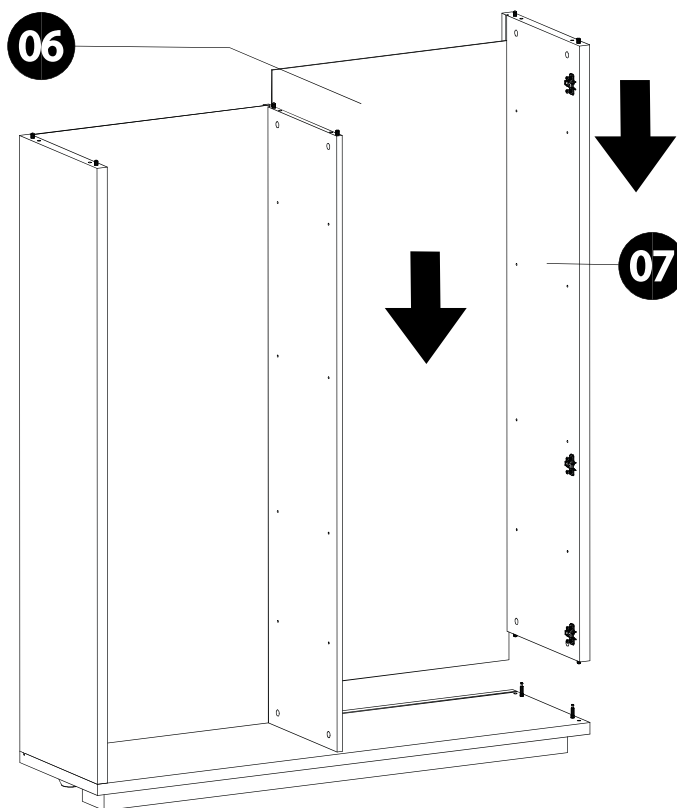
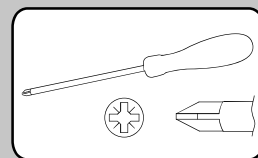

8

A - x6

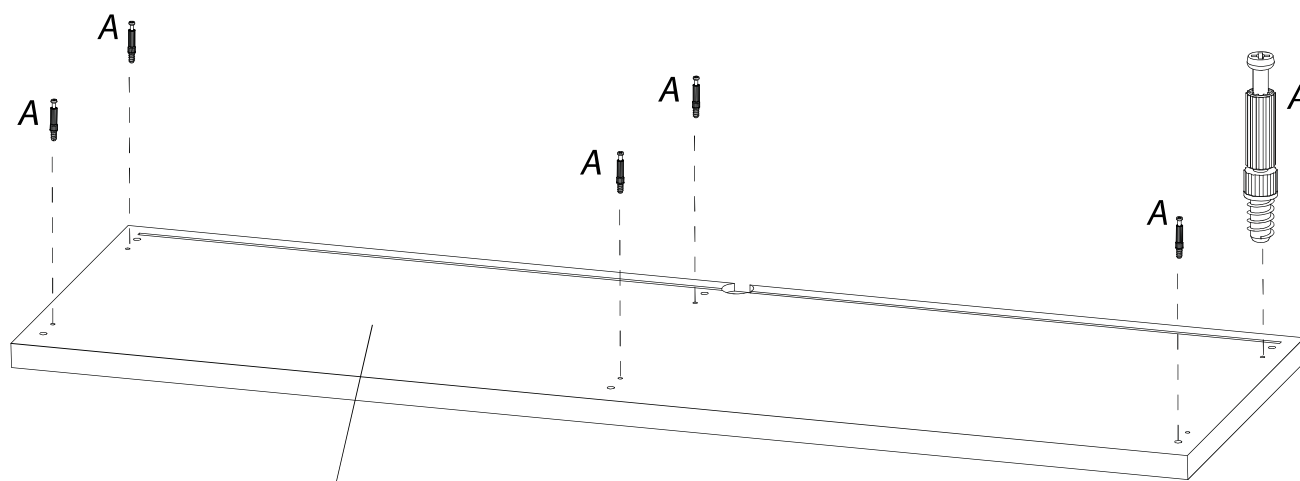
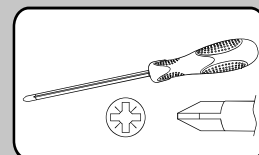
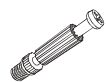

08

9

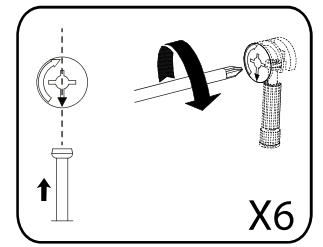
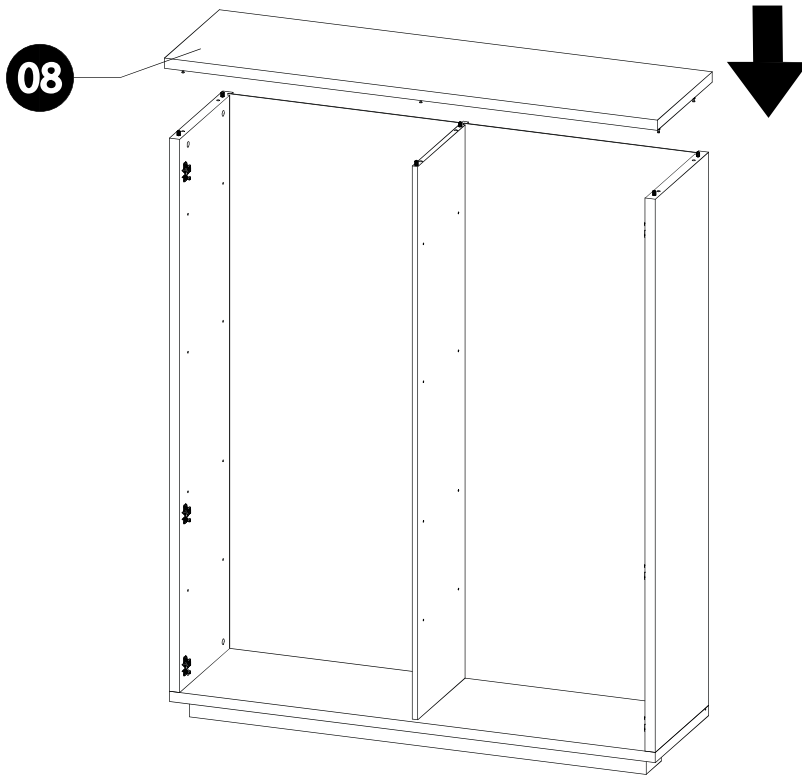
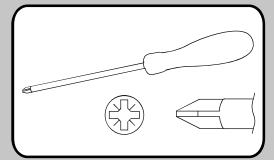

10

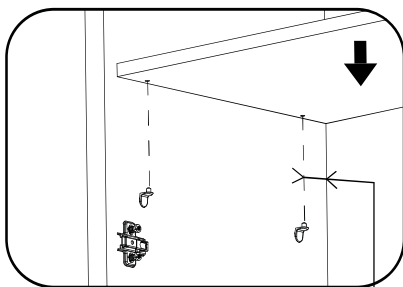
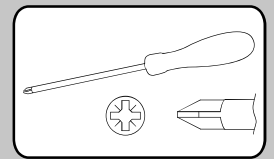
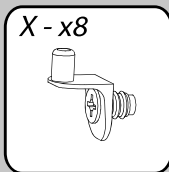

47mm

04

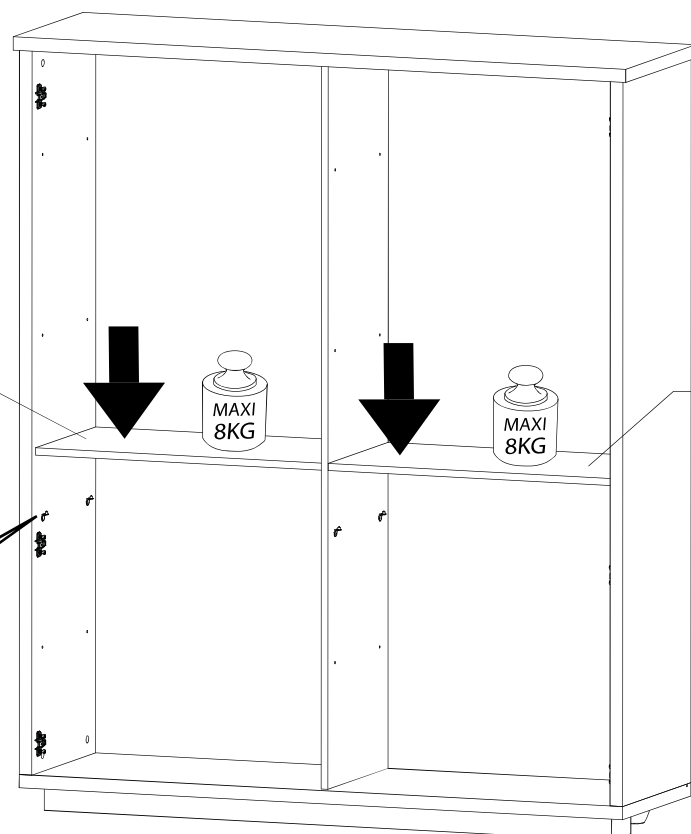

04

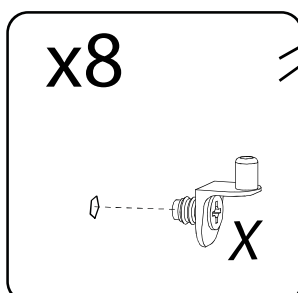

11

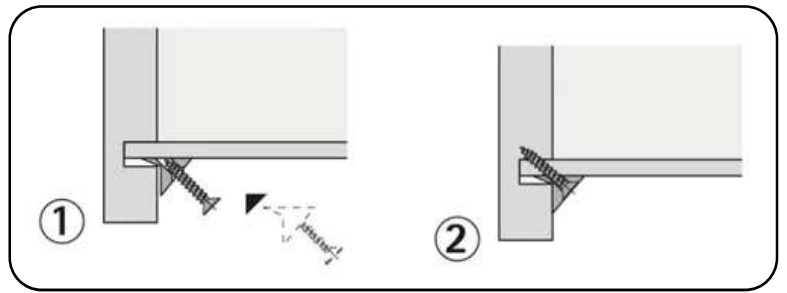
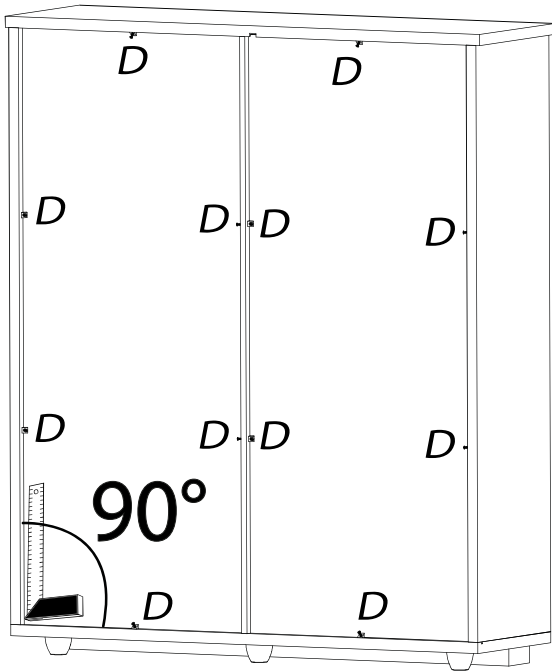
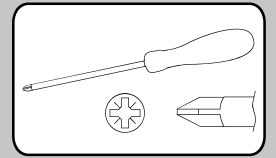
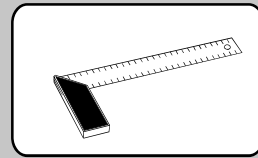
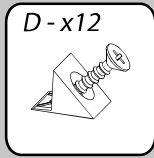

12

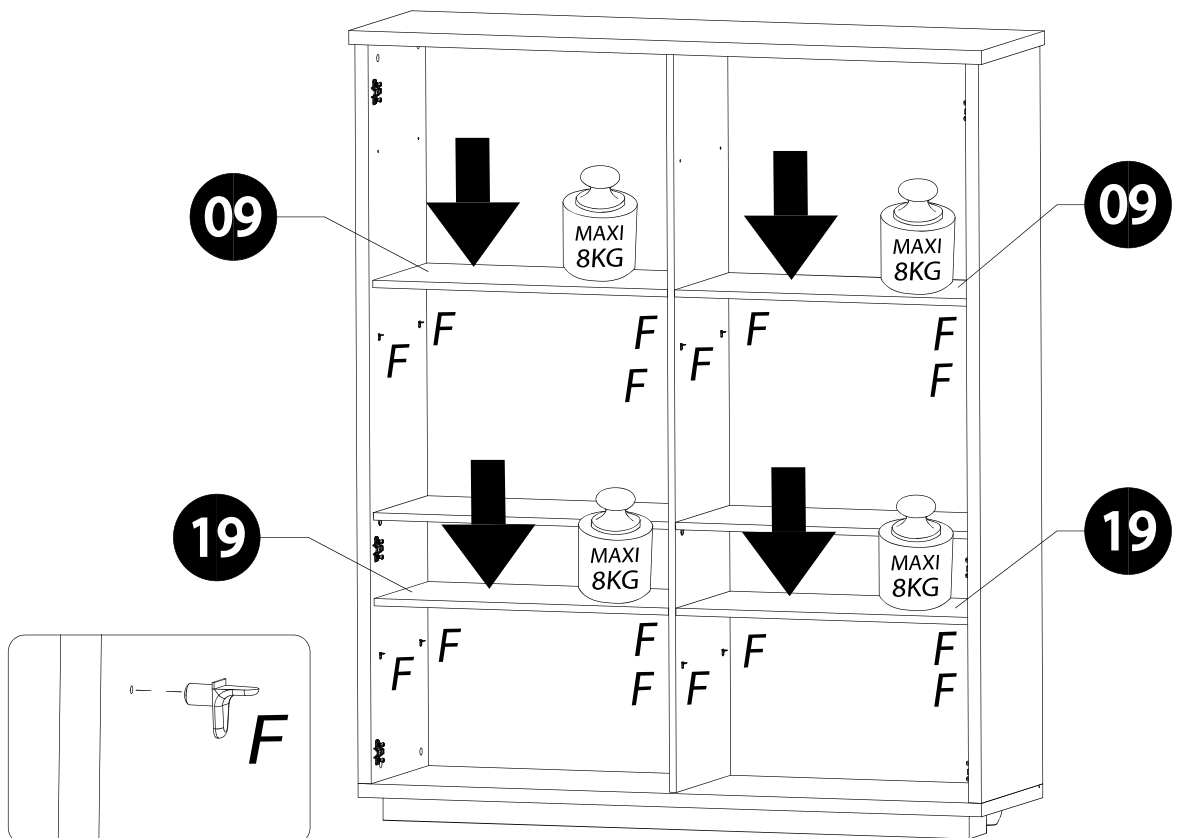
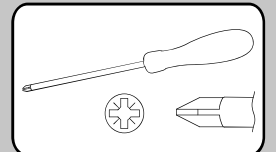
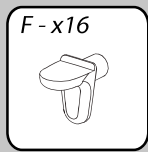

10

TERRA Rangement vitrine 2pg N°20

13

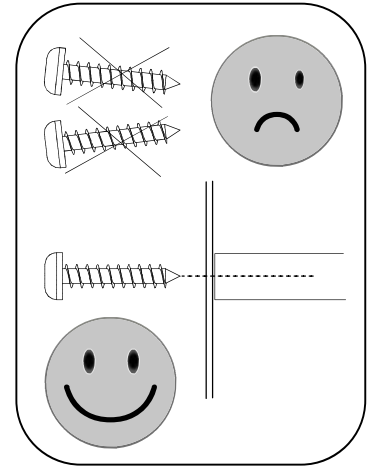
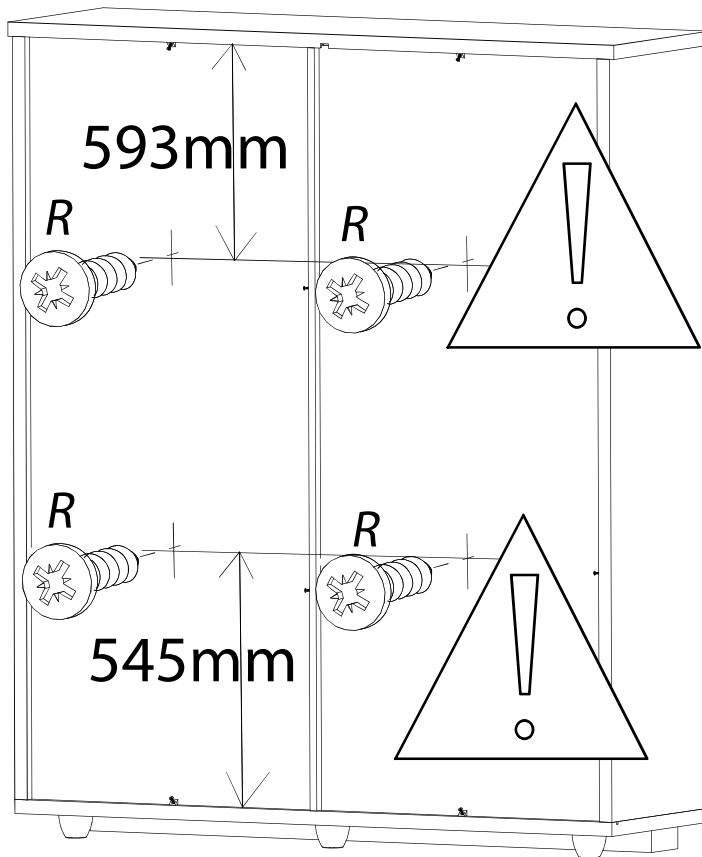
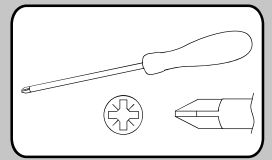
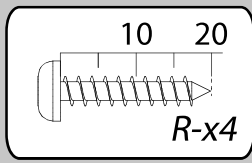

14

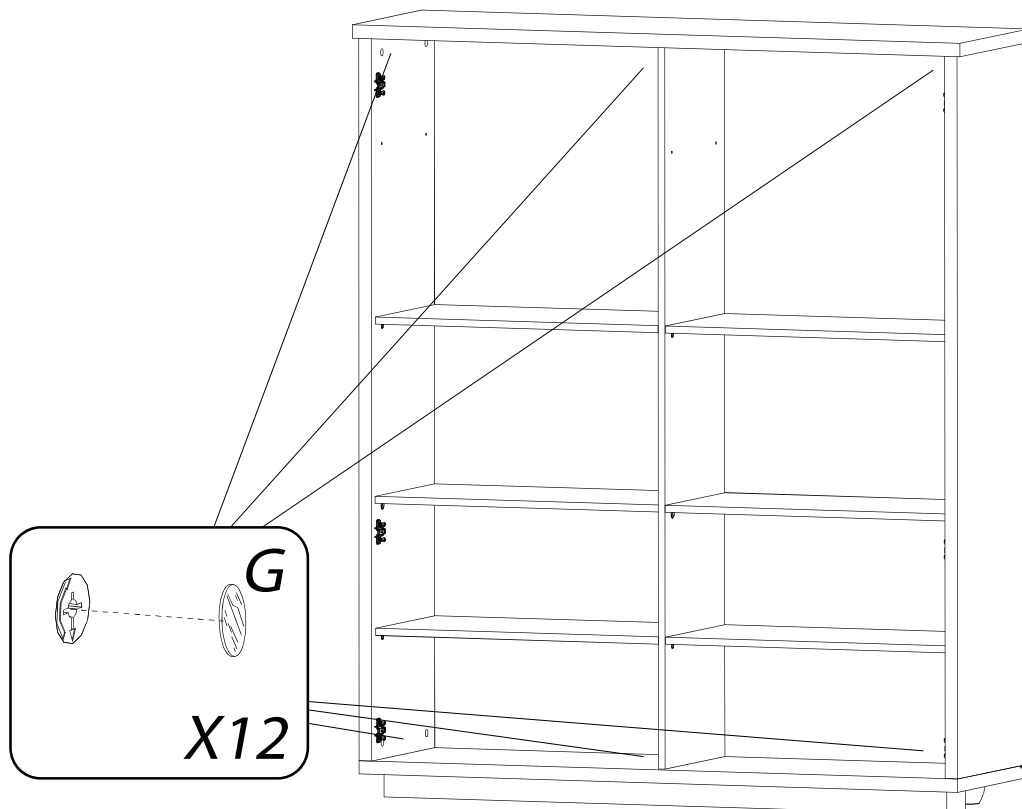
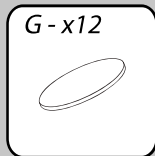

15

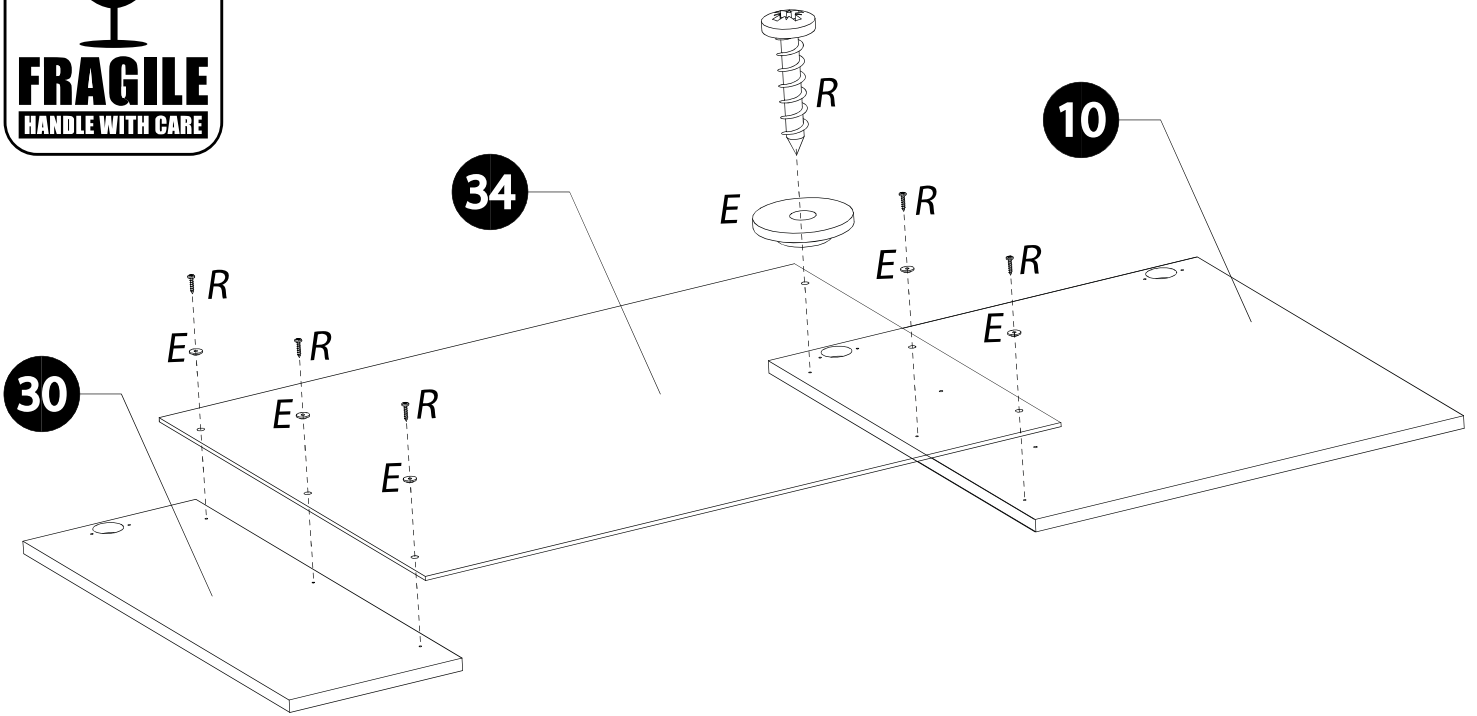
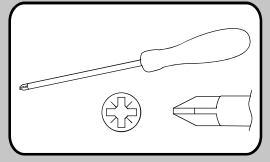
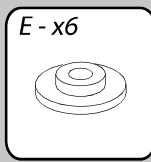
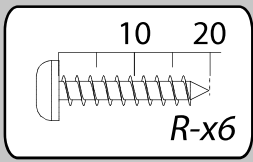

16

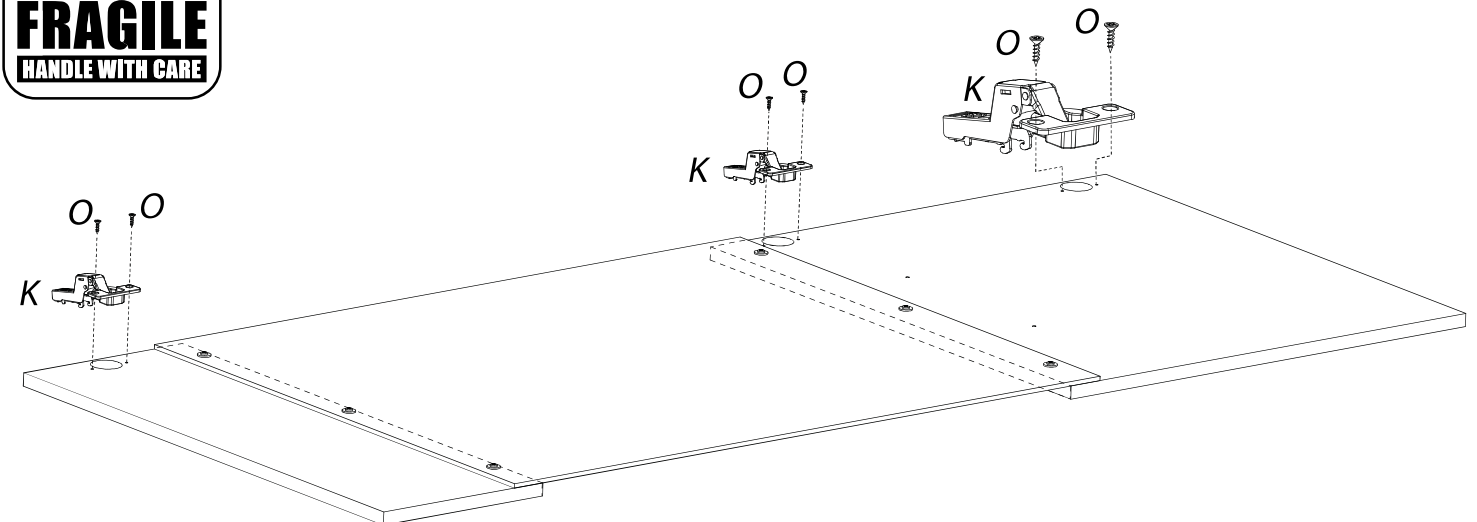
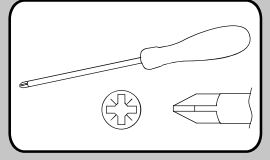
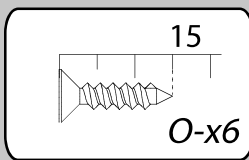
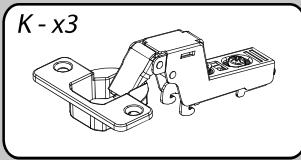

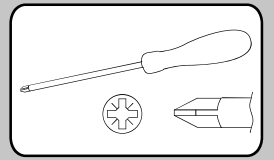

10

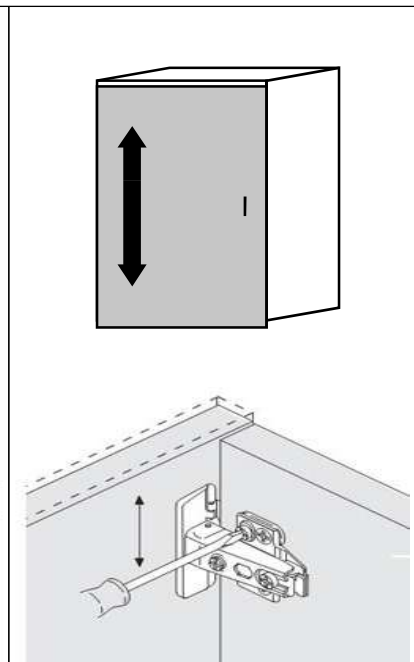
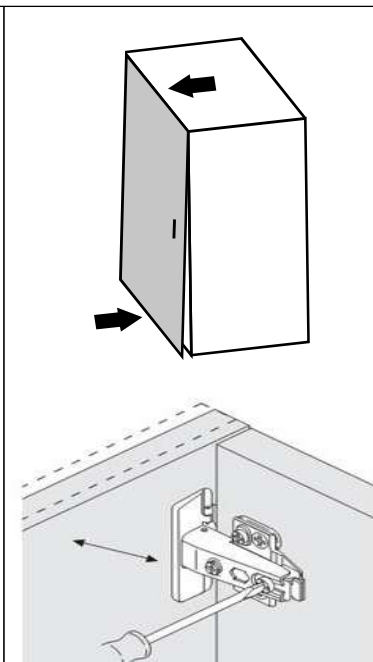
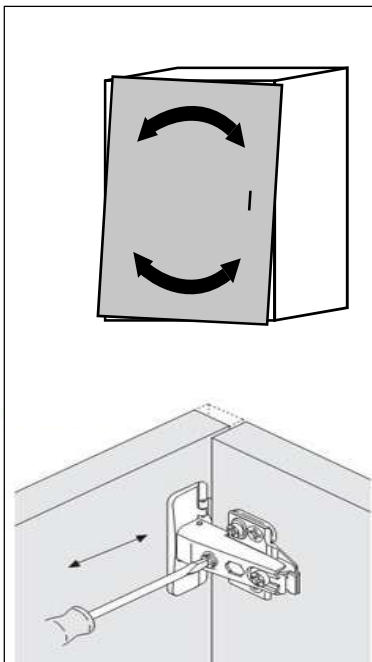
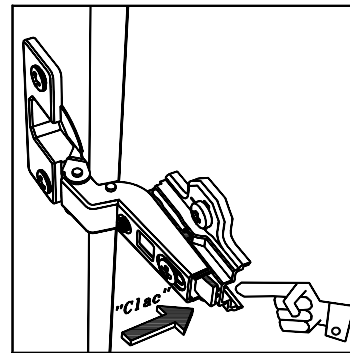
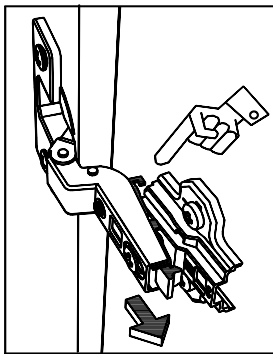
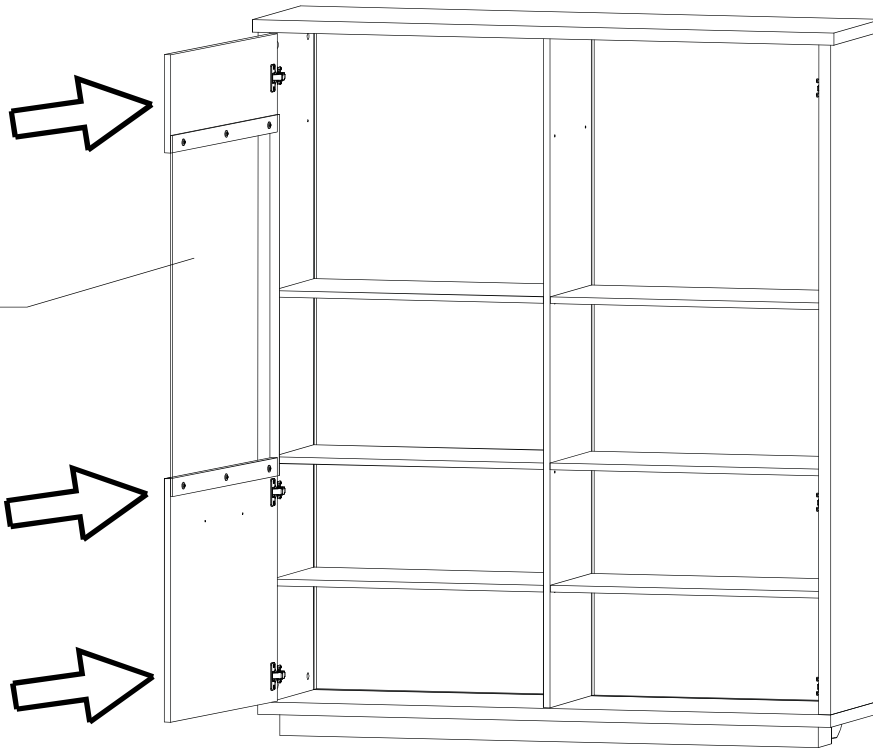

18

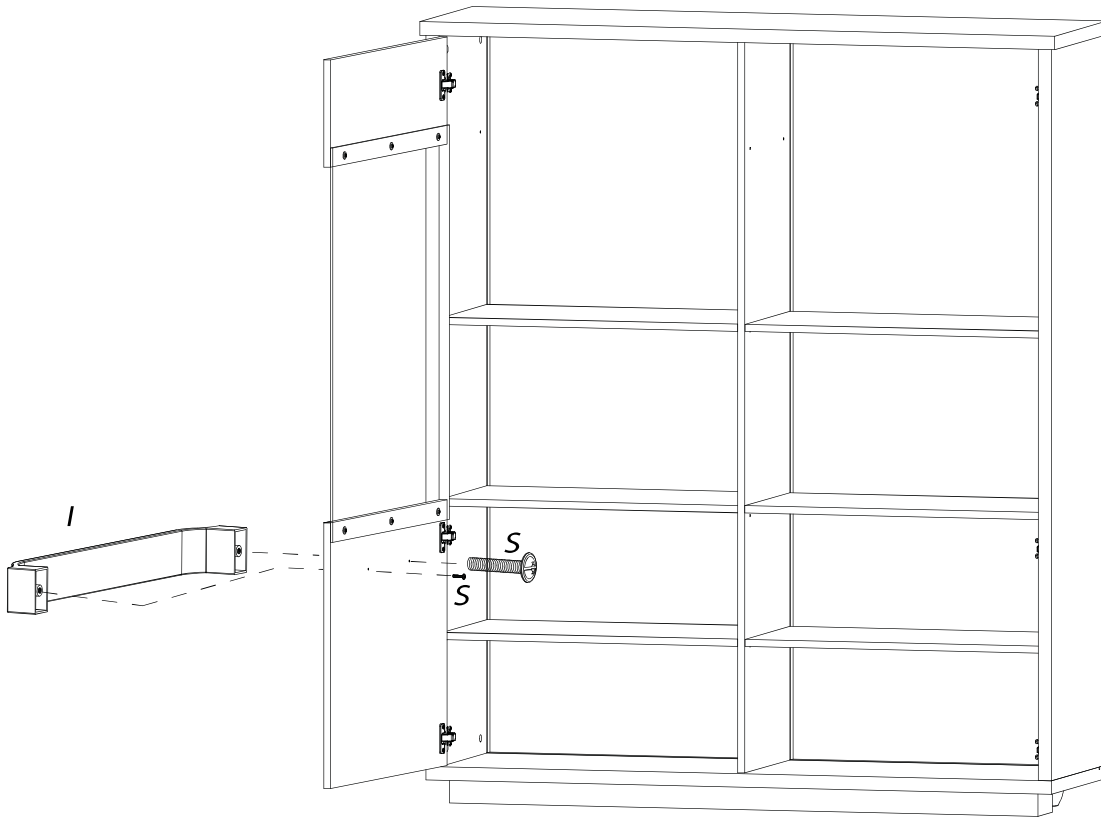
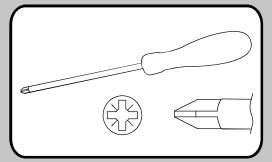
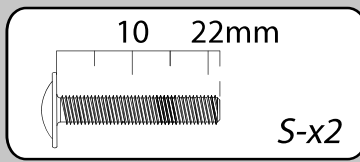
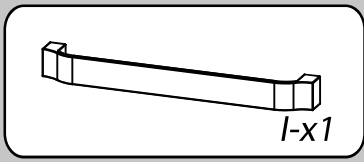

19

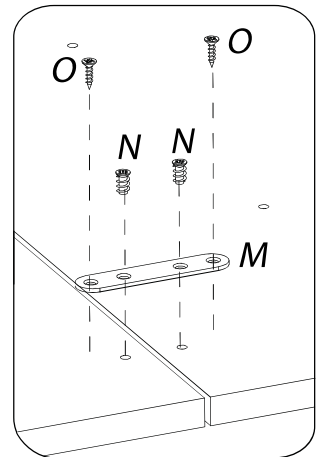
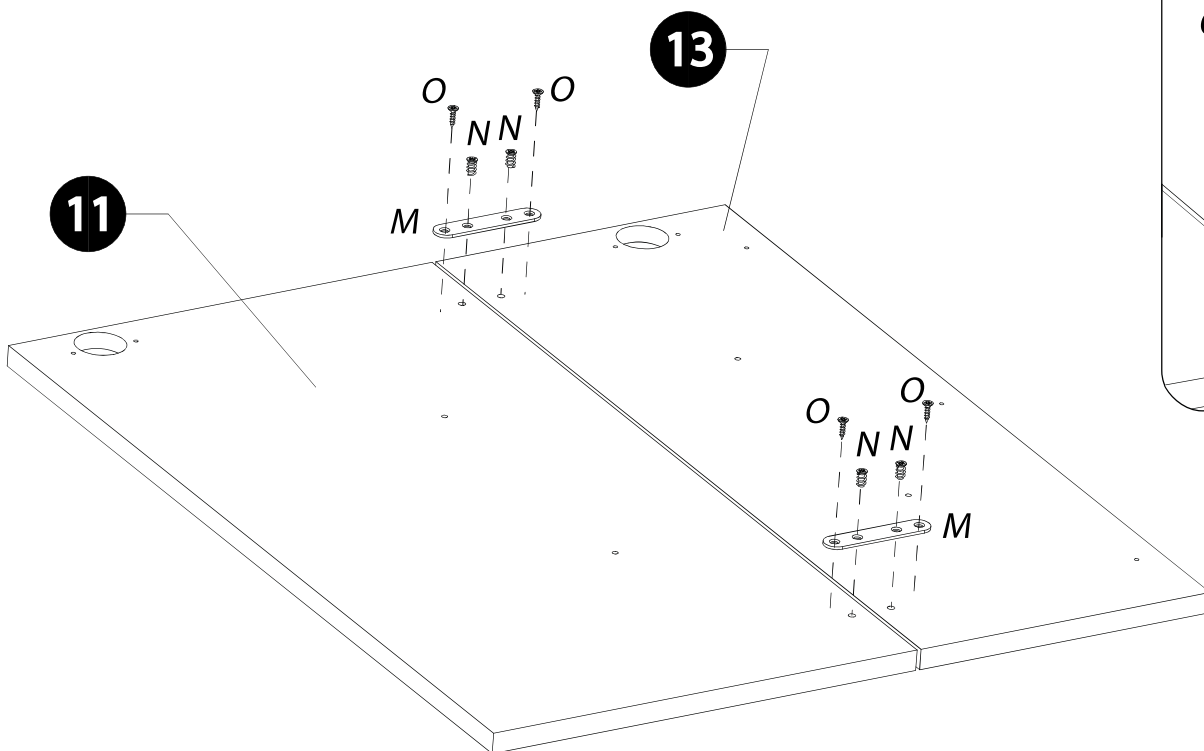
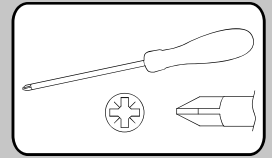
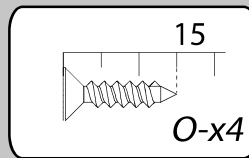
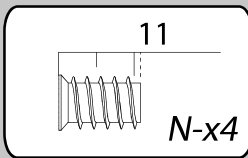
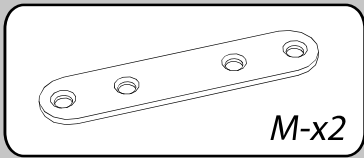

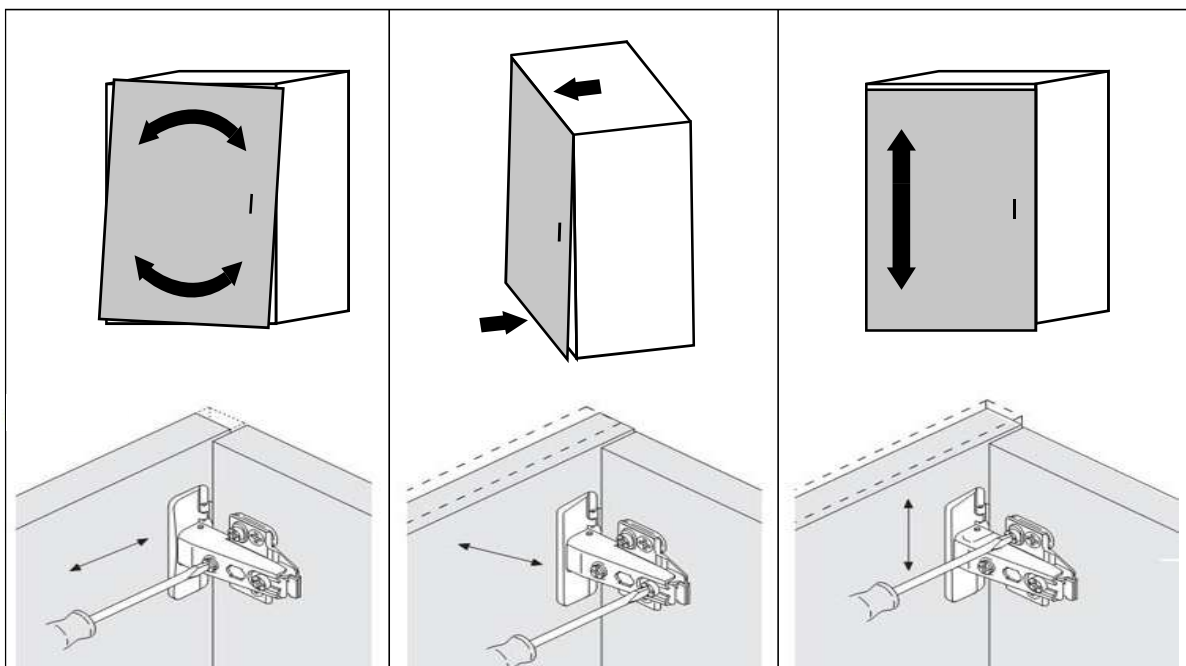
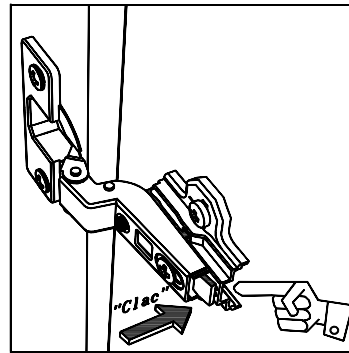
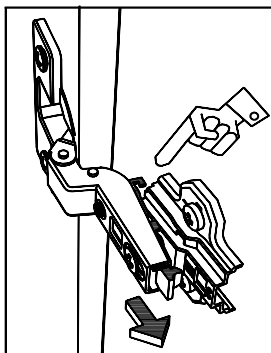
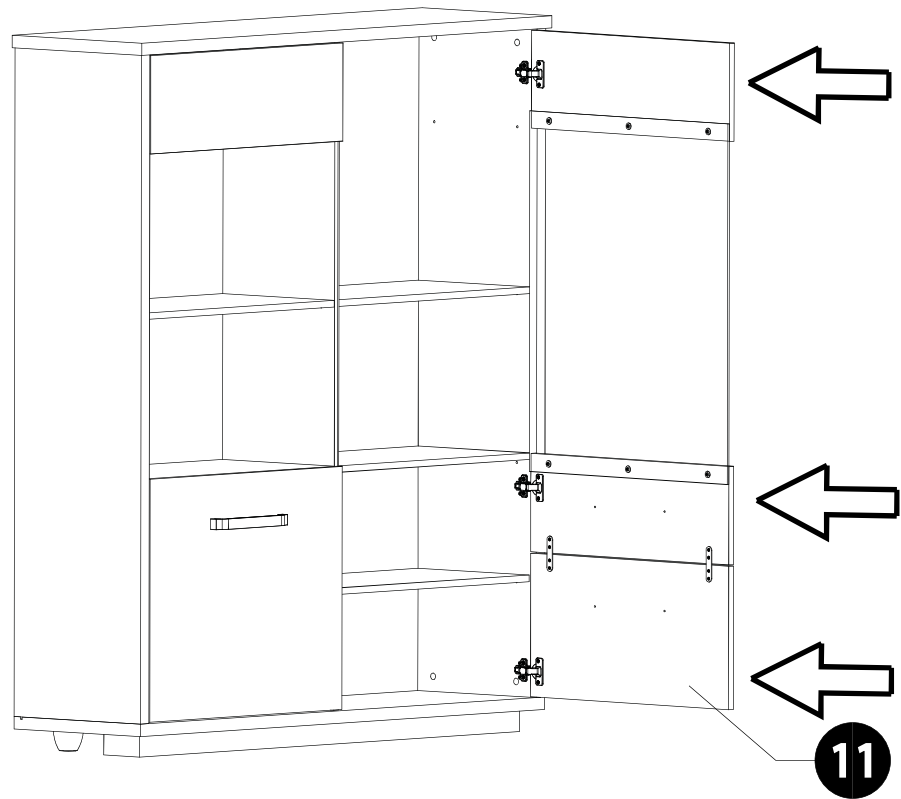
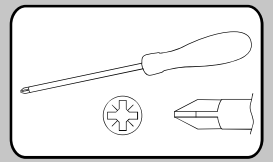

23

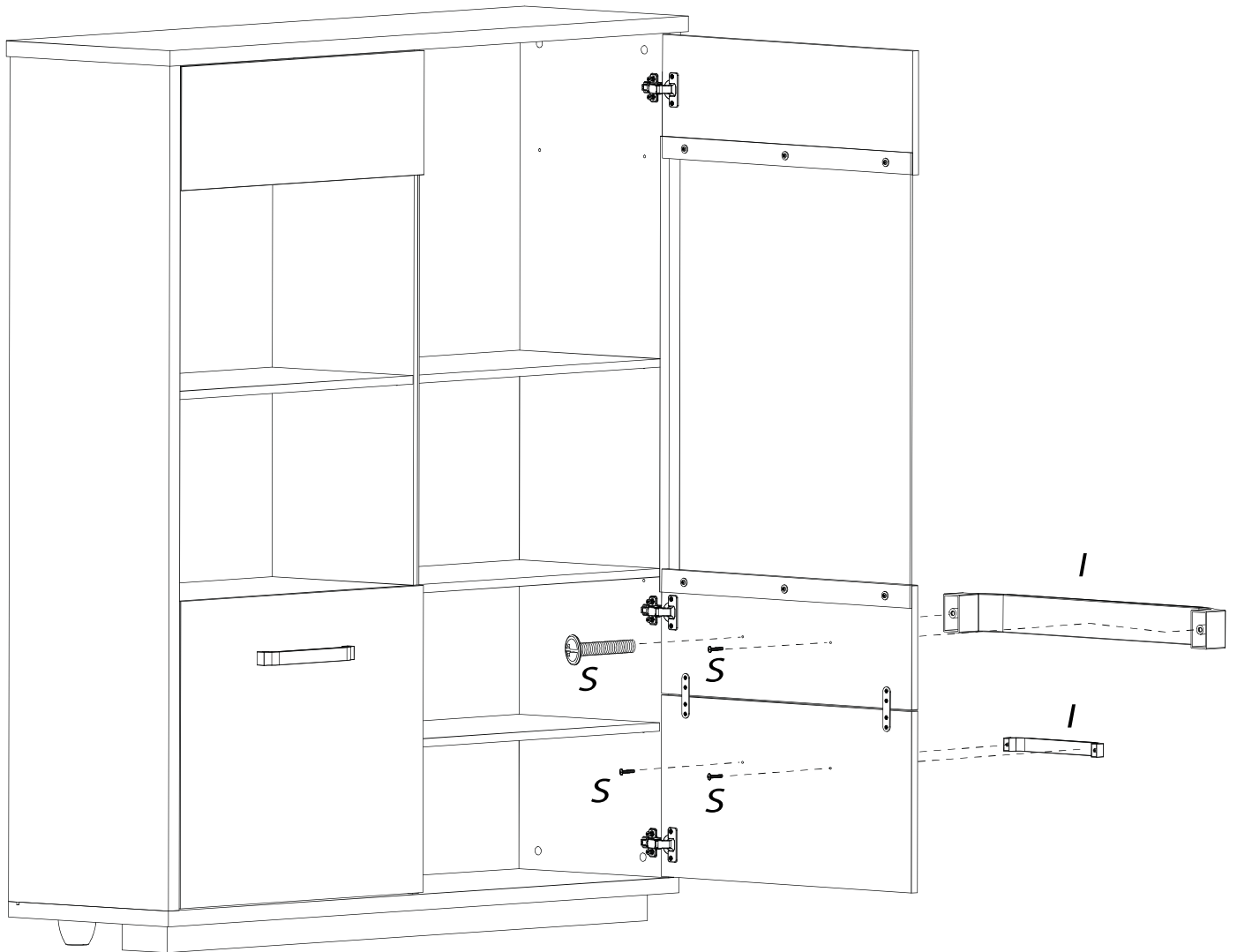
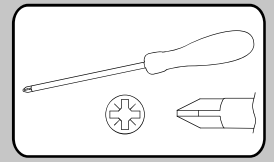
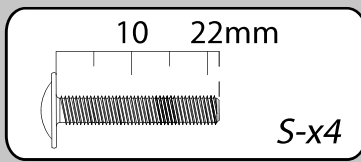
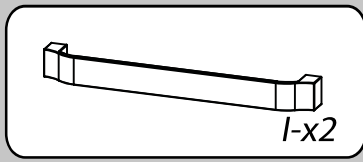

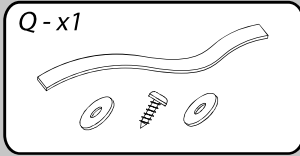

FRANCAIS: Pour votre sécurité il est impératif de fixer votre meuble au mur.
 Pour cela tous les meubles hauts disposent d'un dispositif d'accrochage, disponible à l'intérieure de votre colis.
 Si tel n'est pas le cas, veuillez en faire la demande auprès de votre revendeur.
 Cela empêche toute chute accidentelle du meuble.

ENGLISH: For your safety it is compulsory to fix your furniture to the wall.
 For this reason, all the high cabinets have a hanging system, available inside your package.
 If this is not the case, please contact your reseller.
 This prevents any accidental falling of the furniture.

DEUTSCH: Zu Ihre Sicherheit muss Ihre Möbel an der Wand befestigt.
 Aus diesem Grund verfügen alle Hochschränke über eine Aufhängevorrichtung, die in der verpackung steht.
 Falls nicht, bitte verwenden sie sich an ihren Händler.
 Es vermeidet jede zufällig fallen.

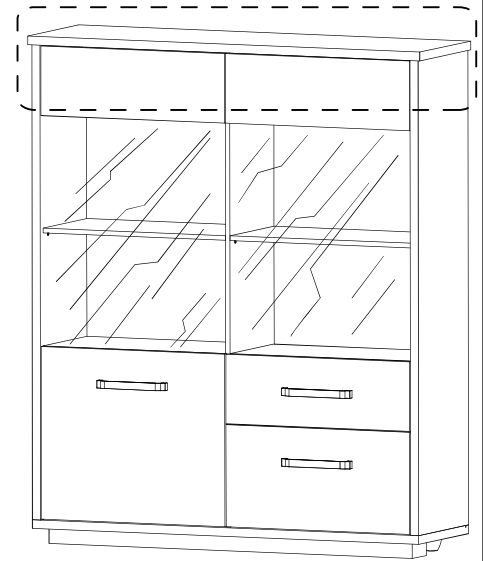
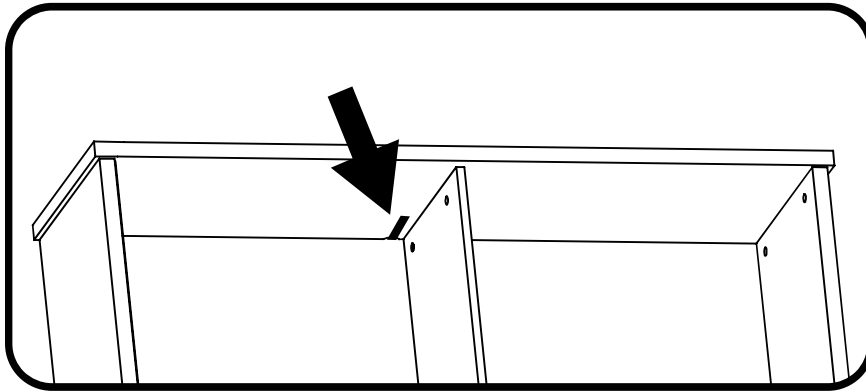

FRANCAIS
IMPORTANT: La vis fournie avec le dispositif anti-basculé est destinée à fixer le dispositif dans le meuble.
 Pour la fixation au mur, compléter par une vis adaptée au support mural.
 En cas de doute, contacter un magasin de bricolage.

ENGLISH
IMPORTANT: The screw supplied together with the anti-topple bracket is to be used only for fixing the anti-topple bracket to the furniture.
 In addition to this, you will need to choose a screw or fitting which is suitable for securing the bracket to the kind of walls you have. If you are unsure about what type of screw to use contact your local hardware store.

DEUTSCH
WICHTIG: Die dem kippschutz beigefügten schrauben sind ausschließlich für die befestigung des kippschutzes am möbelstück vorgesehen. Für die befestigung des kippschutzes an der wand benötigen sie zusätzlich schrauben oder beschläge, die zur beschaffenheit der wand passen. Falls sie nicht sicher sind, welche art von schrauben geeignet sind, wenden sie sich bitte an den fachhandel.

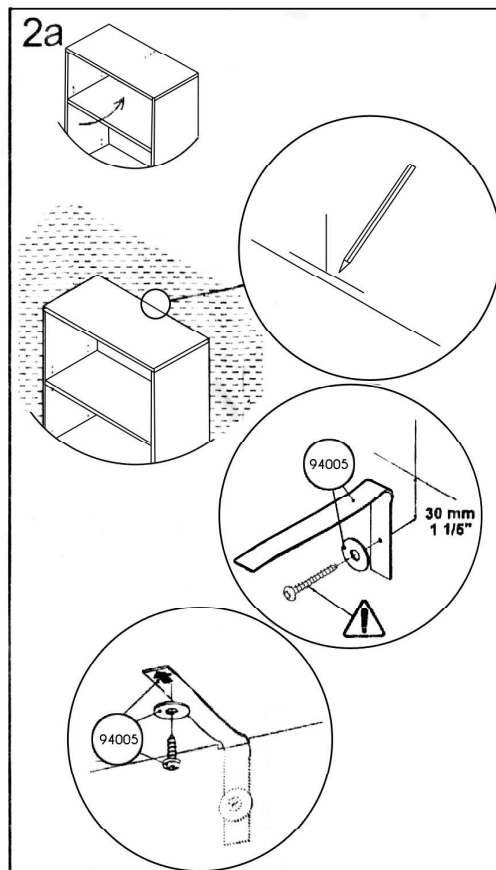
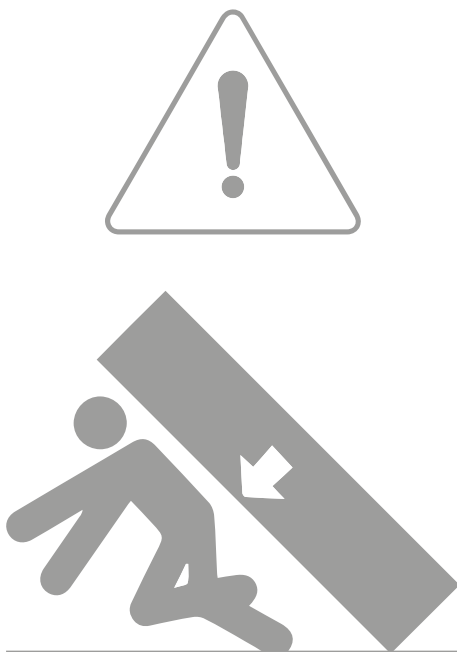

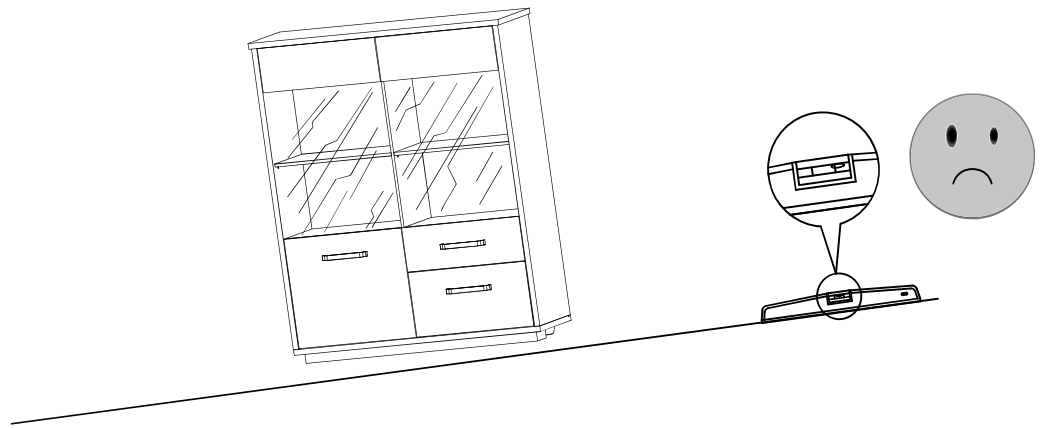
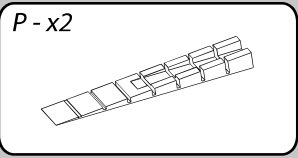

- **FRANCAIS** - Recommandations de démontage :

En cas de déménagement, il convient de procéder au démontage de votre meuble, en ôtant toute la visserie.

- **ENGLISH** - Disassembly advices:

In case of moving, it is needed to dismantle the furniture removing the fittings.

- **DEUTSCH** - Empfehlungen für die Demontage:

Bei Transport bitte alle Beschläge demontieren.



"Les meubles contenant des panneaux à base de bois (panneaux de particules, panneaux de fibres, contreplaqué...) peuvent émettre des substances polluantes dans l'air intérieur. Il est ainsi recommandé, après l'installation du meuble dans son logement, d'aérer fréquemment la pièce concernée pendant au moins quatre semaines afin de réduire son exposition aux polluants émis par le meuble."