

# ASSEMBLY INSTRUCTION

55127

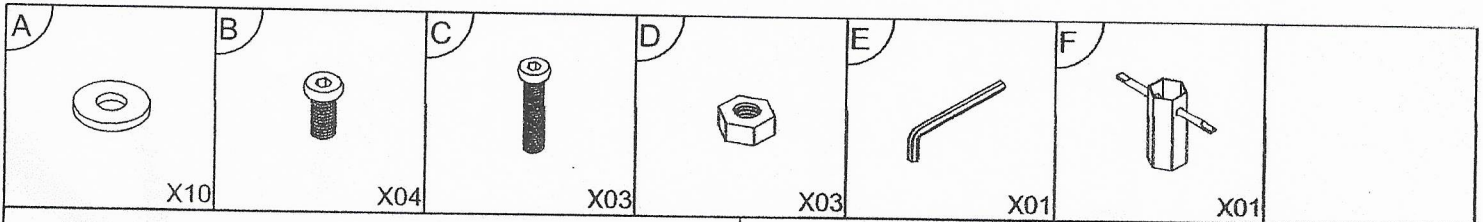

1

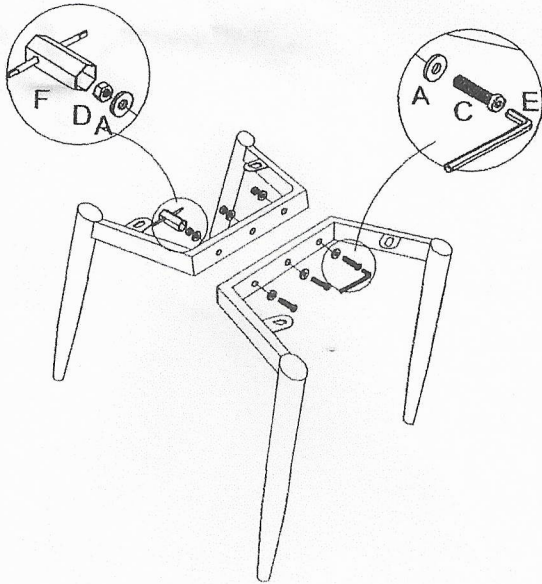
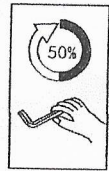

2

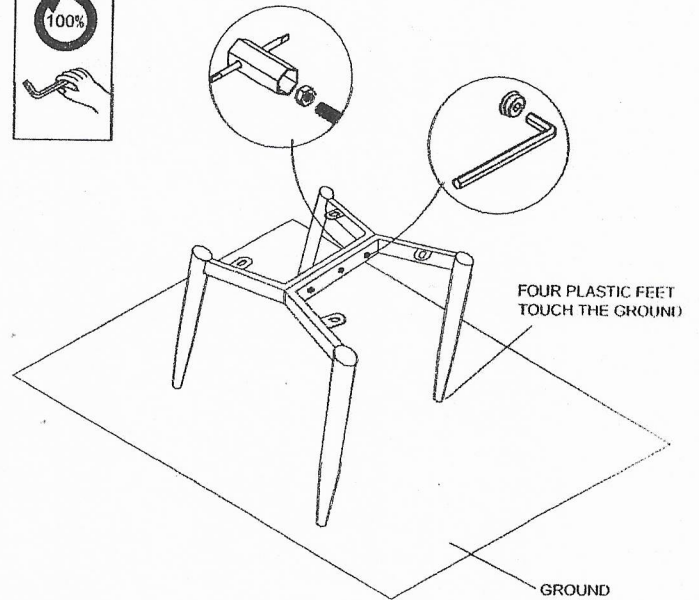

3

