









A		4pcs	E		8pcs
B		4pcs	F		8pcs
C		4pcs	G		1pcs
D		1pcs			



Complete!

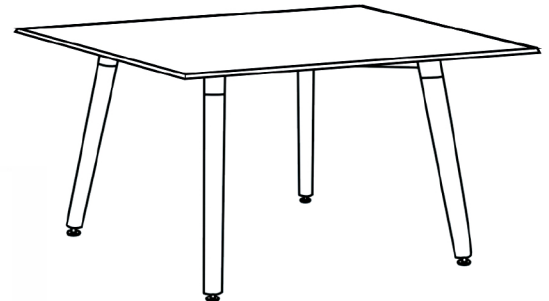
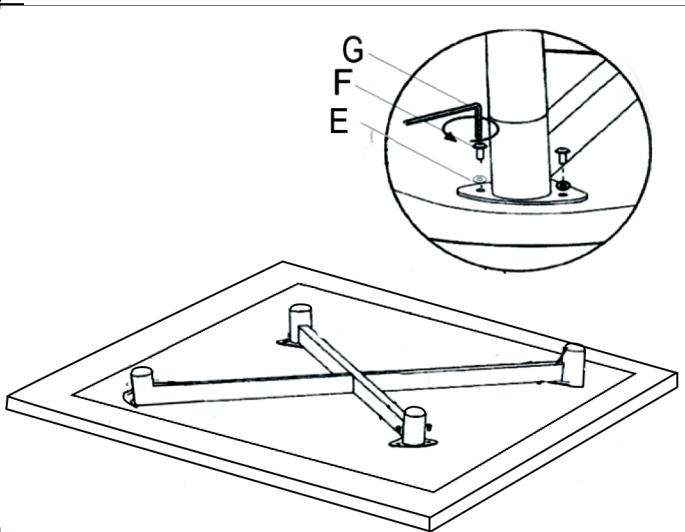

Dévissez les vis « F » à l'aide de la clé « G », puis retirez les rondelles métalliques « E ».

1

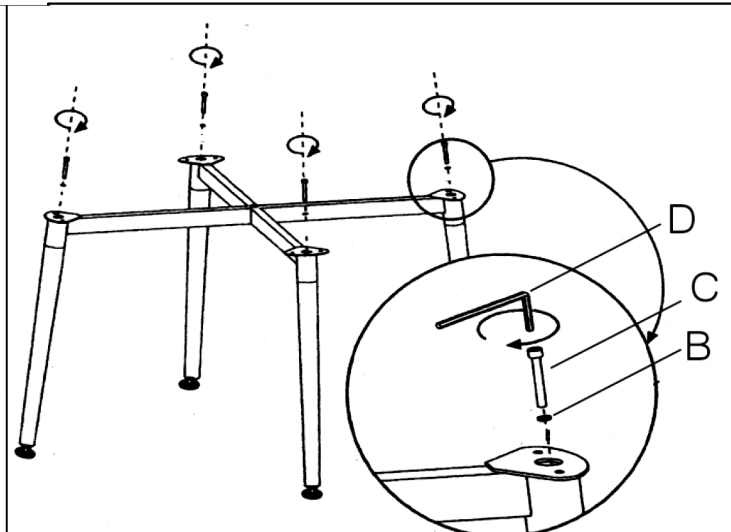



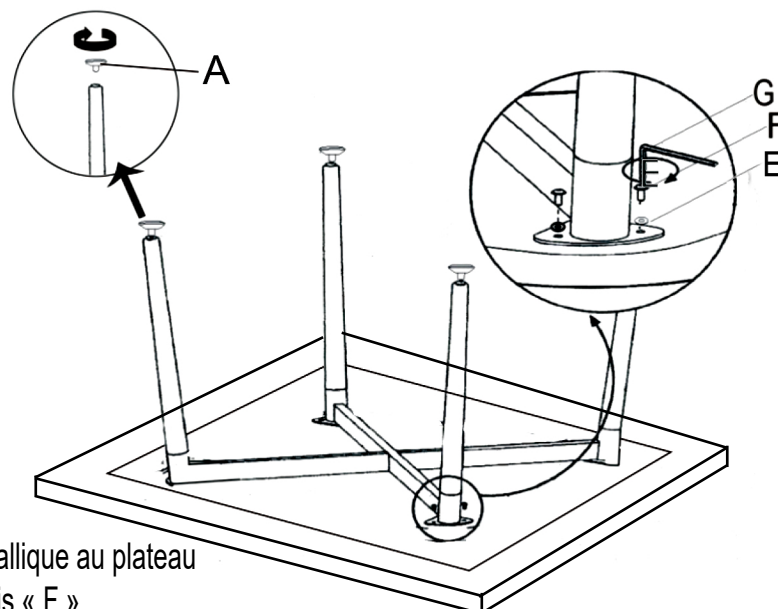





2



Assemblez le cadre métallique au plateau de la table à l'aide des vis « F » et des rondelles métalliques « E » de l'étape 1.

3

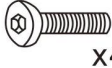

A	 x1	D	 x5	G	 x1
B	 x1	E	 x1	H	 x2
C	 x1	F	 x4	I	 x1



Complete!

1

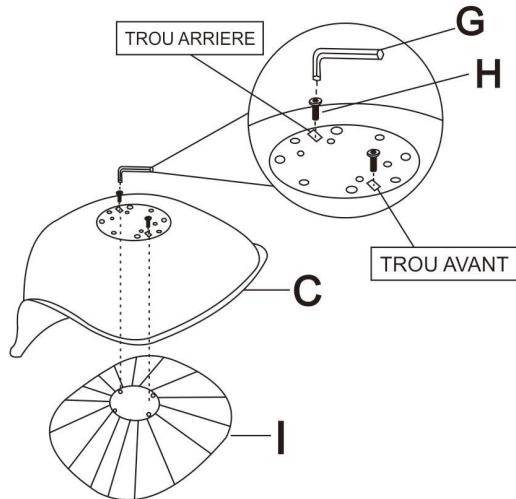

En premier, insérez la vis « H » dans le trou arrière en serrant à 80 %, puis insérez l'autre vis « H » en serrant à 80%, et enfin serrez complètement les deux vis à 100 %.

2

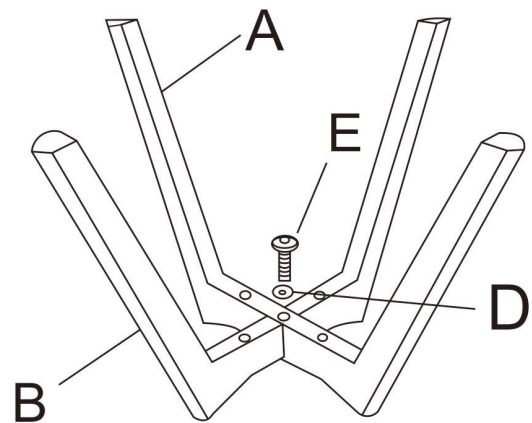

3

