

# MANUEL D'ASSEMBLAGE

AX 1

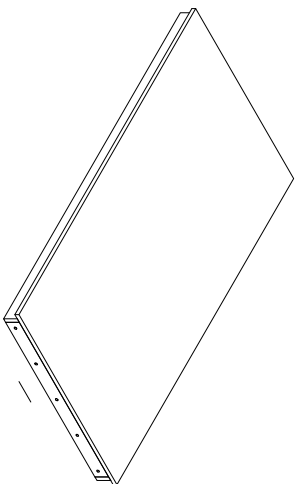

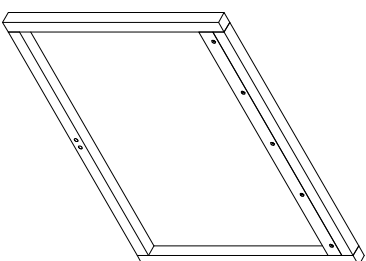

B X 2

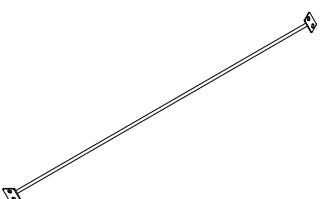

C X 2



①	Boulon M8x20		16
②	Rondelle Ø8xØ19		16
③	Clé		1

Etape 1

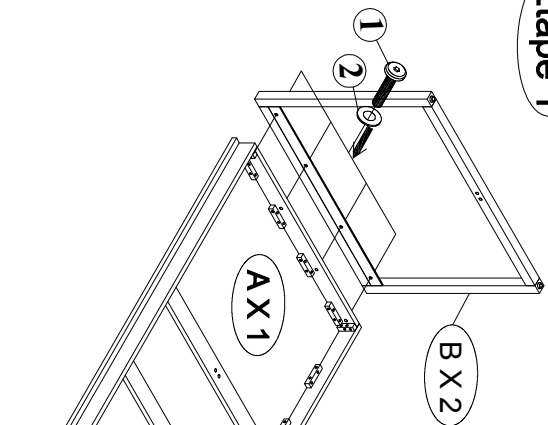

Etape 2

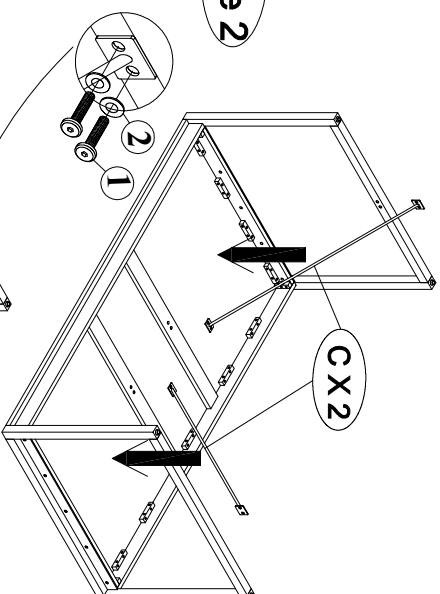

Etape 3

