

- FR** NOTICE DE MONTAGE
- EN** ASSEMBLY INSTRUCTIONS
- DE** MONTAGEANLEITUNG
- ES** INSTRUCCIONES DE MONTAJE
- NL** MONTAGEVOORSCHRIFT
- IT** ISTRUZIONI DI MONTAGGIO
- PT** INSTRUÇÕES DE MONTAGEM
- PL** INSTRUKCJA MONTAŻU
- CR** NAPUTCI ZA MONTAŽU

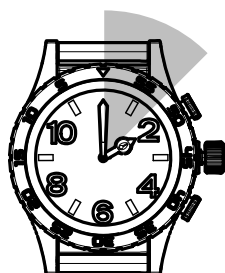

1h30.

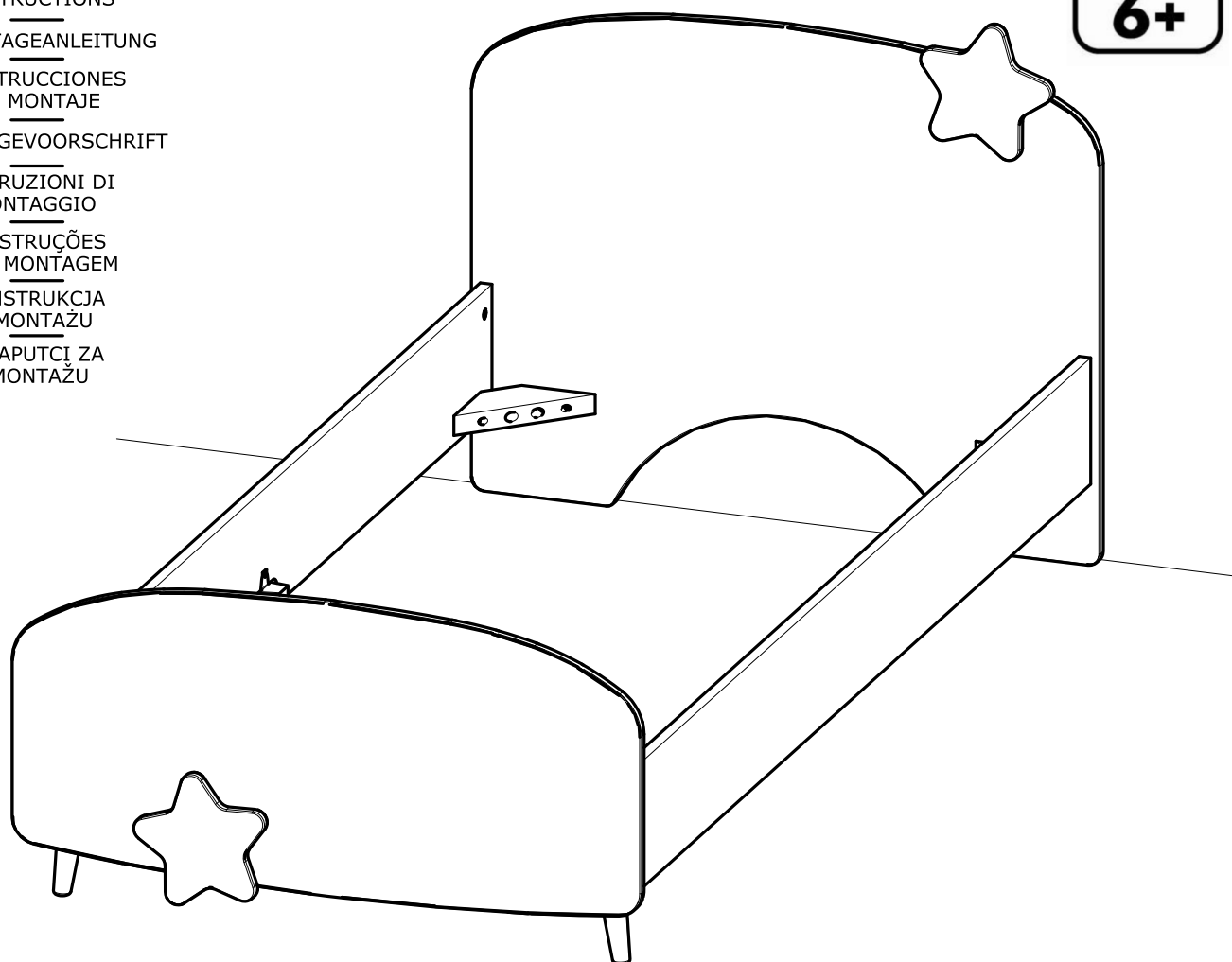
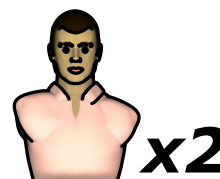

x2



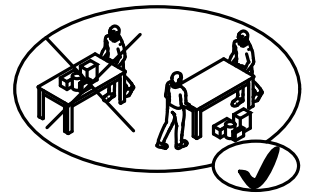
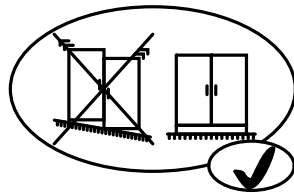
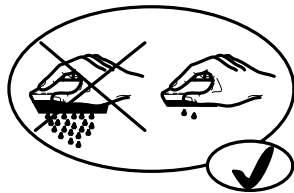
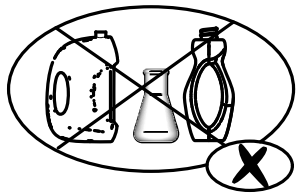
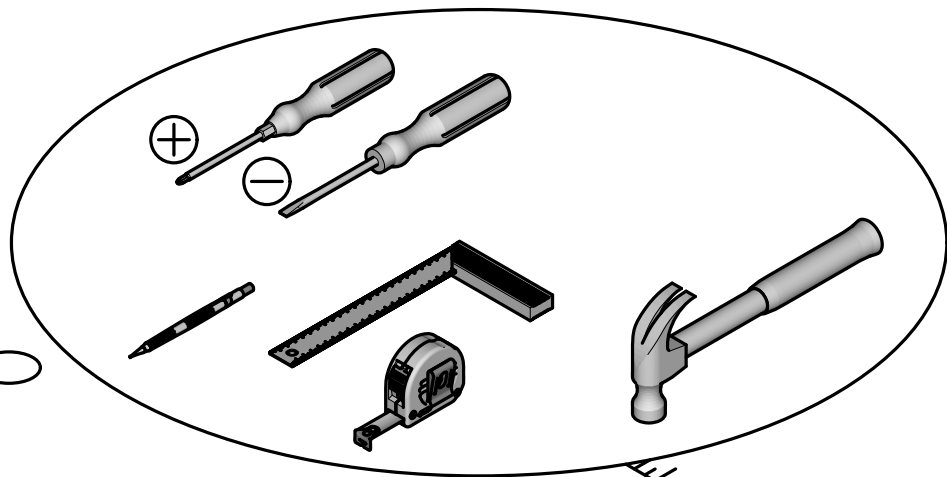
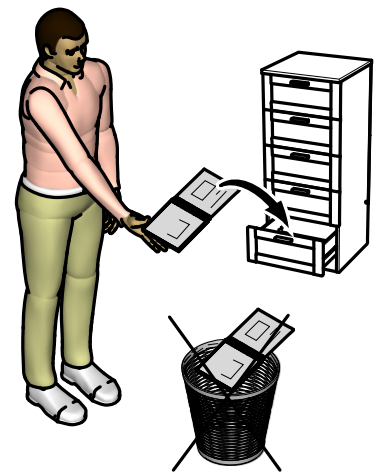
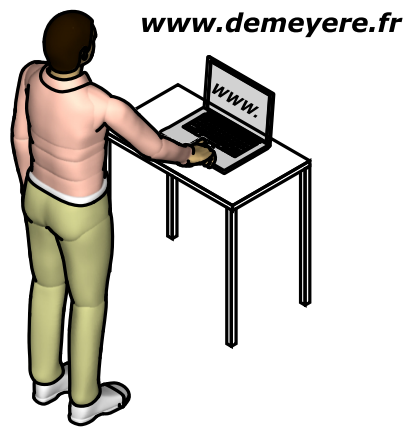



C x8

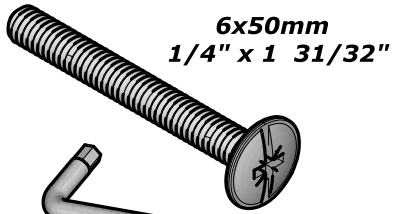

D x1

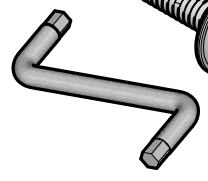

E x4



F x8



G x8

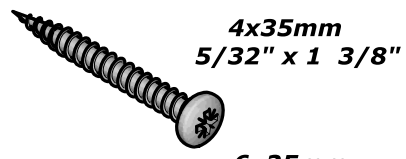

H x4

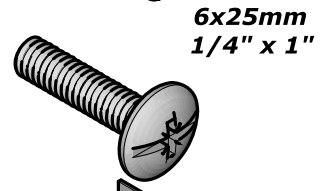

I x2

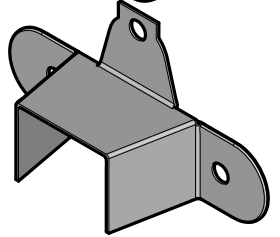

J x2

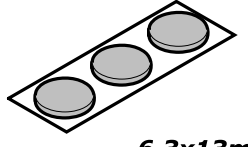

K x6

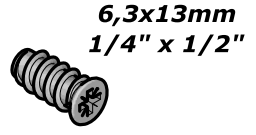

L x4

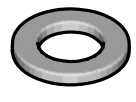

M x4

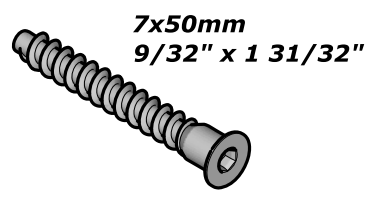

N x2

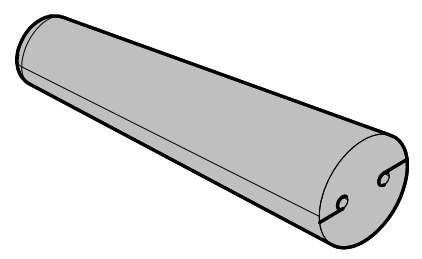

O x2

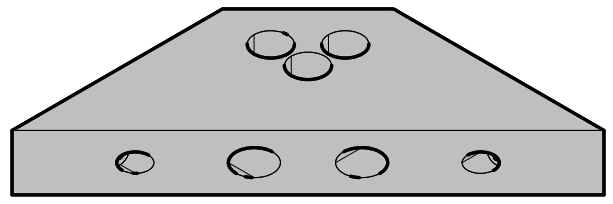

P x2

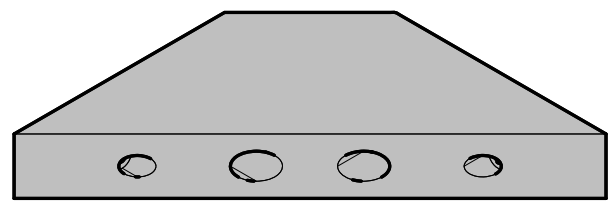

Q x2

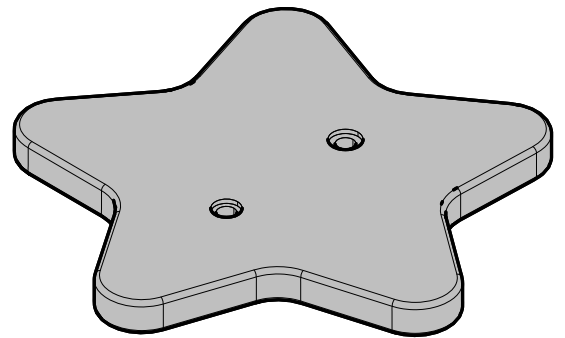

R x4

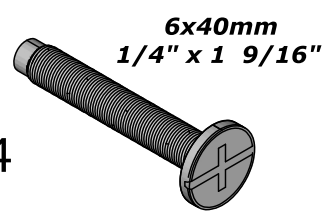

S x4



T x4



U x4

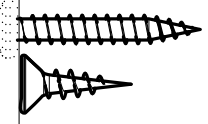
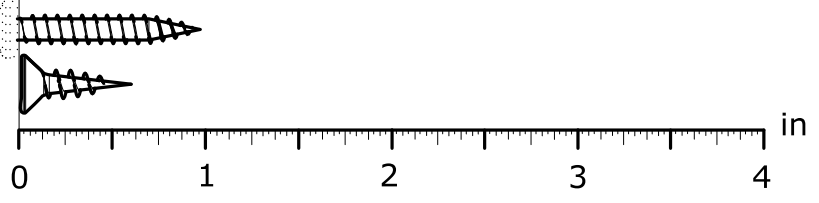
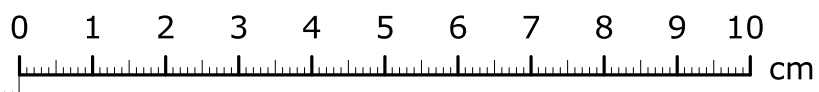
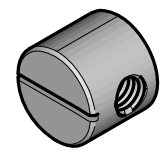

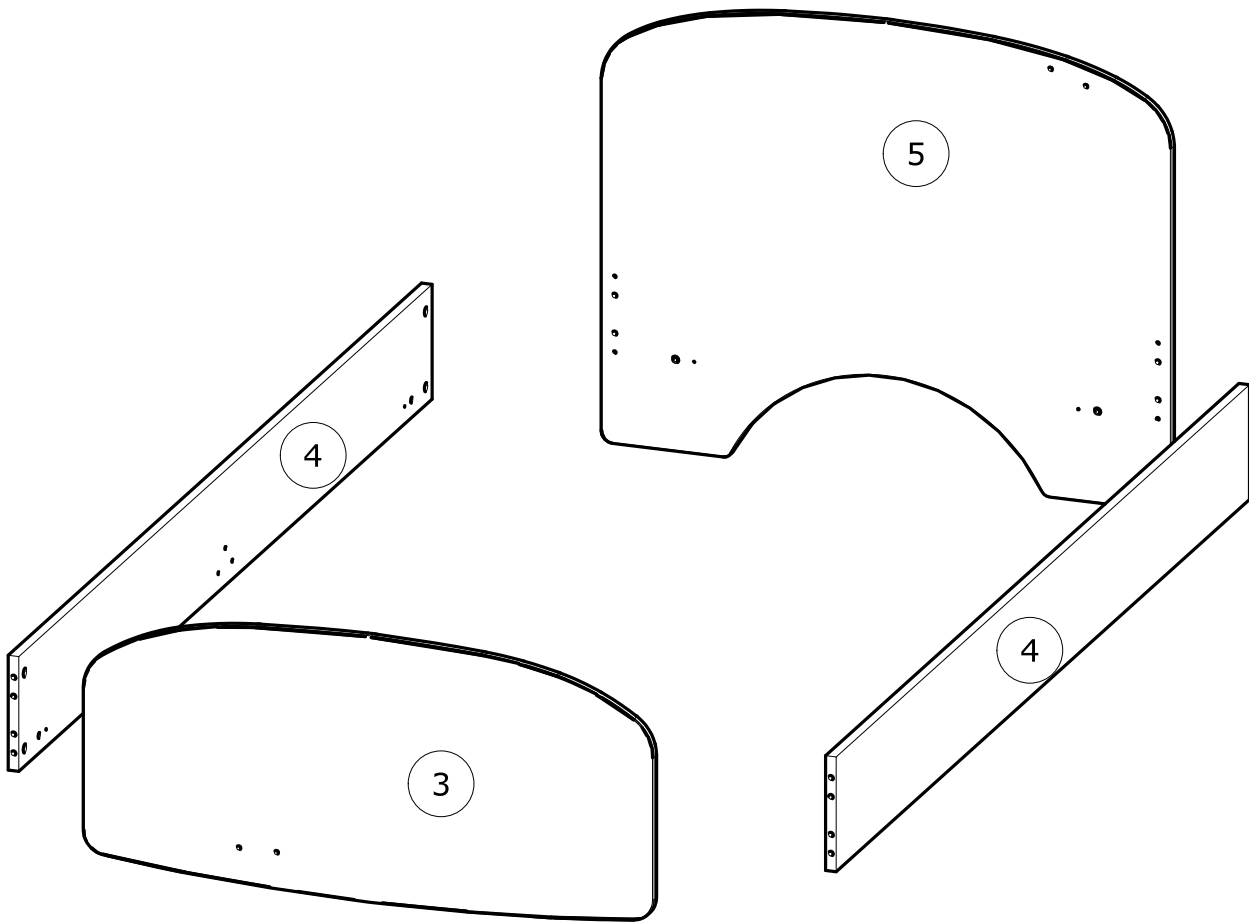

N°	MM			INCH			QTY
3	970	x	455	38 3/16	x	17 15/16	1
4	1 902	x	193	74 14/16	x	7 10/16	2
5	970	x	750	38 3/16	x	29 8/16	1

FR

NOTICE A CONSERVER.

EN COURS DE MONTAGE, PRENEZ GARDE AUX RISQUES DE PINCEMENT ET DE CISAILLEMENT.
NE PAS PLACER LE LIT A PROXIMITÉ D'UNE SOURCE DE CHALEUR.
NE PAS S'ASSEOIR A PLUSIEURS SUR LE LIT.
NE PAS SAUTER SUR LE LIT.
STOCKER LE LIT DANS UN ENDROIT SEC.

EN

DO NOT DISCARD THESE INSTRUCTIONS.

BEWARE OF PINCHING OR SHEARING HAZARDS DURING ASSEMBLY.
DO NOT PLACE THE BED CLOSE TO A HEAT SOURCE.
MULTIPLE PERSONS SHOULD NOT SIT ON THE BED AT THE SAME TIME.
DO NOT JUMP ON THE BED.
STORE THE BED IN A DRY PLACE.

DE

ANWEISUNG AUFBEWAHREN.

BEI DER MONTAGE SICH VOR QUETSCHRISIKEN HÜTEN.
DAS BETT NICHT IN DER NÄHE EINER WÄRMEQUELLE AUFSTELLEN.
NICHT ZUM SITZEN VON MEHREREN PERSONEN GEEIGNET.
NICHT AUF DEM BETT HÜPFEN.
DAS BETT AN EINER TROCKENEN STELLE LAGERN.

ES

CONSERVAR ESTAS INSTRUCCIONES.

DURANTE EL MONTAJE, TENER CUIDADO CON LOS RIESGOS DE APLASTAMIENTO Y DE CORTE.
NO COLOCAR LA CAMA CERCA DE UNA FUENTE DE CALOR.
NO SENTARSE VARIAS PERSONAS EN LA CAMA.
NO SALTAR EN LA CAMA.
ALMACENAR LA CAMA EN UN LUGAR SECO.

NL

GEBRUIKSAANWIJZINGEN TE BEWAAREN.

LET TIJDENS DE MONTAGE OP HET RISICO VAN KNIJP- EN AFSCHUIFWONDEN.
PLAATS HET BED NIET VLAKBIJ EEN WARMTEBRON.
GA NIET MET MEER PERSONEN OP HET BED ZITTEN.
SPRING NIET OP HET BED.
BEWAAR HET BED OP EEN DROGE PLAATS.

IT

CONSERVARE QUESTE ISTRUZIONI.

FARE ATTENZIONE AI RISCHI DI PIZZICAMENTO E TAGLIO DURANTE IL MONTAGGIO.
NON POSIZIONARE IL LETTO VICINO AD UNA FONTE DI CALORE.
NON SEDERSI IN PIÙ PERSONE SUL LETTO.
NON SALTARE SUL LETTO.
RIPORRE IL LETTO IN UN LUOGO ASCIUTTO.

PT

MANUAL A CONSERVAR.

EM MONTAGEM, TER CUIDADO COM AS BELISCADURAS E OS CORTES.
NÃO COLOCAR A CAMA EM PROXIMIDADE DE UMA FONTE DE CALOR.
NÃO SE SENTAR MUITAS PESSOAS NA CAMA.
NÃO SALTAR EM CIMA DA CAMA.
GUARDAR A CAMA NUM LUGAR SECO.

PL

INSTRUKCJA DO ZACHOWANIA

PODCZAS MONTAŻU UWAGAĆ NA RYZYKO ZACIŚNIĘCIA I PRZECIĘCIA.
NIE UMIESZCZAĆ ŁÓŻKA W POBLIŻU ŹRÓDEŁ CIEPŁA :
NIE SIADAĆ NA ŁÓŻKU W KILKA OSÓB.
NIE SKAKAĆ NA ŁÓŻKU.
ŁÓŻKO PRZECHOWYWAĆ W MIEJSCU SUCHYM.

CR

SAČUVAJTE UPUTE.

TIJEKOM POSTAVLJANJA PAZITE KAKO NE SE NE BISTE IZLOŽILI RIZIKU PRIKLJEŠTENJA ILI POREZIVANJA.
NE POSTAVLJAJTE KREVET U BLIZINI IZVORA TOPLINE.
VIŠE OSOBA NE SMIJE SJEDITI NA KREVETU.
NE SKAČITE PO KREVETU.
SPREMITE KREVET NA SUHO MJESTO

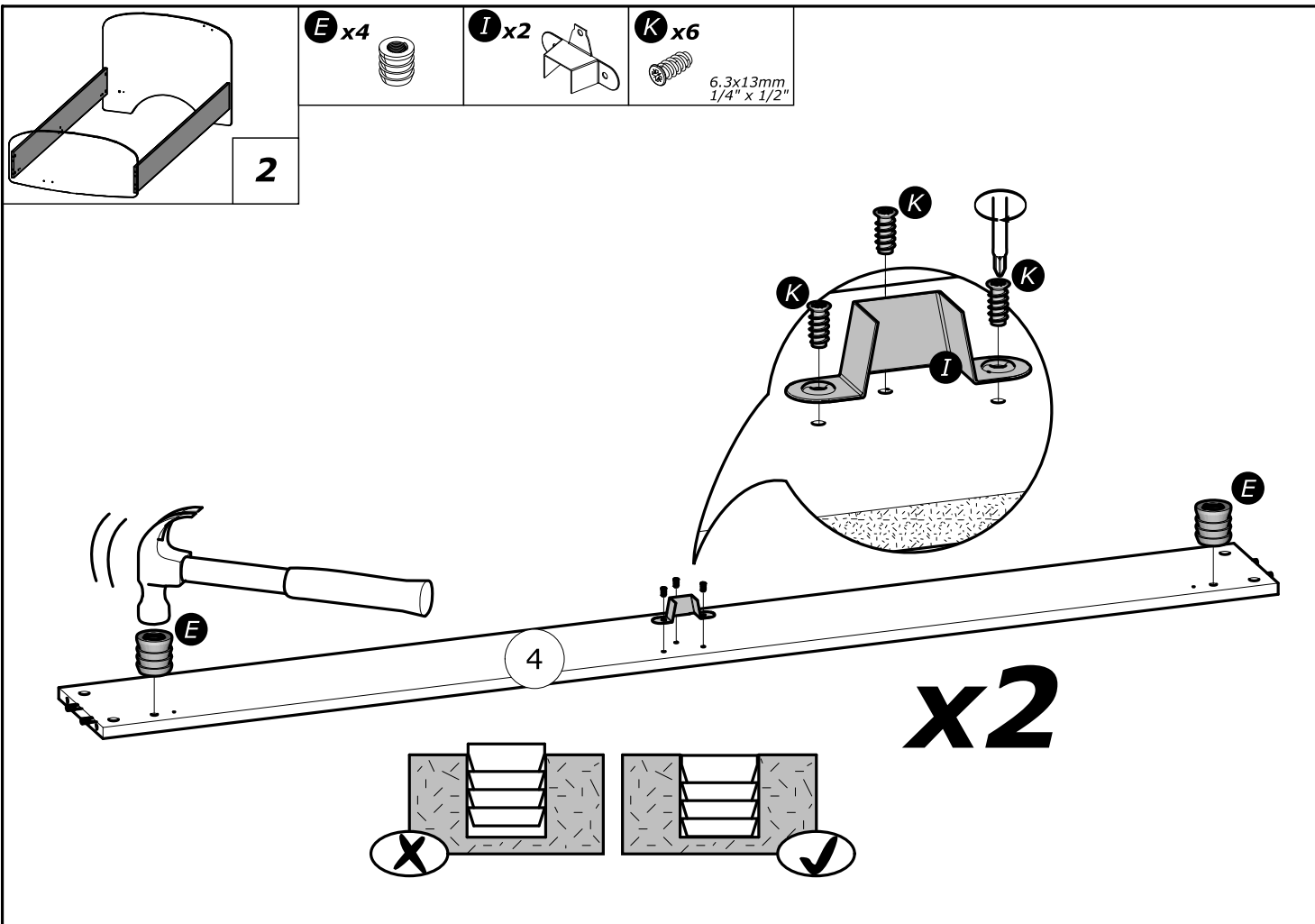
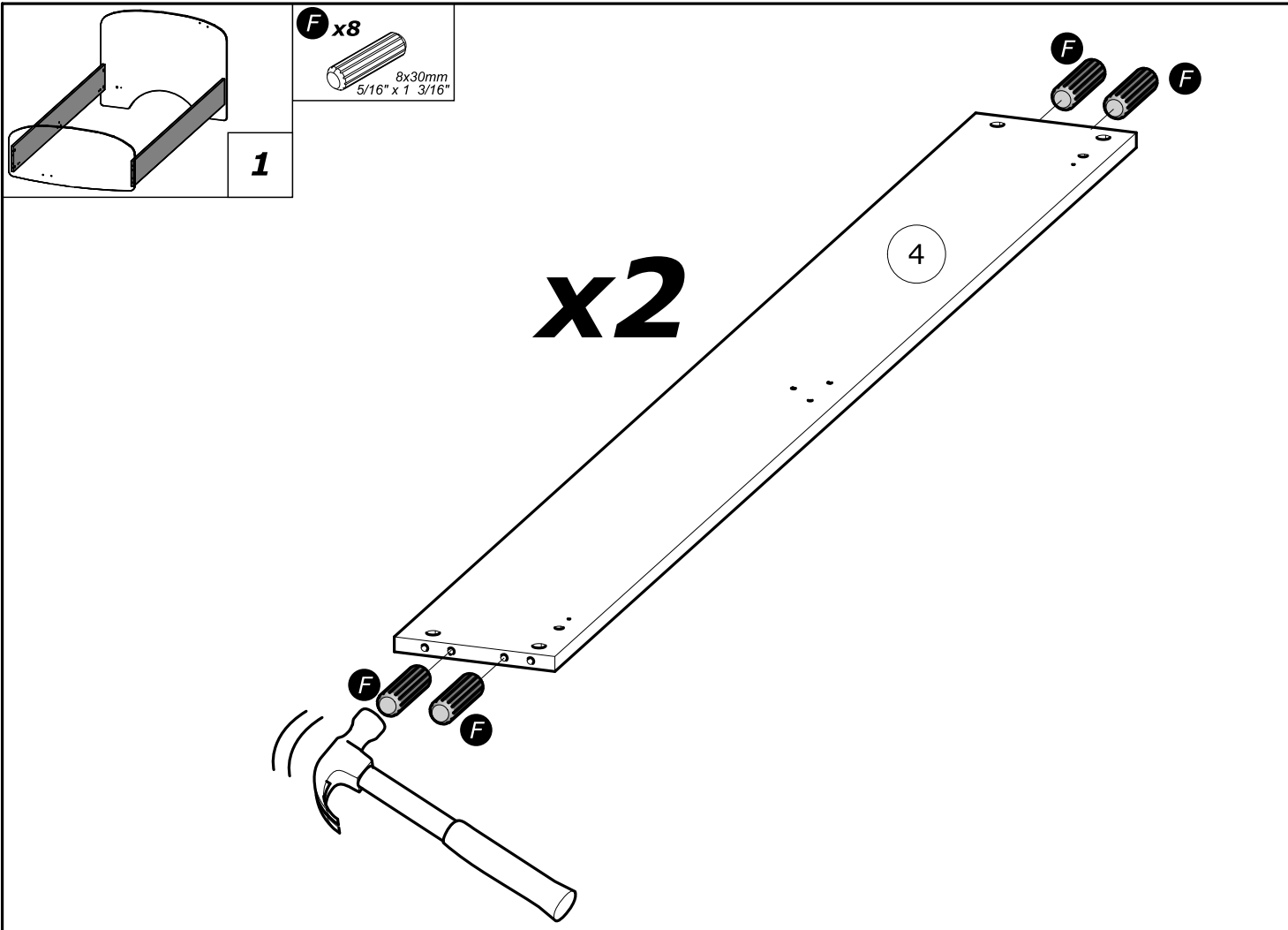

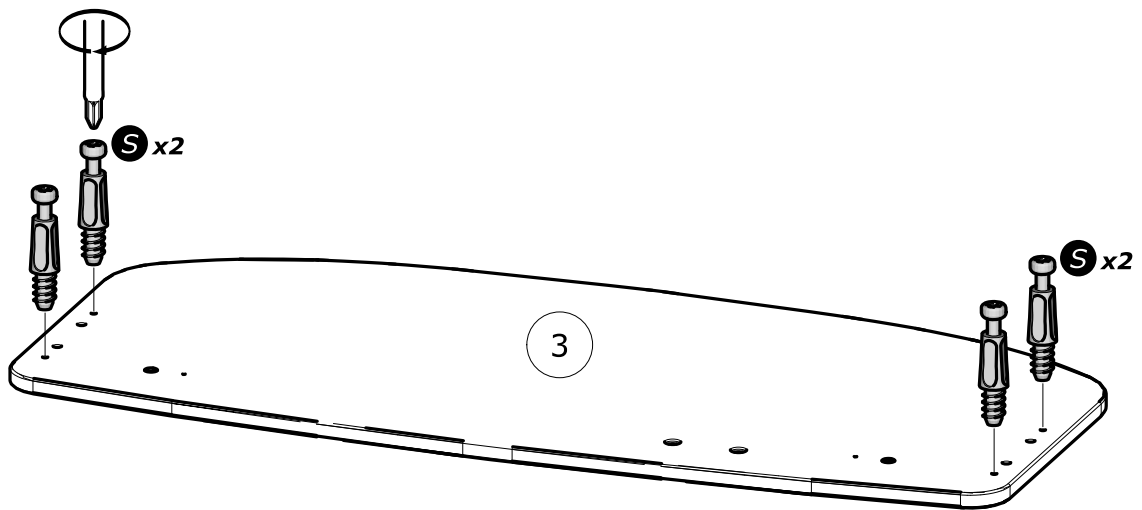
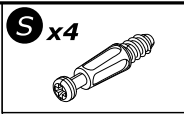
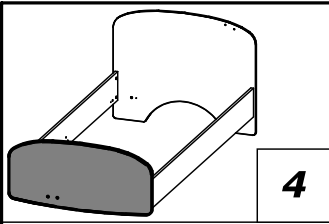
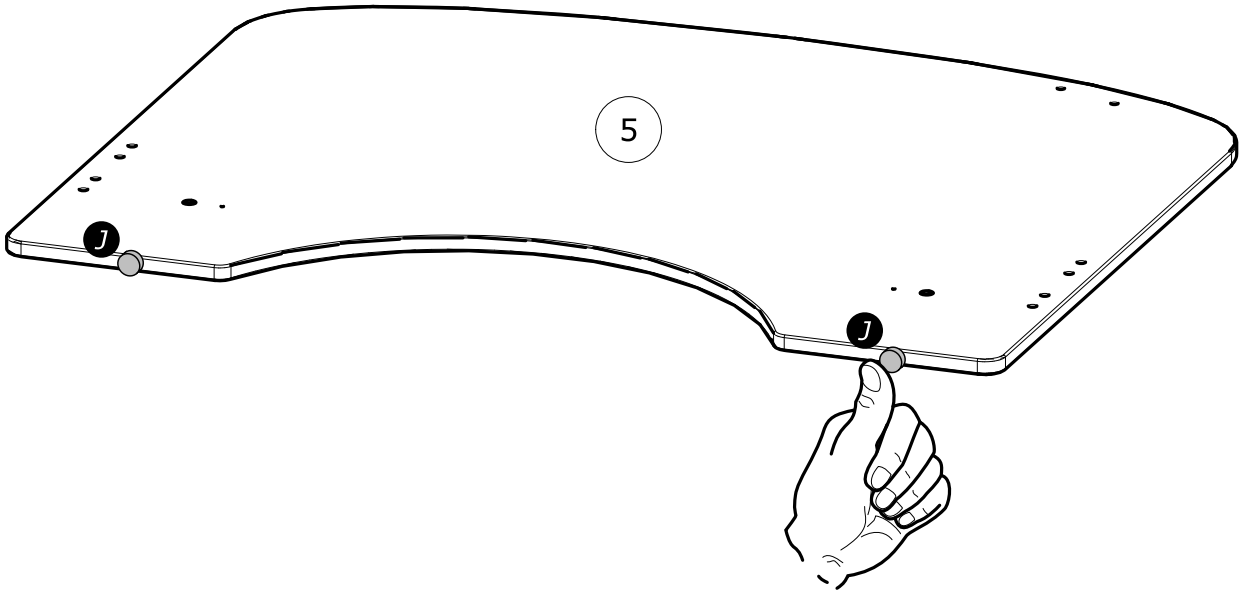
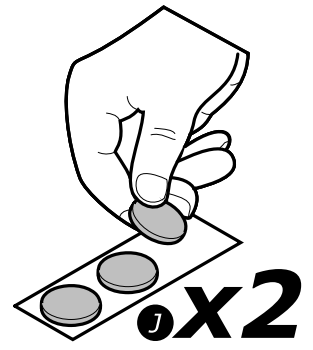
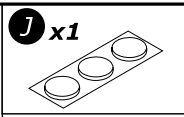
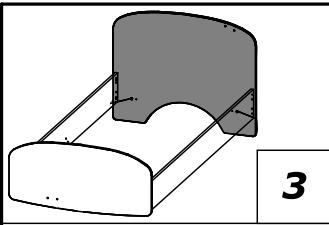

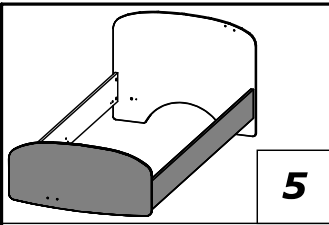

T x2
Ø15mm
Ø19/32"

5

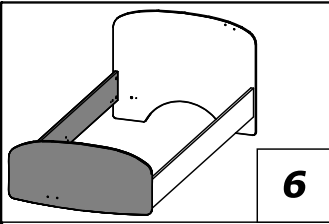
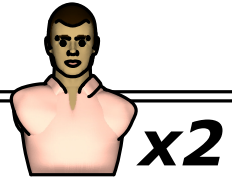
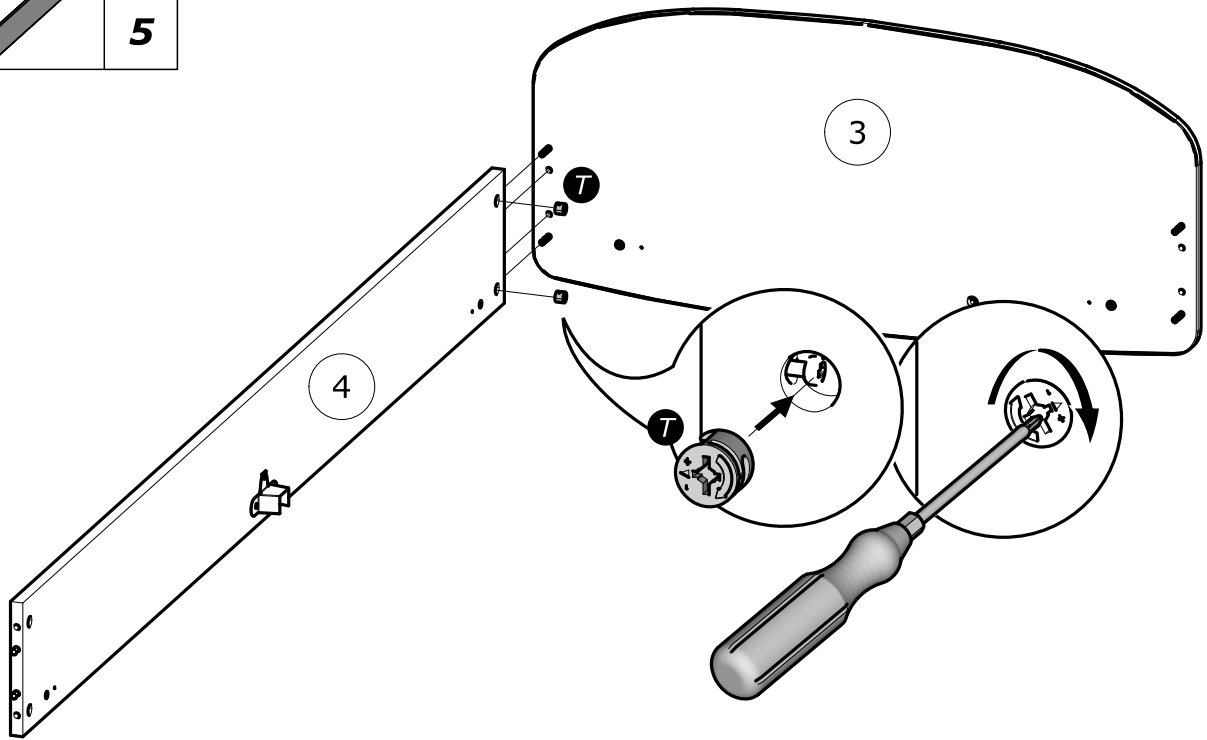

T x2
Ø15mm
Ø19/32"

6

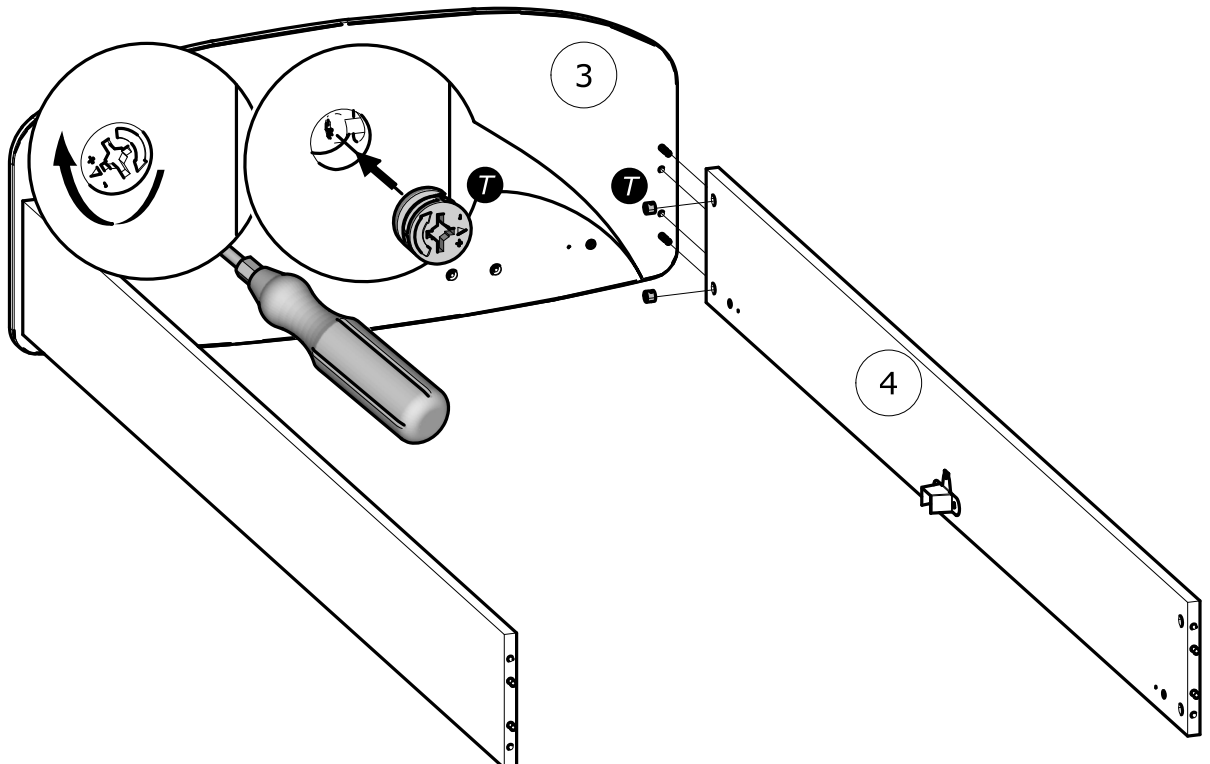

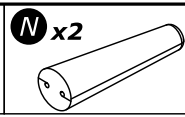
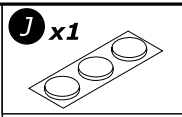
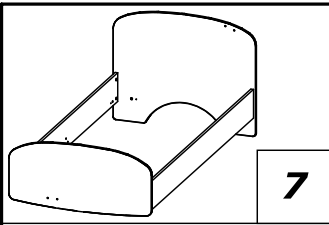

J x2

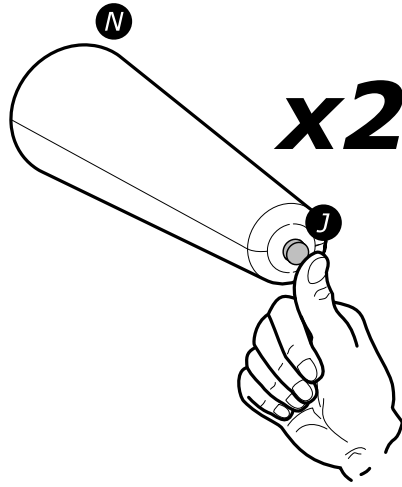

x2

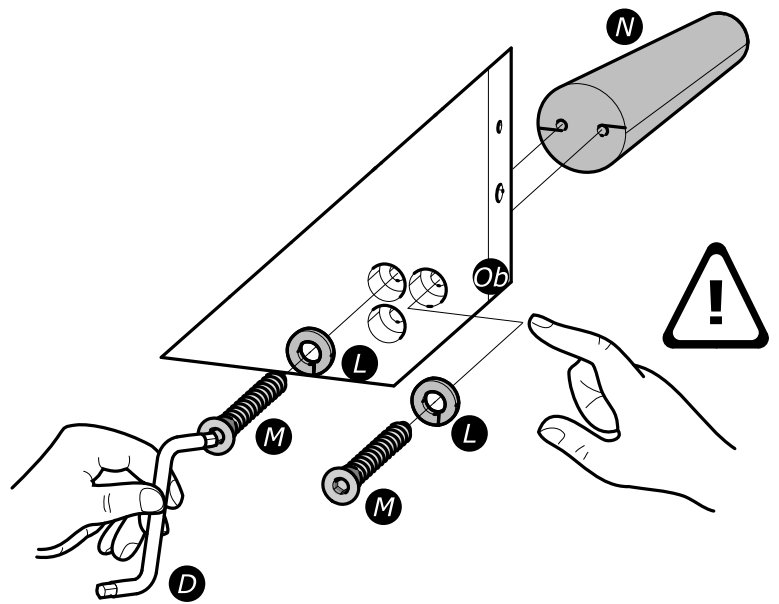
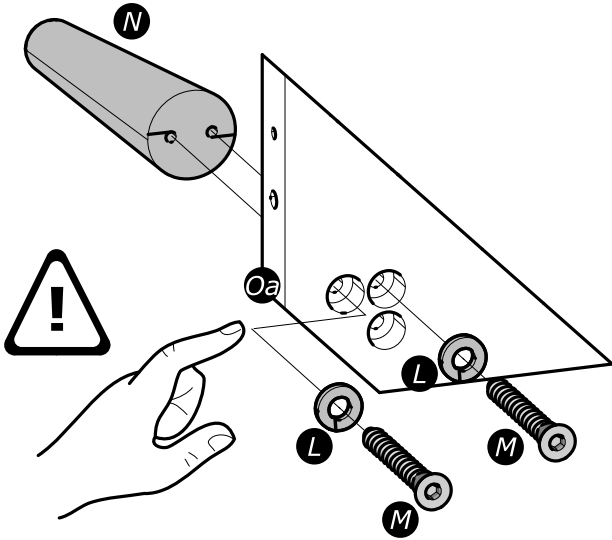
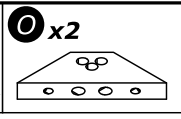
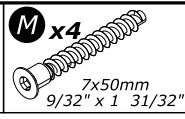
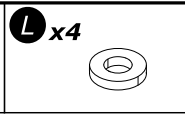
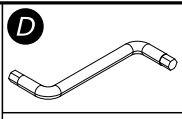
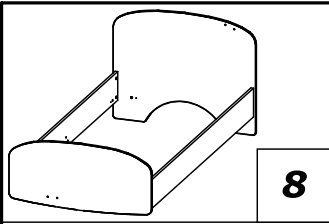

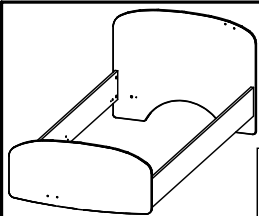

9

C x4
6x50mm
1/4" x 1 31/32"

G x4
4x35mm
5/32" x 1 3/8"

1°

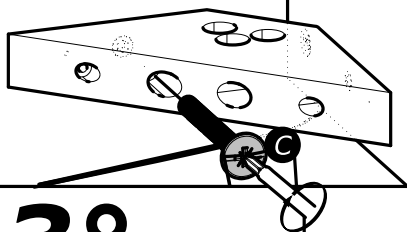

2°

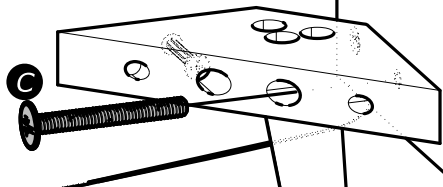

3°

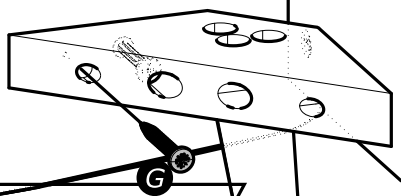

4°

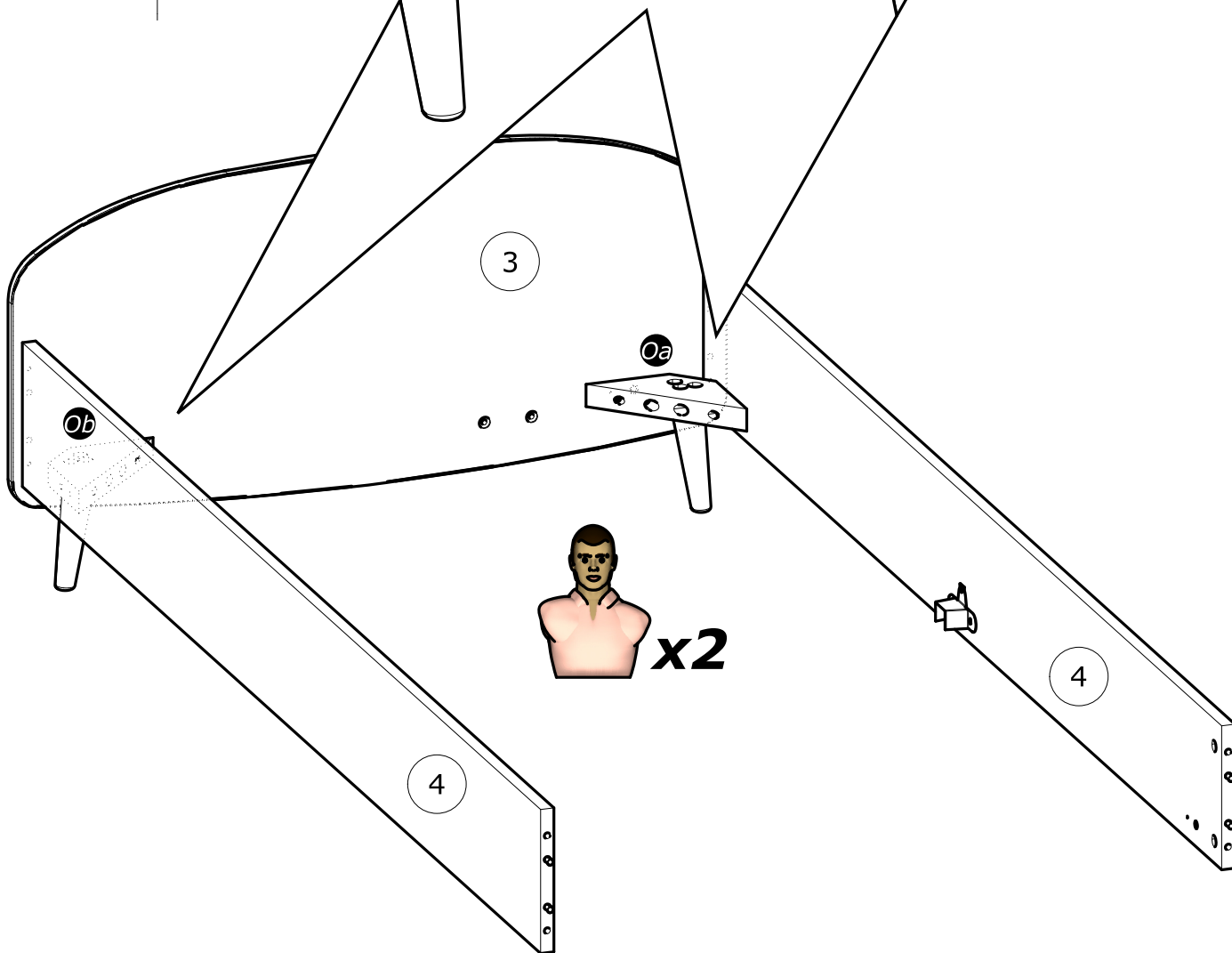
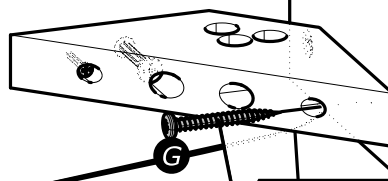

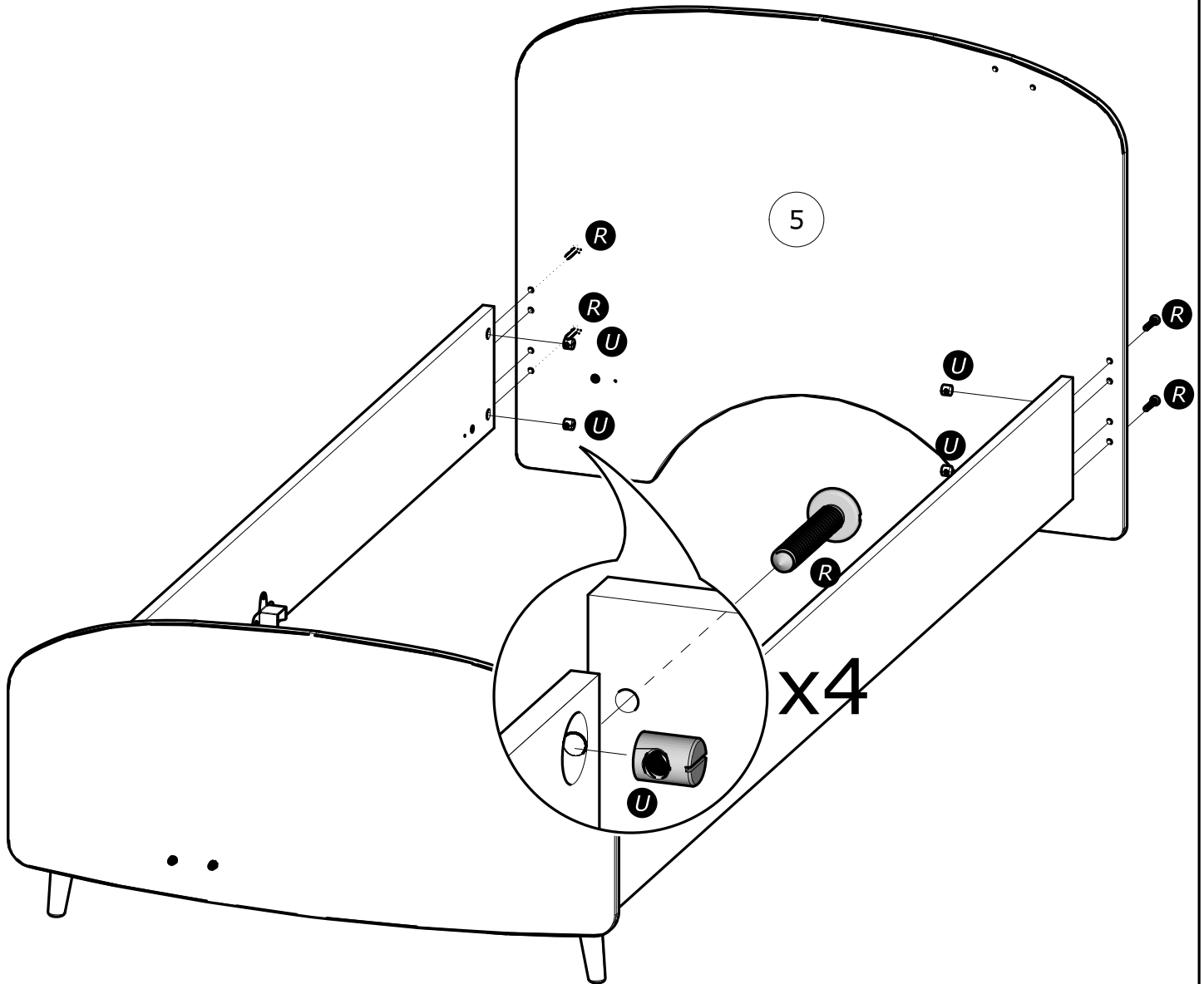
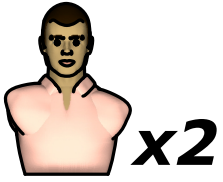
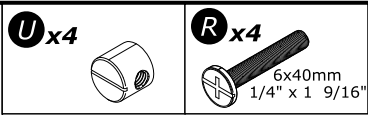
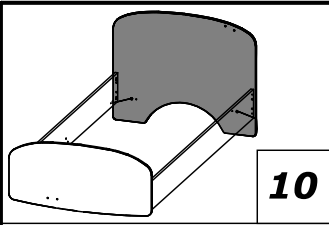

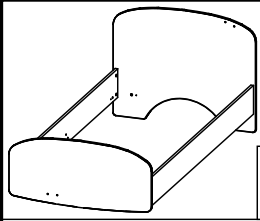

11

C x4
6x50mm
1/4" x 1 31/32"

G x4
4x35mm
5/32" x 1 3/8"

P x2

