

Zandiera

Ref: DAISY BUFFET 3 PORTES / 2 TIROIRS
Code EAN: 3 760 176 247 032

Descriptif technique:

En panneaux de particules épaisseur 16mm.
Mouliures / Pieds MDF. Décor imitation Chêne blanchi. Meuble à monter

Version du 23/06/20

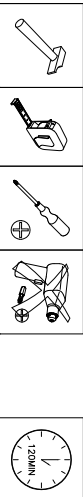

AVERTISSEMENT DE SECURITE

1. Prendre le temps de lire en entier et de suivre les étapes de la notice de montage
2. Ne pas jeter l'emballage sans vous être assuré d'avoir toutes les pièces disponibles pour le montage.
3. Assembler les éléments sur une surface lisse et propre pour éviter de les abîmer.
4. Tenir toutes les quincailleries hors de portée des enfants.
5. Prendre garde aux risques d'incendie qui peuvent entraîner une flammes vive

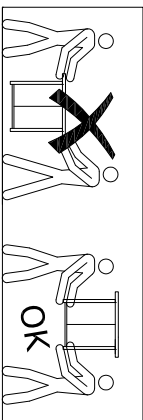
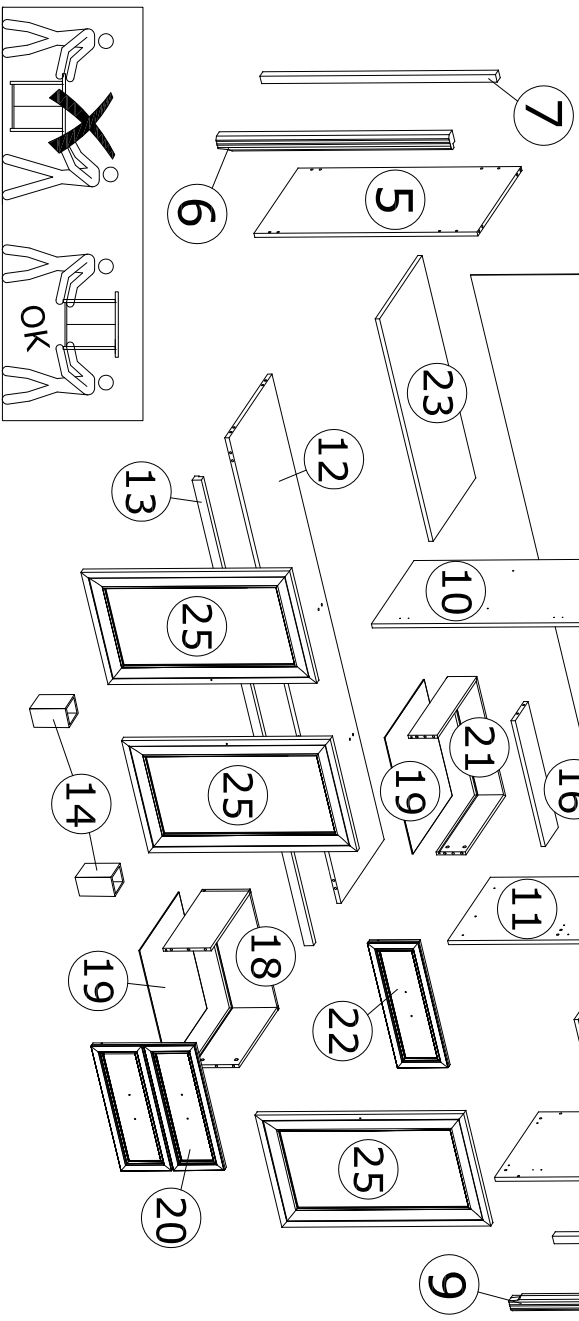

Colis 1/3	Colis 2/3	Colis 3/3
205 53 5cm	94 54 11cm	83 45 7cm
28 Kg 54 dm ³	29 Kg 56 dm ³	10 Kg 26 dm ³

65 Kg
Poids net

MEUBLE A USAGE DOMESTIQUE.
Nettoyage courant: chiffon doux sec ou humidifié à l'eau tiède



Montage nécessitant
2 personnes

NOTICE DE MONTAGE
ASSEMBLING INSTRUCTIONS
ISTRUZIONI DI MONTAGGIO
MONTAGEANLEITUNG
ISTRUCOES DE MONTAGEM
MANUAL DE MONTAJE
UPUTE ZA MONTAZU

FABRICATION
FRANÇAISE

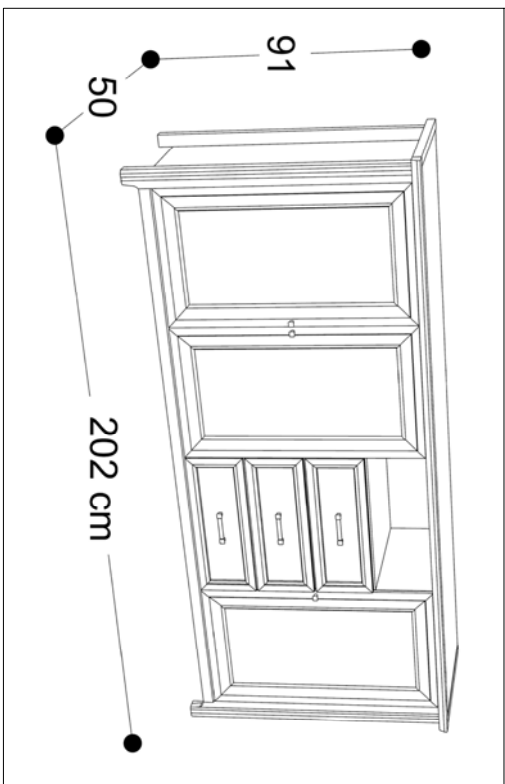

N°	Ref	Norm	Longueur	Largeur	Ep	Qté
1	6029 DE	Dessus	1957	458	16	1
2	6501 MG	Mouliure gauche	458	30	27	1
3	6502 MD	Mouliure droite	458	30	27	1
4	6511 BC	Bec de corbin	2013	40	28	1
5	6020 CG	côté gauche	840	445	16	1
6	6504 PG	Pieds gauche AV	877	60	40	1
7	6506 PA	Pieds Arrière	887	30	30	2
8	6021 CD	côté droit	840	445	16	1
9	6505 PD	Pieds droit AV	877	60	40	1
10	6026 SG	Séparation gauche	808	432	16	1
11	6027 SD	Séparation droite	808	432	16	1
12	6028 CB	Chassis bas	1865	434	16	1
13	6512 MB	Mouliure Basse	1865	35	28	1
14	0661 U	Pieds central	66	40	40	2
15	6087 TA	Tablette niche	504	431	16	1
16	6007 RE	Raidisseur	504	90	16	1
17	6032 DS	Dos meuble	1896	822 / 2	3	1
18	KT479B	Kit folding	479	400	180	1
19	6009 DS	Dos tiroir	466	397	3	2
20	6033 FD	Facade tiroir double 500	500	389	22	1
21	KT4794	Kit folding	479	400	110	1
22	6005 FA	Facade tiroir 500	500	191	22	1
23	6030 RA	Rayon gauche	891	431	16	1
24	6019 RA	Rayon droit	438	431	16	1
25	6023 PO	Porte 450	786	450	22	3

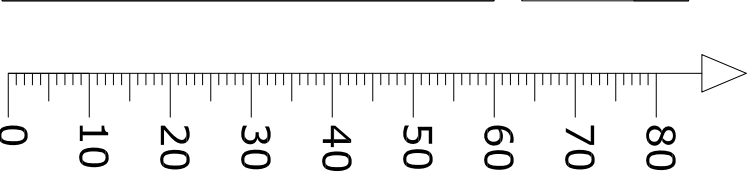
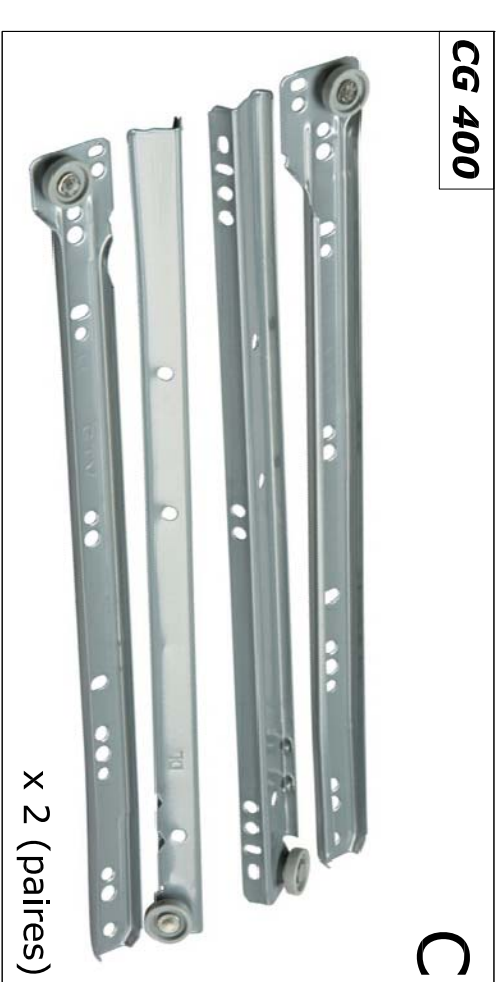
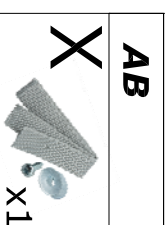
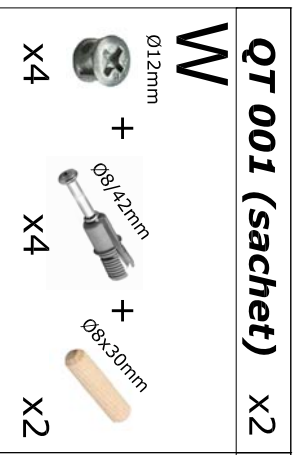
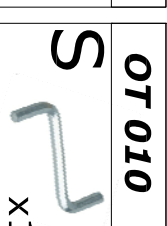
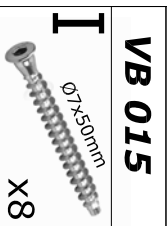
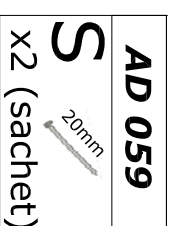
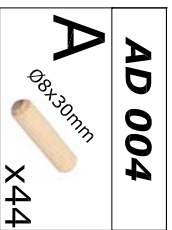

1/21

VX 034
M
Ø5/14mm
X4

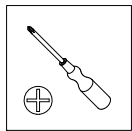
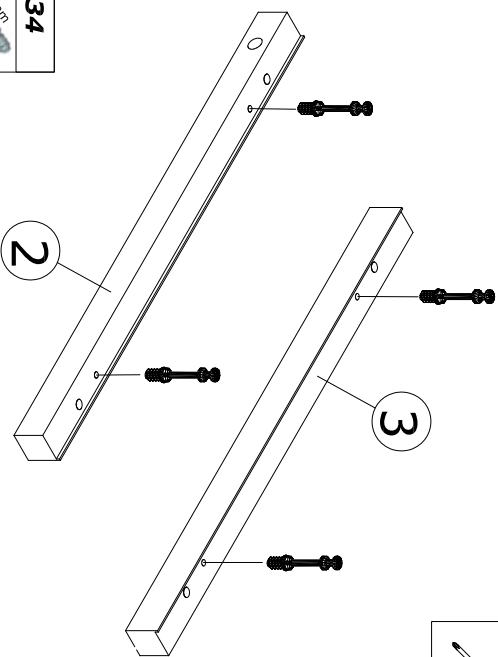

3/21

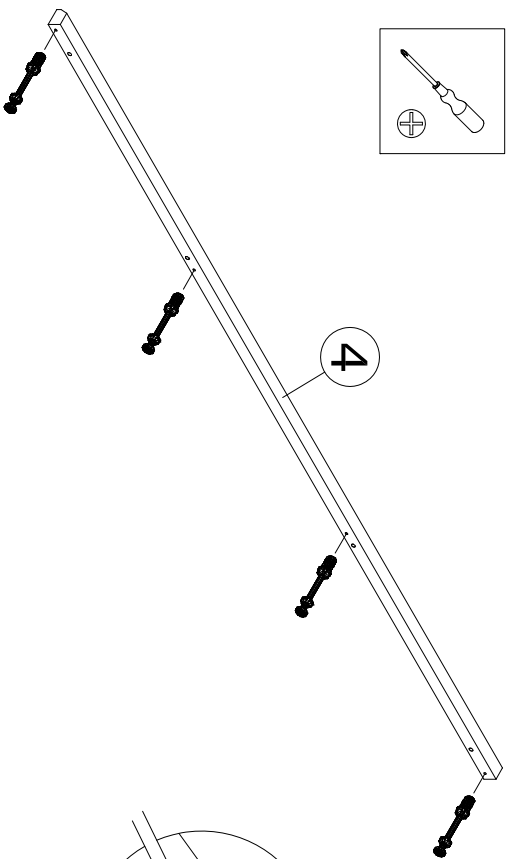
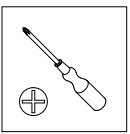

VX 034
M
Ø5/14mm
X4

2/21

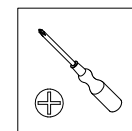
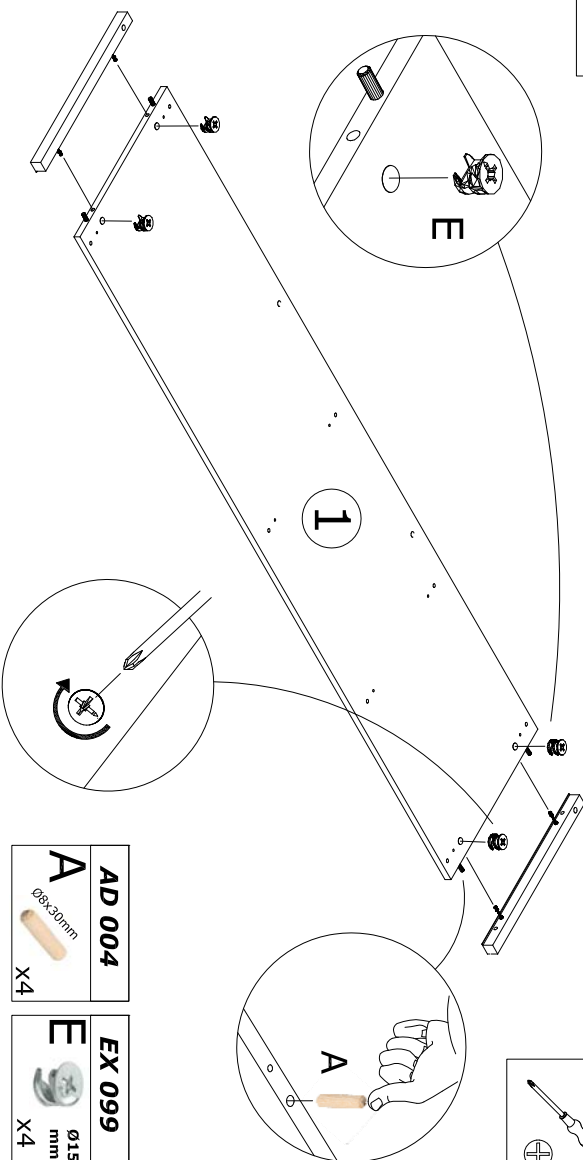

AD 004
A
Ø8x30mm
X4

EX 099
E
Ø15
mm
X4

4/21

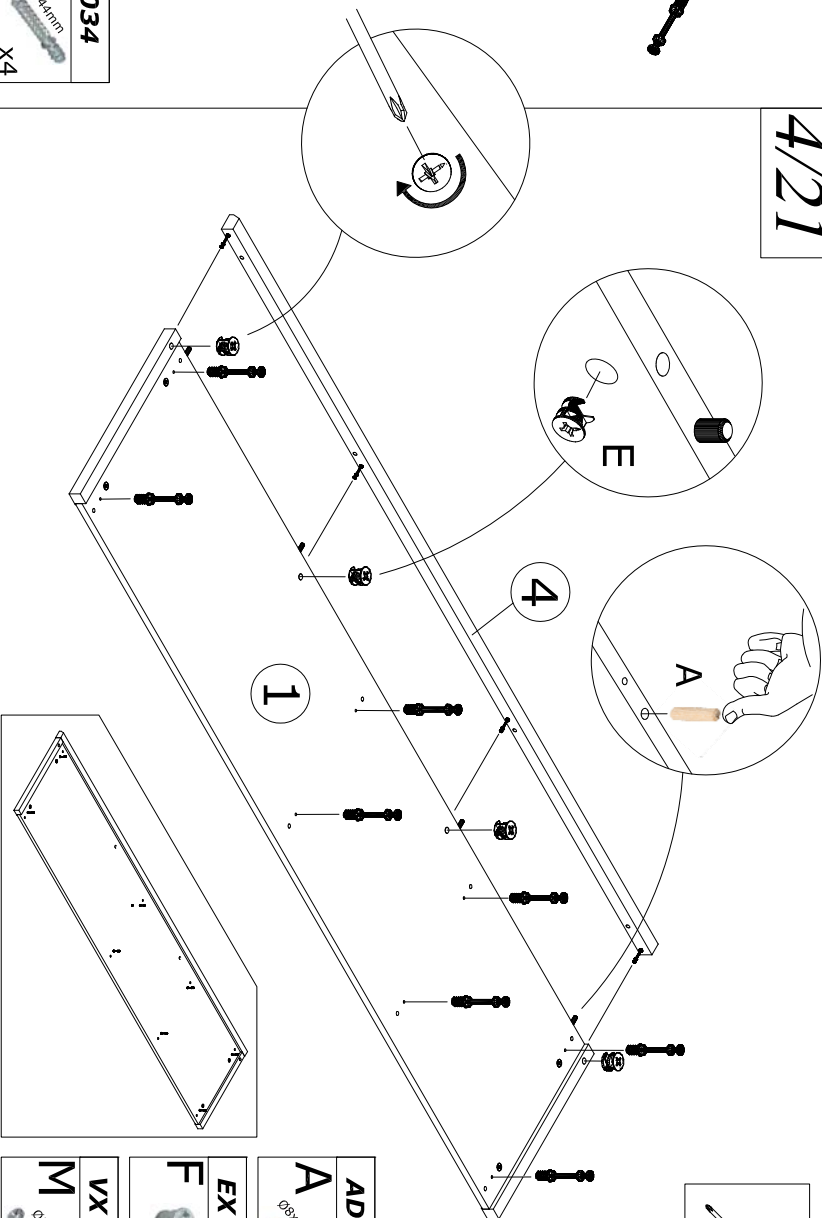
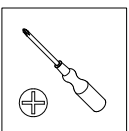

AD 004
A
Ø8x30mm
X4

EX 012
F
Ø12
mm
X4

VX 034
M
Ø5/14mm
X8

9/21

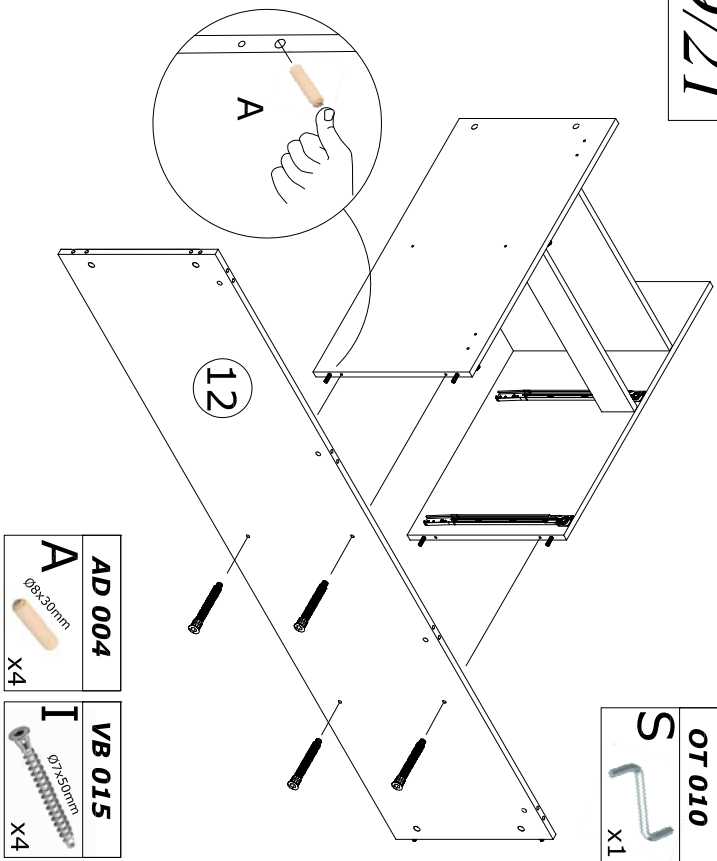

OT 010	S	X1
---------------	----------	----

AD 004	A	Ø8x30mm	X4
VB 015	I	Ø7x50mm	X4

10/21

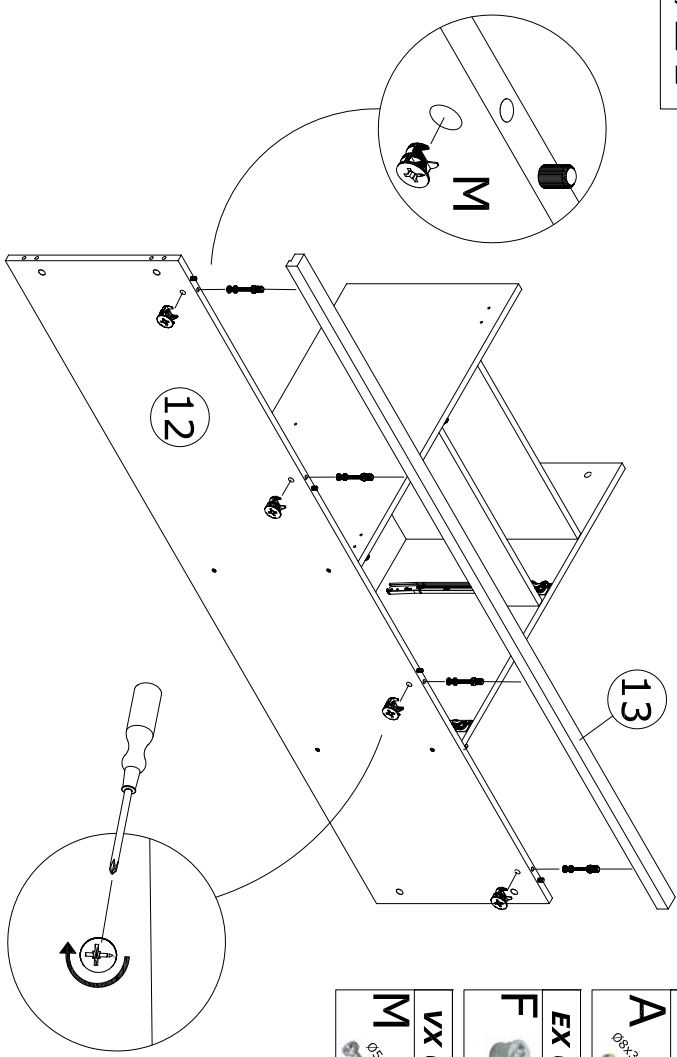

AD 004	A	Ø8x30mm	X4
EX 012	F	Ø12 mm	X4
VX 034	M	Ø5x4mm	X4

11/21

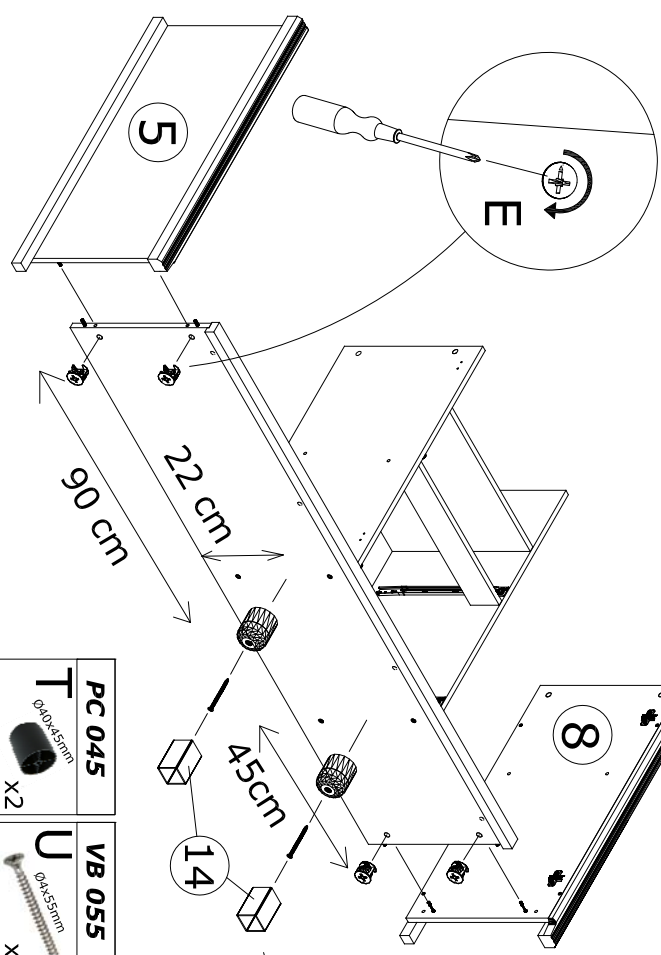

PC 045	T	Ø40x45mm	X2
VB 055	U	Ø4x55mm	X2
EX 099	E	Ø15 mm	X4
AD 004	A	Ø8x30mm	X4

12/21

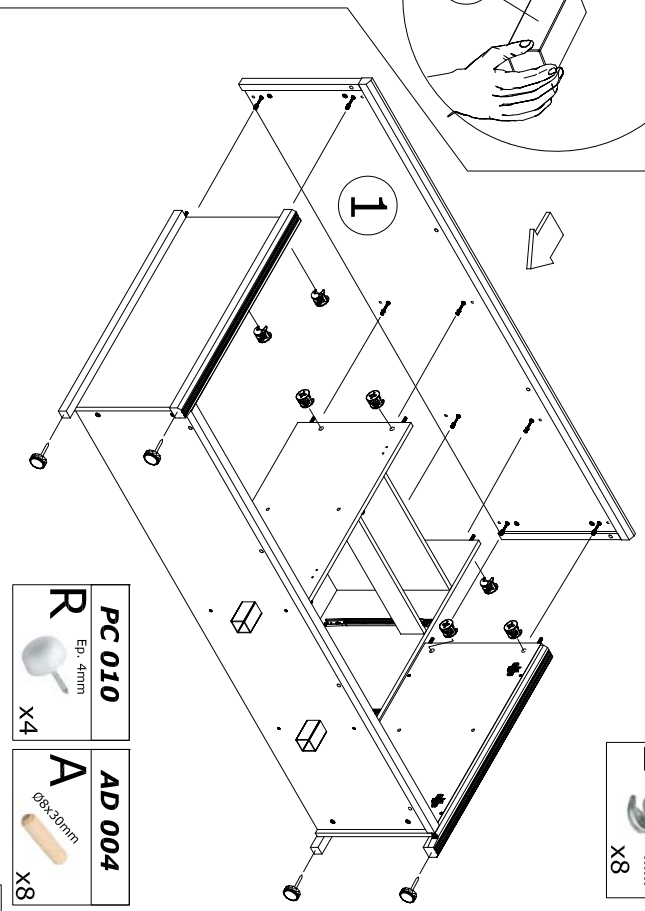

EX 099	E	Ø15 mm	X8
AD 004	A	Ø8x30mm	X8

13/21

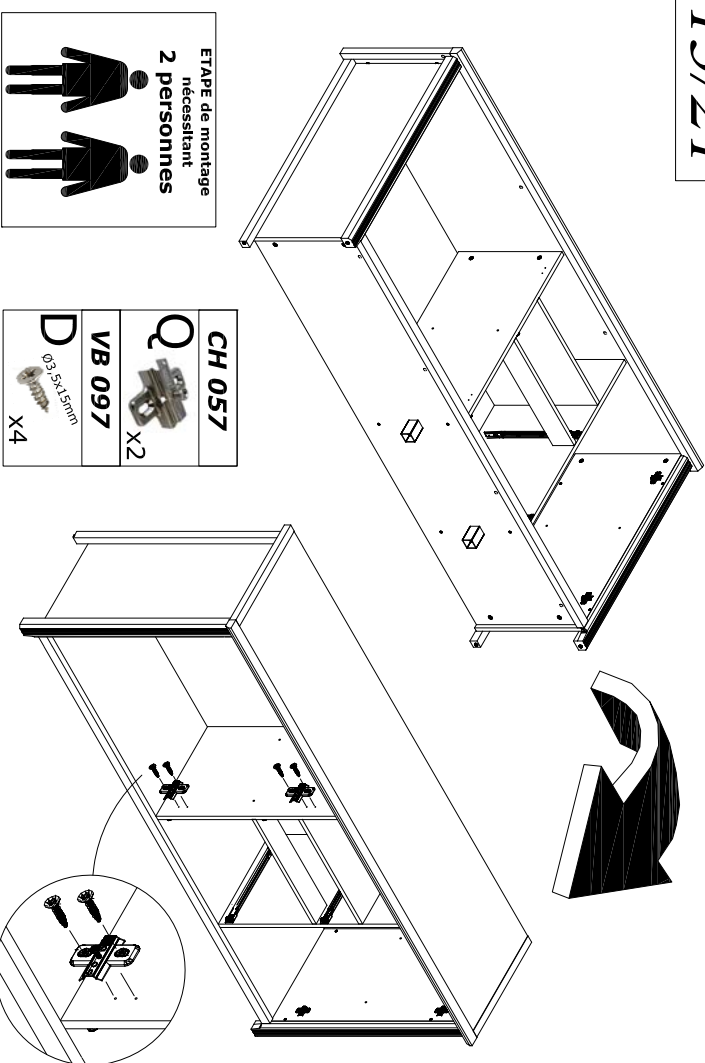

14/21

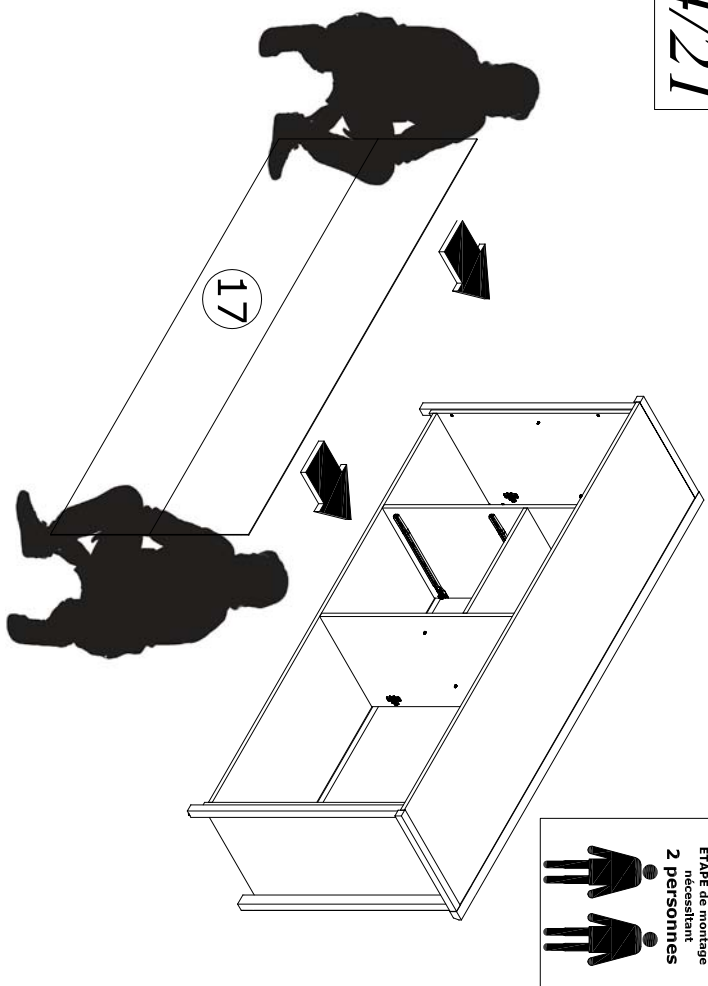

15/21

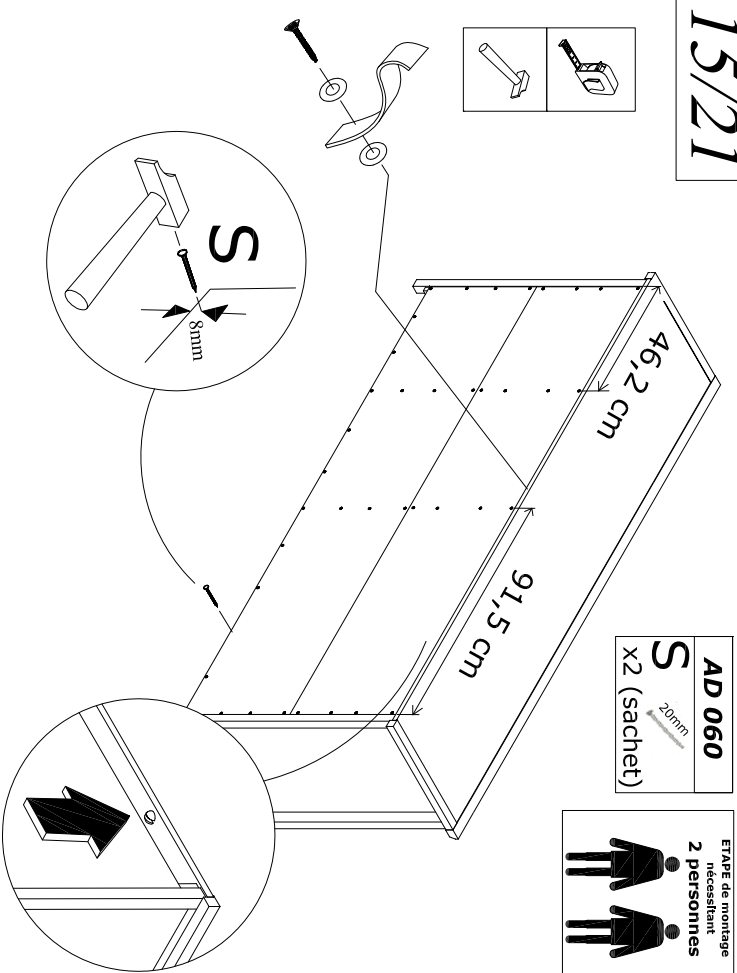

16/21

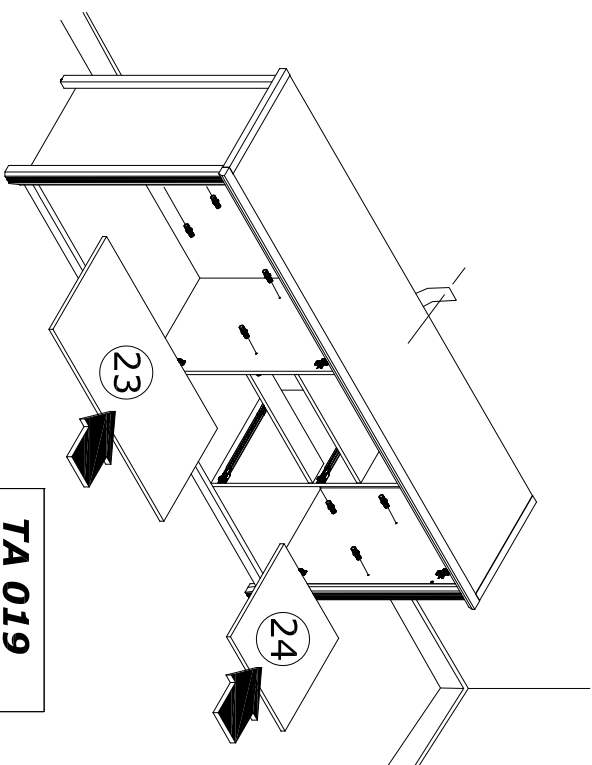
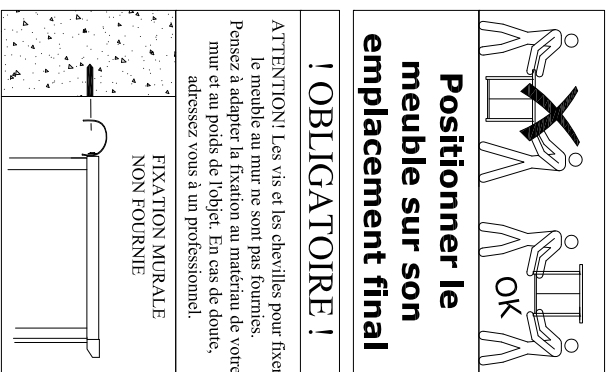

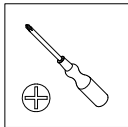

CH 087	Q4	VB 097
	Ø35mm / BRAS 17 mm AVEC amorti	Ø3,5x15mm x2

x1

CH 077	Q3	VB 097
	Ø35mm / BRAS 17 mm SANS amorti	Ø3,5x15mm x2

x1

CH 088	Q2	VB 097
	Ø35mm / BRAS 0 mm AVEC amorti	Ø3,5x15mm x2

x1

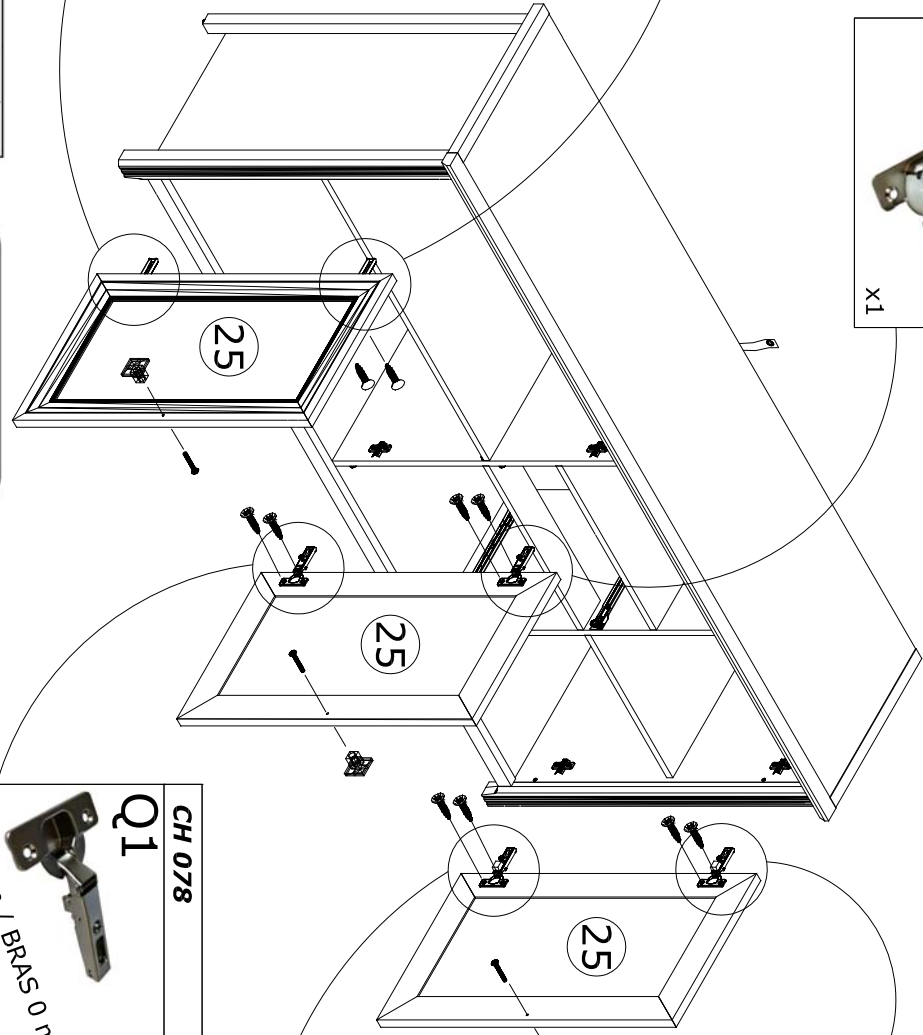
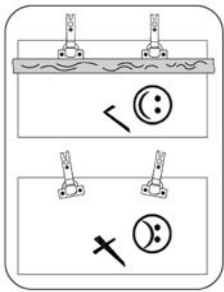
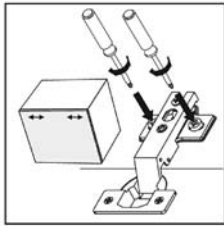
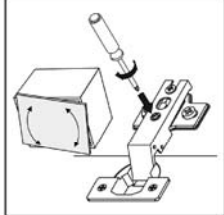
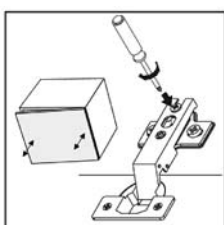

CH 087	Q4	VB 097
	Ø35mm / BRAS 17 mm AVEC amorti	Ø3,5x15mm x2

x1

PO 024	P2
	x3

VF 427	L
	Max 27mm x3

CH 078	Q1	VB 097
	Ø35mm / BRAS 0 mm SANS amorti	Ø3,5x15mm x2

x1

CH 077	Q3	VB 097
	Ø35mm / BRAS 17 mm SANS amorti	Ø3,5x15mm x2

x1

18/21

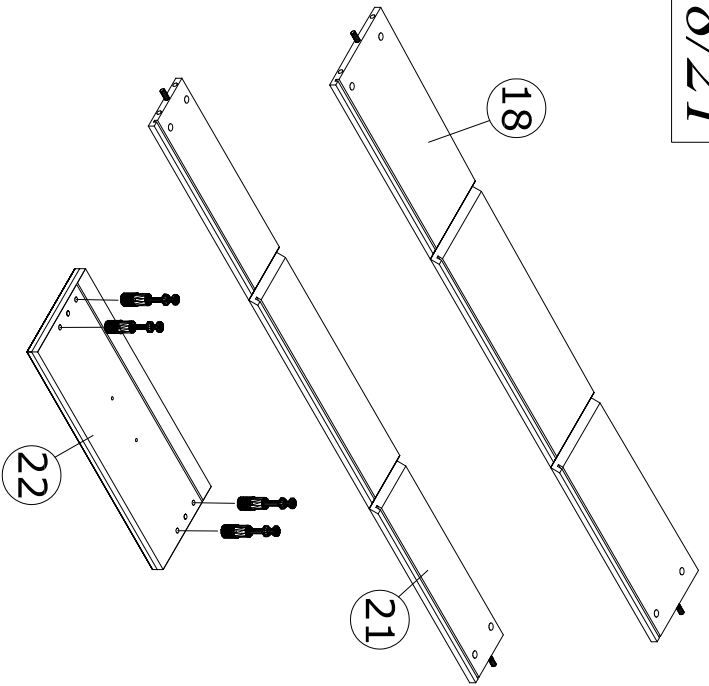

W	QT 001 (sachet) X2
012mm + 08x42mm + 08x30mm X4 X4 X2	

P1	PO 096
	Entraxe 96mm X3

K	VF 418
	Max: 3mm X6

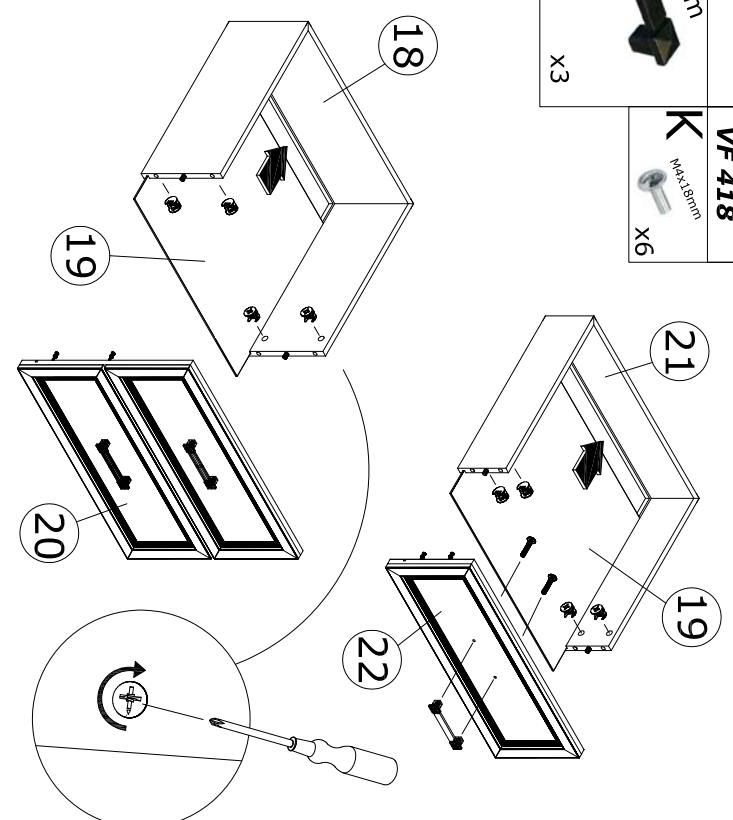
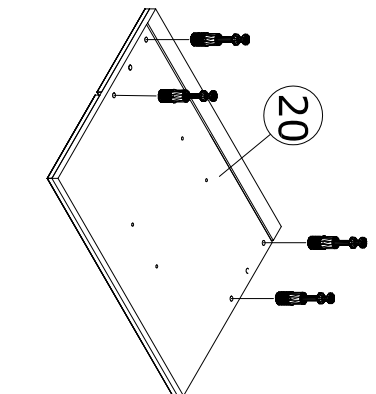

19/21

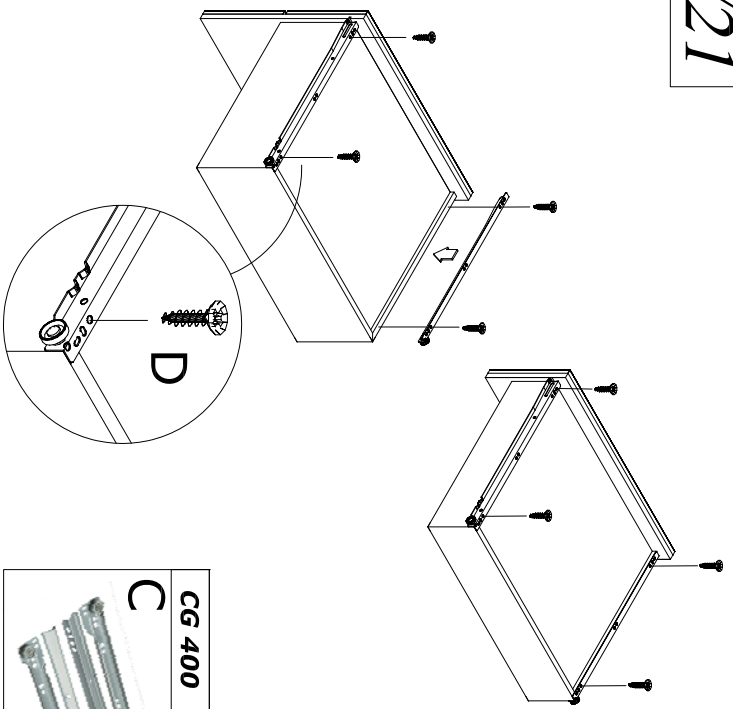

D	VB 097
	03.5x15mm X8
C	CG 400
	X2 (paires)

20/21

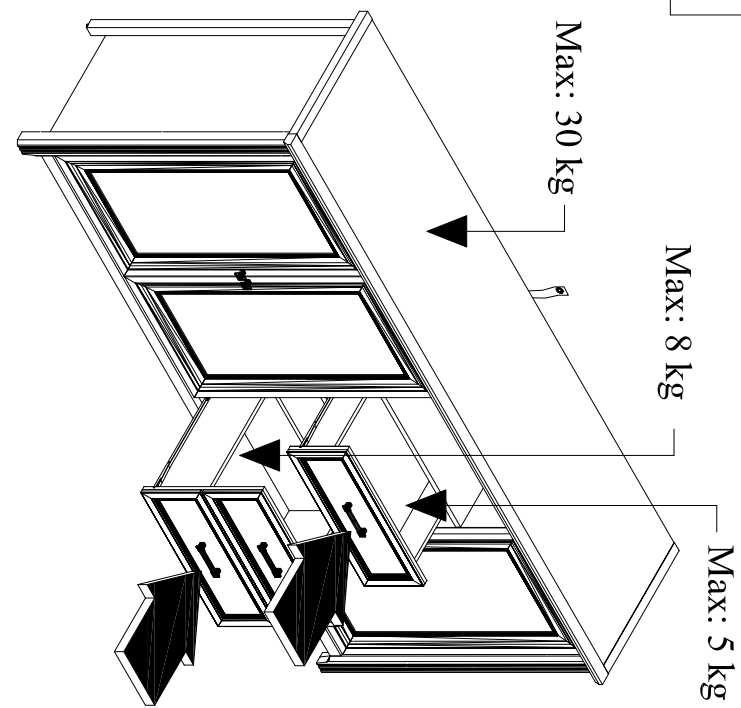

Max: 30 kg

Max: 8 kg

Max: 5 kg