

| | | |
|----------------|---------------|-----------------------|
| REFERENCE NO. | 4894223196246 | CHENE&NOIR/ OAK&BLACK |
| NOM DU PRODUIT | MEMO CONSOLE | |
| EAN: | 4894223196246 | CHENE&NOIR/ OAK&BLACK |

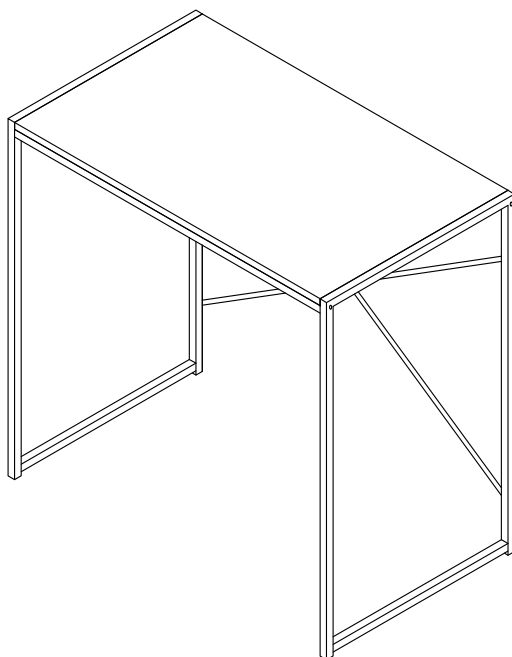

FAITES UN GESTE ECOCITOYEN
 EN TRIANT VOS EMBALLAGES CARTON

A LA FIN DE VIE DE VOTRE PRODUIT, VOUS
 POUVEZ LE DONNER À UNE STRUCTURE DE
 REEMPLOI SI IL EST EN BON ETAT, SINON LE
 DEPOSER À LA DECHETERIE PROCHÈ DE
 VOTRE DOMICILE



FR

1. Repérez les différentes pièces nécessaires à l'assemblage de votre meuble.
 2. Regroupez et comptez les pièces de quincaillerie.
 3. Munissez-vous de l'outillage nécessaire à l'assemblage de votre meuble.
 4. Aménagez-vous un espace propice à l'assemblage; moquette et couverture peuvent protéger votre meuble des rayures
 5. Procédez au montage sans forcer. Il est recommandé de resserrer les vis au fil de l'utilisation.
 6. Après l'assemblage de ce produit, il est conseillé d'aérer régulièrement la pièce pendant quelques jours.
- CONSERVEZ VOTRE NOTICE DE MONTAGE. SI UNE PIÈCE VENAIT À MANQUER, L'INFORMATION RELATIVE À CELLE-CI FOURNIE PAR LA NOTICE DE MONTAGE RESTE LE MOYEN LE PLUS EFFICACE DE COMMUNIQUER AVEC VOTRE MAGASIN.



EN

1. Identify the parts which make up your piece of furniture.
 2. Gather the hardware parts and count them.
 3. Have the necessary assembly tools ready.
 4. Organize a space for assembly, wall carpeting or a blanket will protect the furniture against scratches.
 5. Never force the assembling while you put the parts together. You are recommended to tighten the screws after the furniture has been used for some time.
 6. After assembling this product, it is advisable to regularly ventilate the room for a few days.
- KEEP THE ASSEMBLY INSTRUCTION. THE RELEVANT INFORMATION YOU CAN FIND ON IT WILL HELP YOU GET IN TOUCH WITH YOUR STORE IF A PART WAS TO BE MISSING.

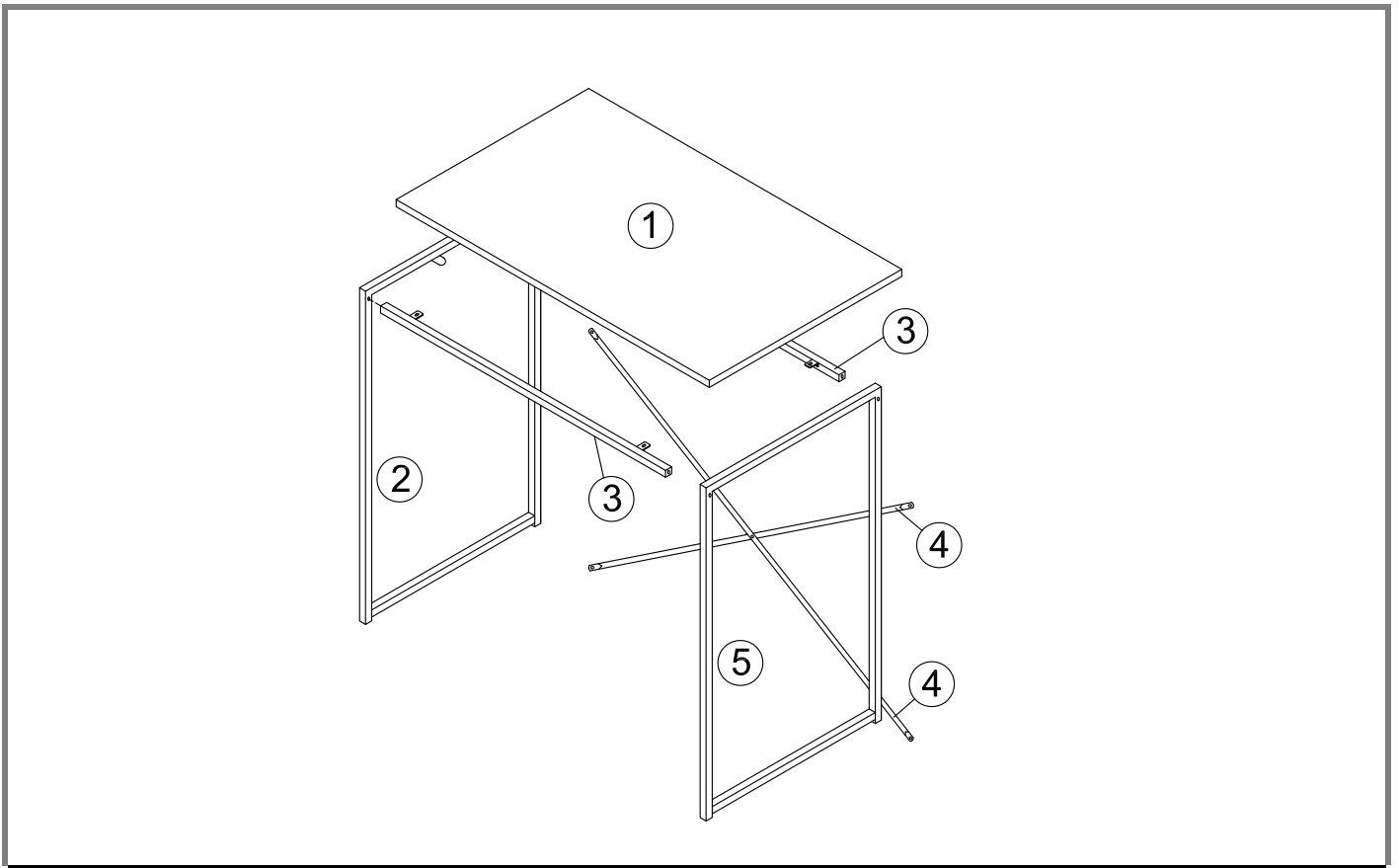



| No. | Taille | Qté | Ctn no. |
|-----|--------------|--------|---------|
| No. | Size | Qty | Ctn no. |
| No. | Tamaño | Cant | Ctn no. |
| Nr. | Maße | Anzahl | Ktn nr. |
| 1 | 747x399x15mm | 1 | 1 |
| 2 | 760x400x30mm | 1 | 1 |
| 3 | 16x36x748mm | 2 | 1 |

| No. | Taille | Qté | Ctn no. |
|-----|--------------|--------|---------|
| No. | Size | Qty | Ctn no. |
| No. | Tamaño | Cant | Ctn no. |
| Nr. | Maße | Anzahl | Ktn nr. |
| 4 | Ø10x887mm | 2 | 1 |
| 5 | 760x400x30mm | 1 | 1 |

| No. | Taille | Qté | Ctn no. |
|-----|--------|--------|---------|
| No. | Size | Qty | Ctn no. |
| No. | Tamaño | Cant | Ctn no. |
| Nr. | Maße | Anzahl | Ktn nr. |
| | | | |
| | | | |
| | | | |

Quincailleries/Hardware/Herrajes/ Montageteile- Ctn no./Kto. nr. 1

| | |
|---|----|
| 108 | x8 |
|  | |
| M6x12mm | |

| | |
|---|----|
| 126 | x4 |
|  | |
| M6x35mm | |

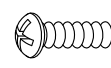

| | |
|---|----|
| 174 | x1 |
|  | |
| M4x20mm | |

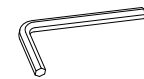
| | |
|---|----|
| 135 | x1 |
|  | |
| M4 | |

| | |
|---|----|
| 112 | x1 |
|  | |
| 4mm | |

| | |
|---|----|
| 171 | x1 |
|  | |
| M4 | |

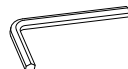
 **TEMPS DE MONTAGE: 20 MINUTE**
SET-UP TIME: 20 MINUTE



 **OUTILLAGE:**
TOOLS:   

 **NOMBRE DE PERSONNES: 02**
NUMBER OF PERSONS: 02

 **POUR L' ENTRETIEN, UN CHIFFON DOUX SUFFIRA.**
A SOFT CLOTH IS SUITABLE FOR PRODUCT CARE.

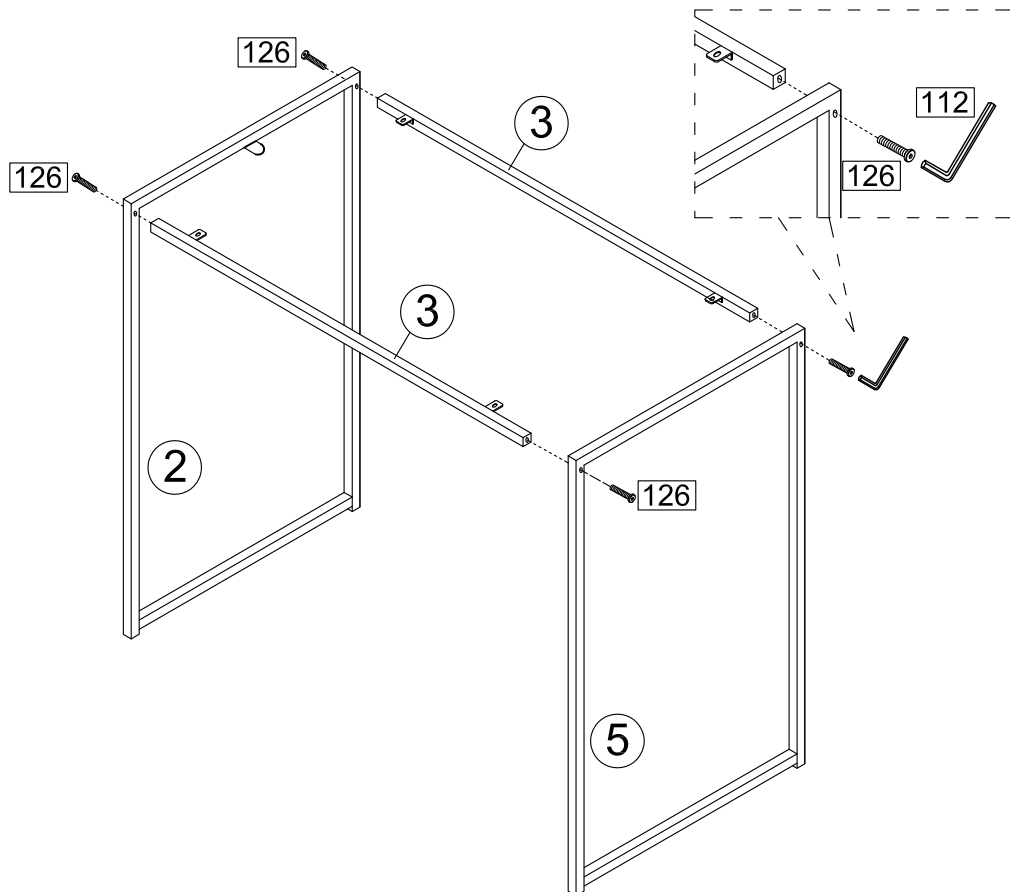

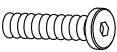
1



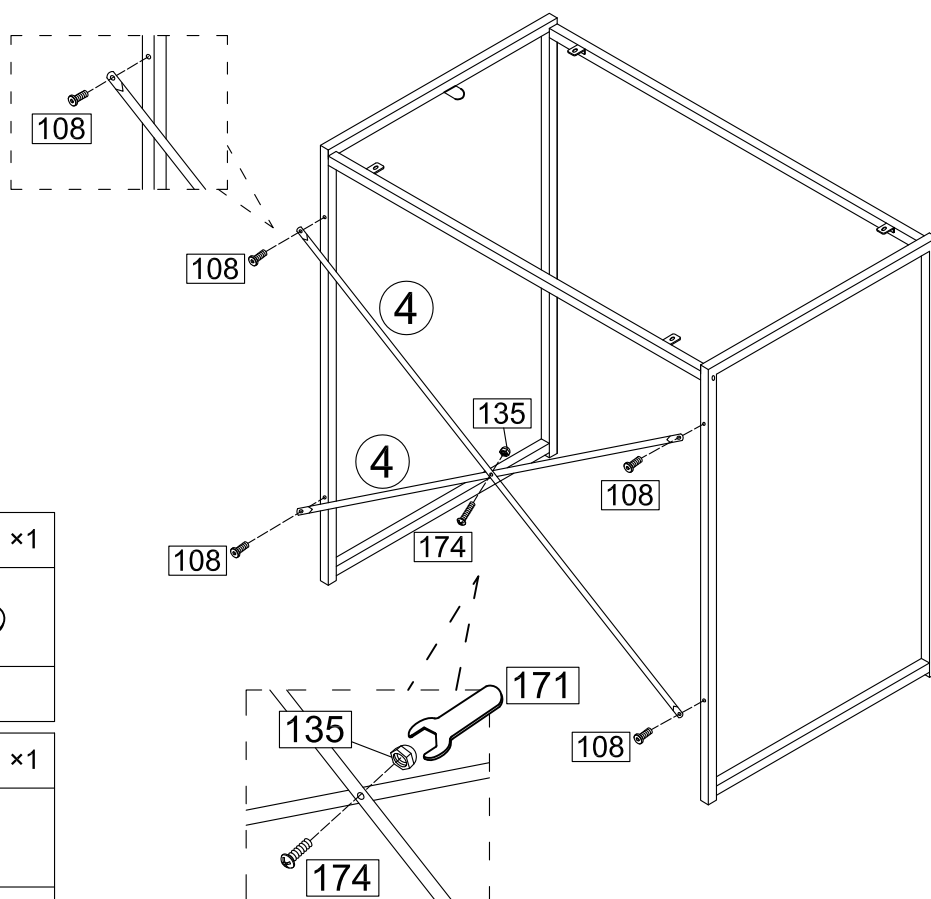

| | |
|--|----|
| 126 | X4 |
|  | |
| M6x35mm | |
| 112 | X1 |
|  | |
| 4mm | |

2





| | |
|---|----|
| 174 | x1 |
|  | |
| M4x20mm | |
| 108 | x4 |
|  | |
| M6x12mm | |
| 112 | x1 |
|  | |
| 4mm | |

| | |
|---|----|
| 171 | x1 |
|  | |
| M4 | |
| 135 | x1 |
|  | |
| M4 | |

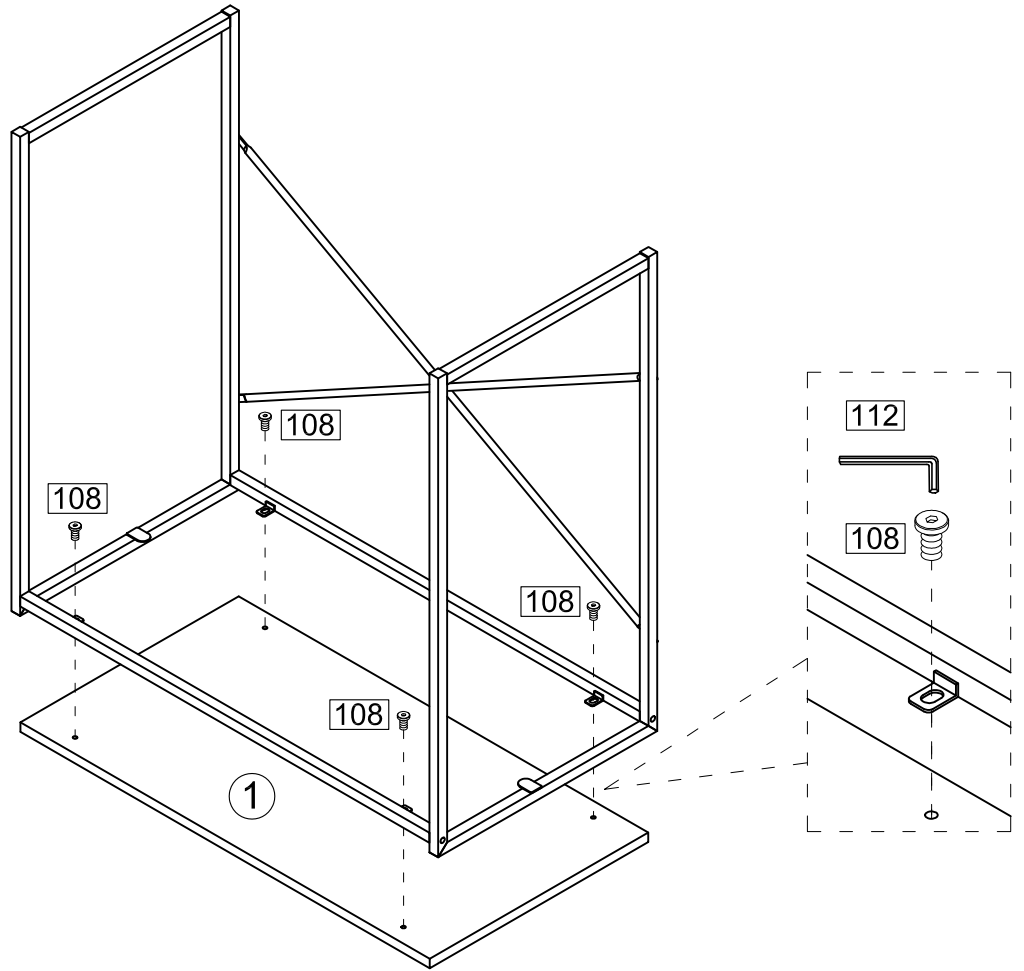
3



| | |
|--|----|
| 108 | X4 |
|  | |
| M6x12mm | |
| 112 | X1 |
|  | |
| 4mm | |

4

