

REFERENCE NO.	4894223195294 4894223219884 4894223219877	NOIR&GRIS/ BLACK&GREY BLEU/BLEUE ROUGE/RED
NOM DU PRODUIT	CARBON	
EAN:	4894223195294 4894223219884 4894223219877	NOIR&GRIS/ BLACK&GREY BLEU/BLEUE ROUGE/RED

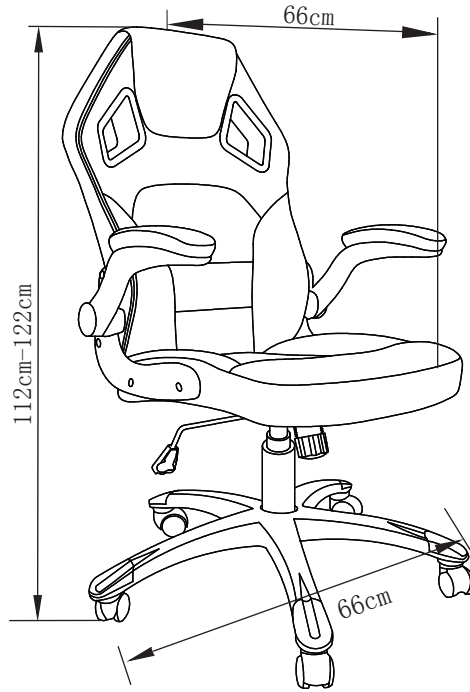

FAITES UN GESTE ECOCITOYEN
 EN TRIANT VOS EMBALLAGES CARTON

A LA FIN DE VIE DE VOTRE PRODUIT, VOUS
 POUVEZ LE DONNER À UNE STRUCTURE DE
 REEMPLOI SI IL EST EN BON ÉTAT, SINON LE
 DEPOSER À LA DECHETERIE PROCHE DE
 VOTRE DOMICILE



1. Repérez les différentes pièces nécessaires à l'assemblage de votre meuble.
 2. Regroupez et comptez les pièces de quincaillerie.
 3. Munissez-vous de l'outillage nécessaire à l'assemblage de votre meuble.
 4. Aménagez-vous un espace propice à l'assemblage; moquette et couverture peuvent protéger votre meuble des rayures
 5. Procédez au montage sans forcer. Il est recommandé de resserrer les vis au fil de l'utilisation.
 6. Après assemblage de ce produit, il est conseillé d'aérer régulièrement la pièce pendant quelques jours.
- CONSERVEZ VOTRE NOTICE DE MONTAGE. SI UNE PIÈCE VENAIT À MANQUER, L'INFORMATION RELATIVE À CELLE-CI FOURNIE PAR LA NOTICE DE MONTAGE RESTE LE MOYEN LE PLUS EFFICACE



1. Identify the parts which make up your piece of furniture.
 2. Gather the hardware parts and count them.
 3. Have the necessary assembly tools ready.
 4. Organize a space for assembly, wall carpeting or a blanket will protect the furniture against scratches.
 5. Never force the assembling while you put the parts together. You are recommended to tighten the screws after the furniture has been used for some time.
 6. After assembling this product, it is advisable to regularly ventilate the room for a few days.
- KEEP THE ASSEMBLY INSTRUCTION. THE RELEVANT INFORMATION YOU CAN FIND ON IT WILL HELP YOU GET IN TOUCH WITH YOUR STORE IF A PART WAS TO BE MISSING.

SEUL UN PERSONNEL QUALIFIE EST APTE A REPARER OU CHANGER LE VERIN A GAZ(IMPORTANT
 NOTICE:ONLY TRAINED PERSONEL MAY REPLACE OR REPAIR THE GASLIFT OF THE CHAIR.)

Meuble à usage domestique / House furniture

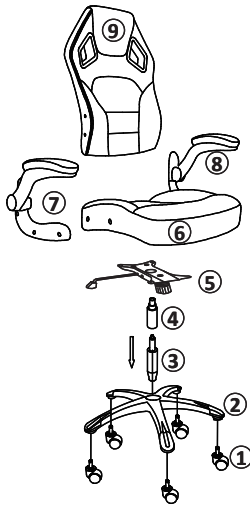

No.	Taille	Qté	Ctn no.
No.	Size	Qty	Ctn no.
No.	Tamaño	Cant	Ctn no.
Nr.	Maße	Anz	Ktn nr.
1	D50mm	5	1
2	R350mm	1	1
3	D(28-50)*(250-350)mm	1	1
4	285*100mm	1	1
5	178*280mm	1	1
6	510*490*100mm	1	1
7	430*320*120mm	1	1

No.	Taille	Qté	Ctn no.
No.	Size	Qty	Ctn no.
No.	Tamaño	Cant	Ctn no.
Nr.	Maße	Anz	Ktn nr.
8	430*320*120mm	1	1
9	740*550*150mm	1	1
10			
11			
12			
13			
14			

No.	Taille	Qté	Ctn no.
No.	Size	Qty	Ctn no.
No.	Tamaño	Cant	Ctn no.
Nr.	Maße	Anz	Ktn nr.

Quincailleries/Hardware/Herrajes/ Montageteile- Ctn no./Kto. nr. 1

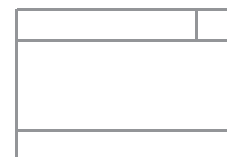
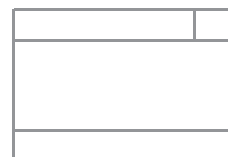
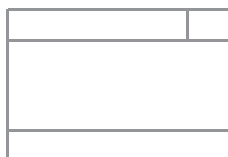
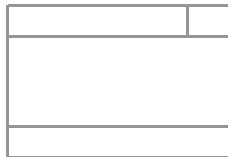
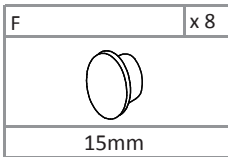
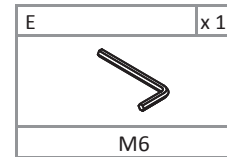
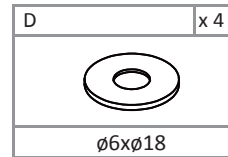
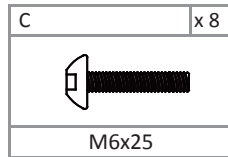
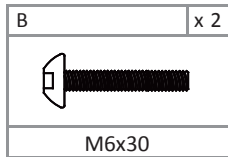
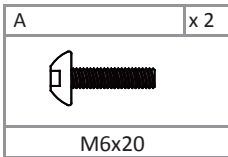

TEMPS DE MONTAGE: 20 MINUTE
SET-UP TIME: 20 MINUTE



OUTILLAGE:
TOOLS:



NOMBRE DE PERSONNES: 02
NUMBER OF PERSONS: 02



POUR L'ENTRETIEN, UN CHIFFON DOUX SUFFIRA.
A SOFT CLOTH IS SUITABLE FOR PRODUCT CARE.

SAV / Spare Parts		EAN: 2099901387264	
(No. / Nr)x(Qté/Qty)			
AX2	EX1		
BX2	FX8		
CX8			
DX4			



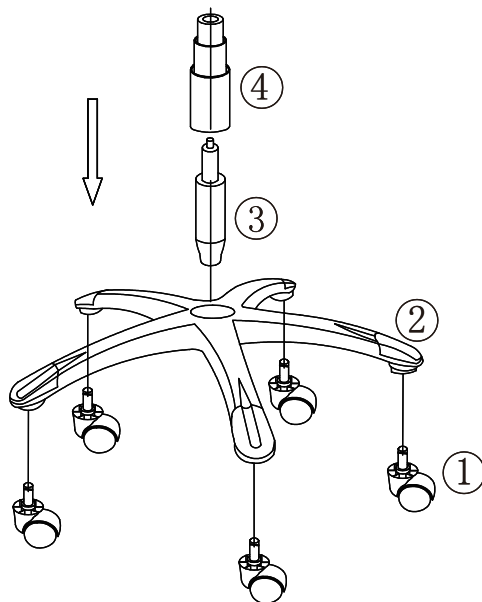

Meuble à usage domestique / House furniture

1

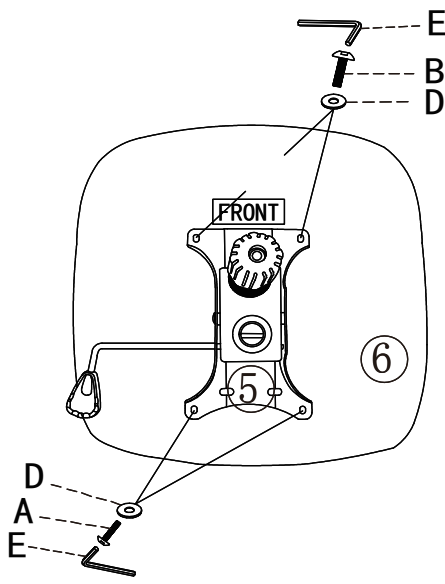

2



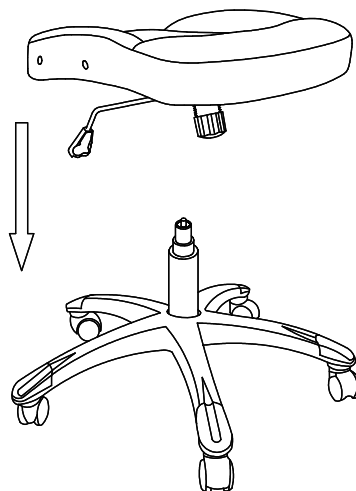

A	x2	B	x2	D	x4	E	x1
							
M6*20		M6*30		Ø6*Ø18		M6	

3



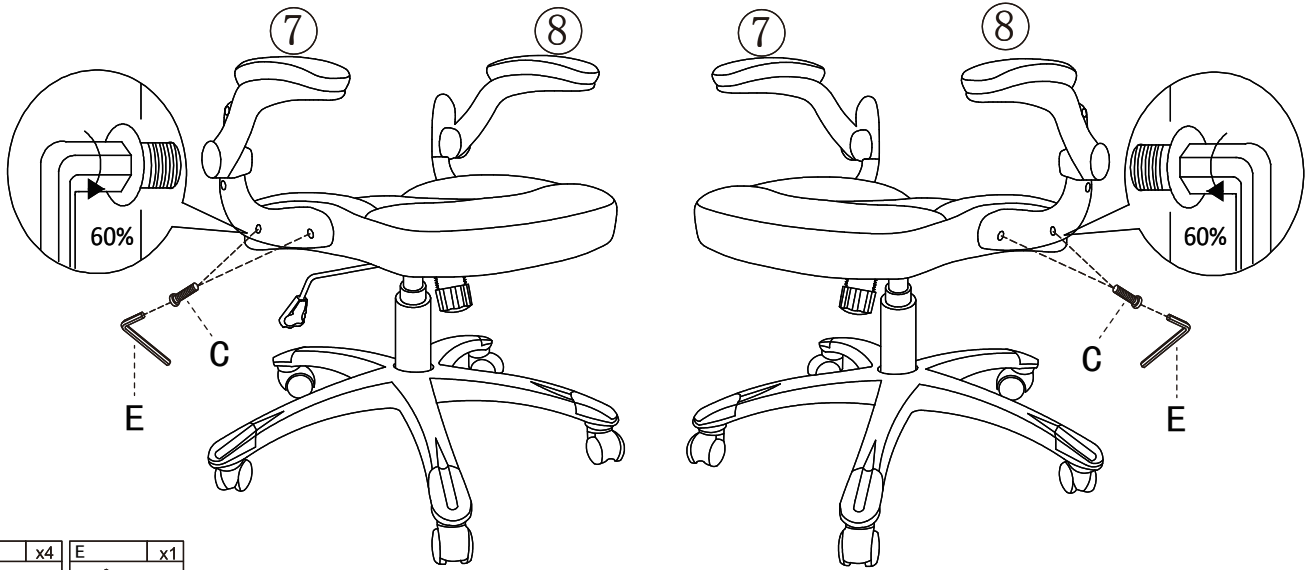

4

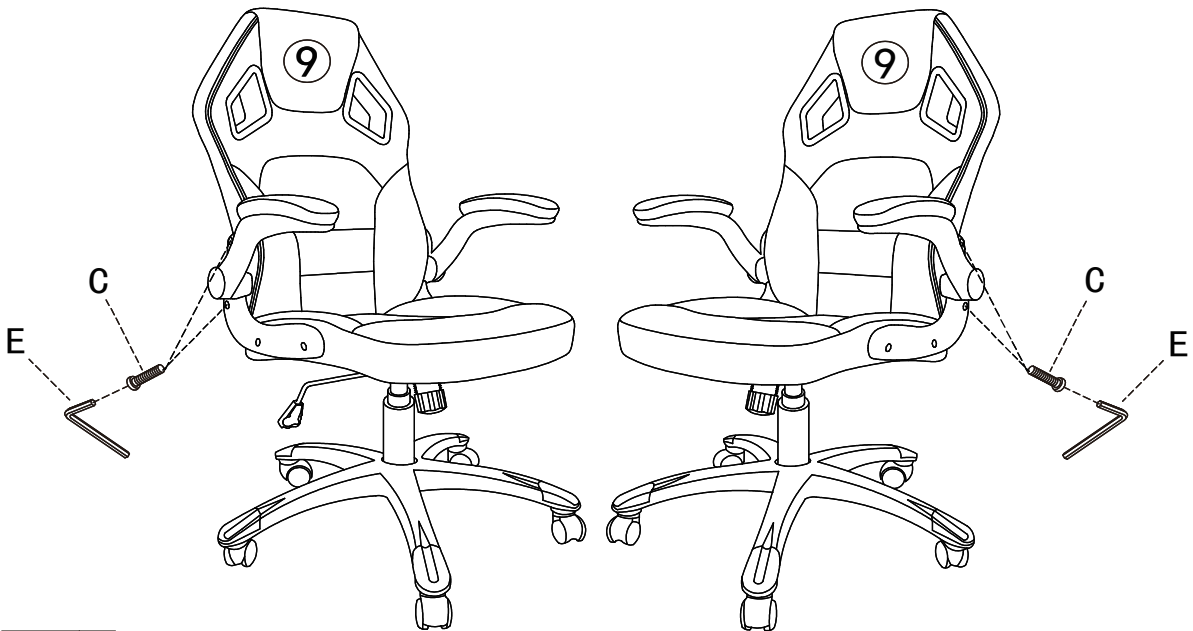

C	x4	E	x1
			
M6*25		M6	

5



C	x4	E	x1
			
M6*25		M6	

6

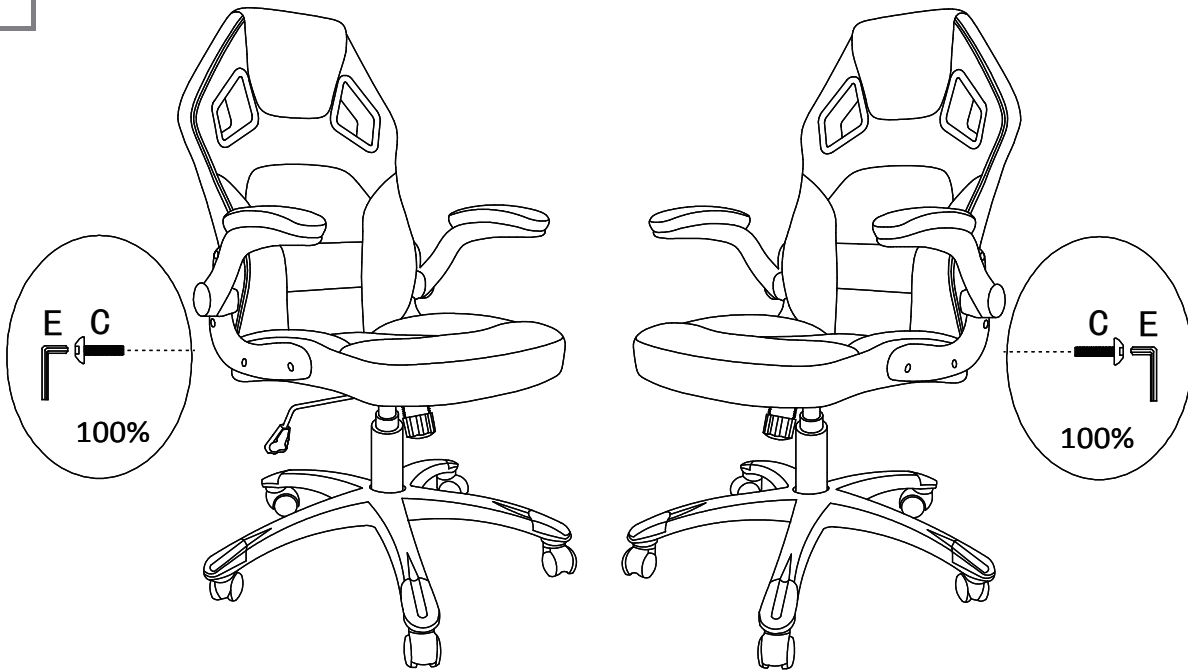

7

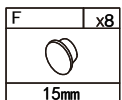
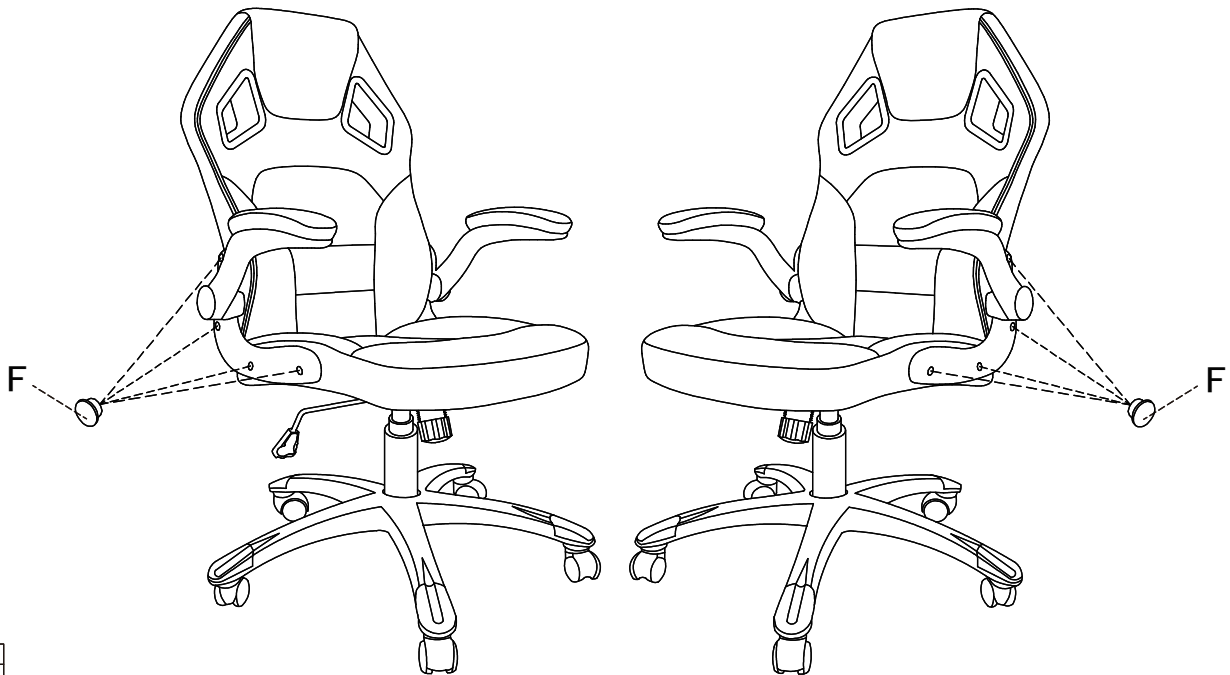

8

