

MARIA 83-698-__-6

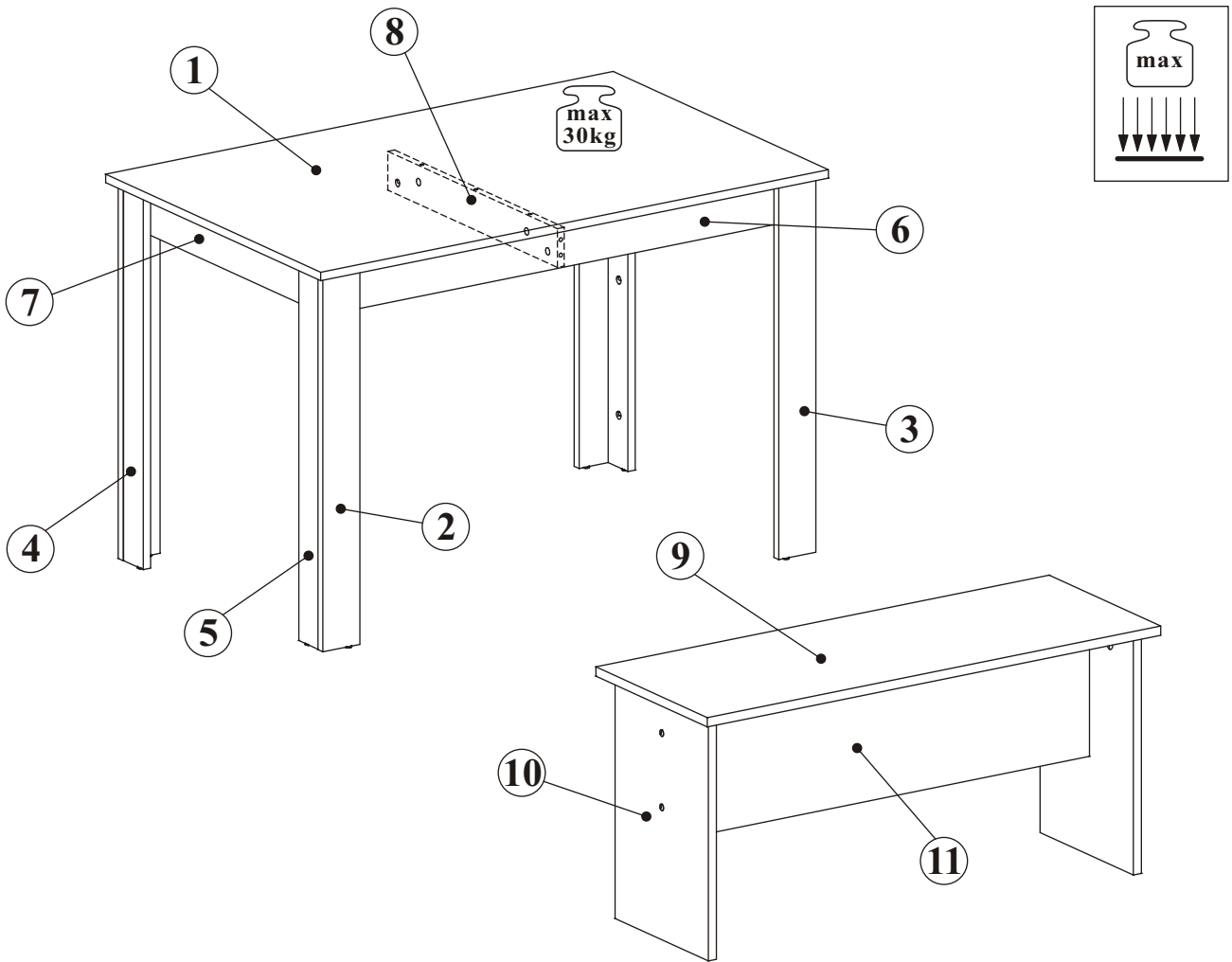

NO	Dim.		Col.-No	Qty
1	1100	700	1	1
4	710	64	1	2
5	710	64	1	2
2	710	80	1	2
3	710	80	1	2
6	1034	80	1	2
7	602	80	1	2
8	602	80	1	1
9	894	330	1	2
11	822	244	1	2
10	414	276	1	4

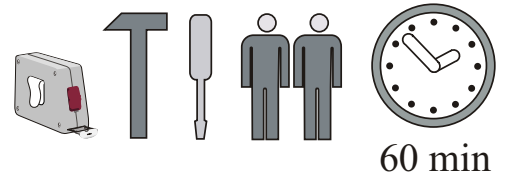

MARIA 83-698-__-6

A1 x43 ø8x36	B4 x40	B5 x40 Ø15x12	G5 x36	UP6 x12 UPØ4x30	I2 x12
B11 x12 Ø7x50	G4 x8	G1 x2	G2 x1		

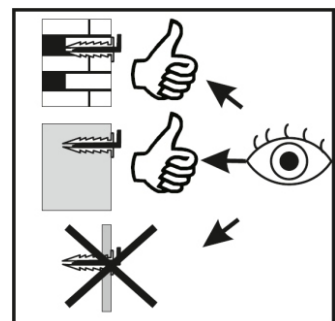
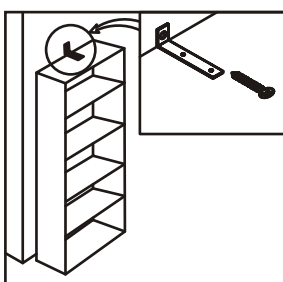
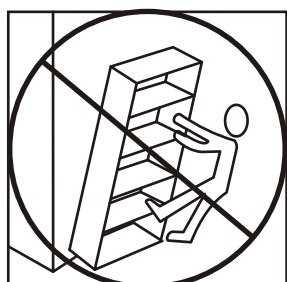
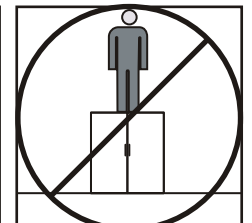
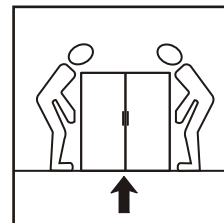
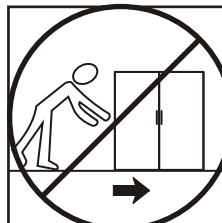
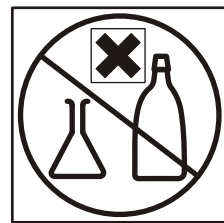
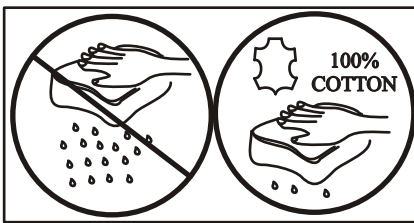
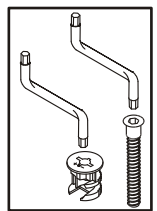
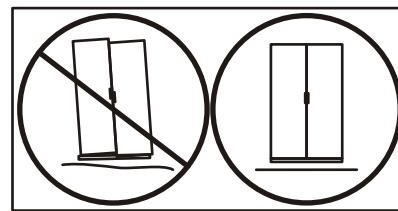
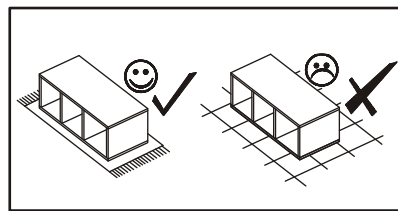
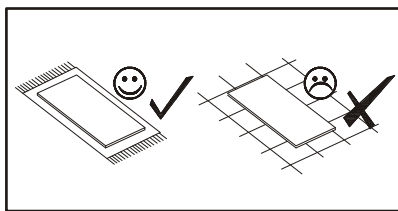
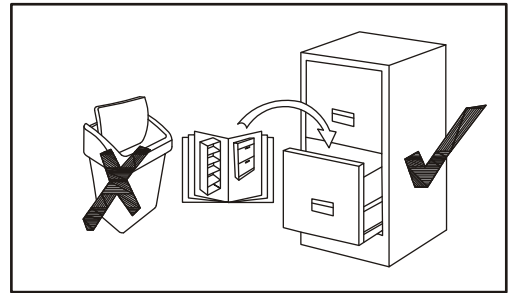
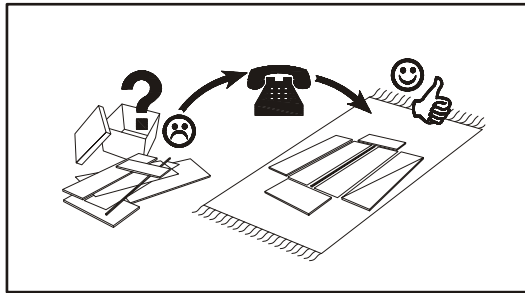
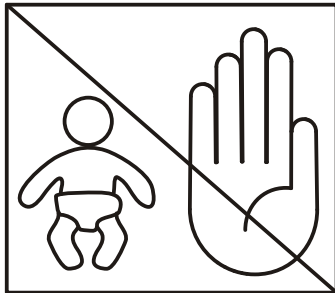
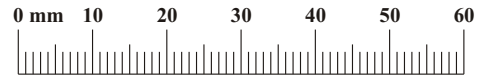

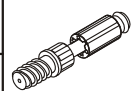
B4	
x14	

1

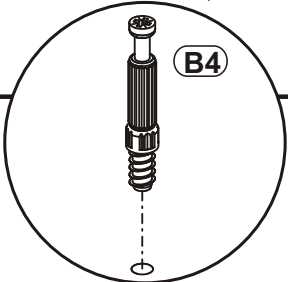
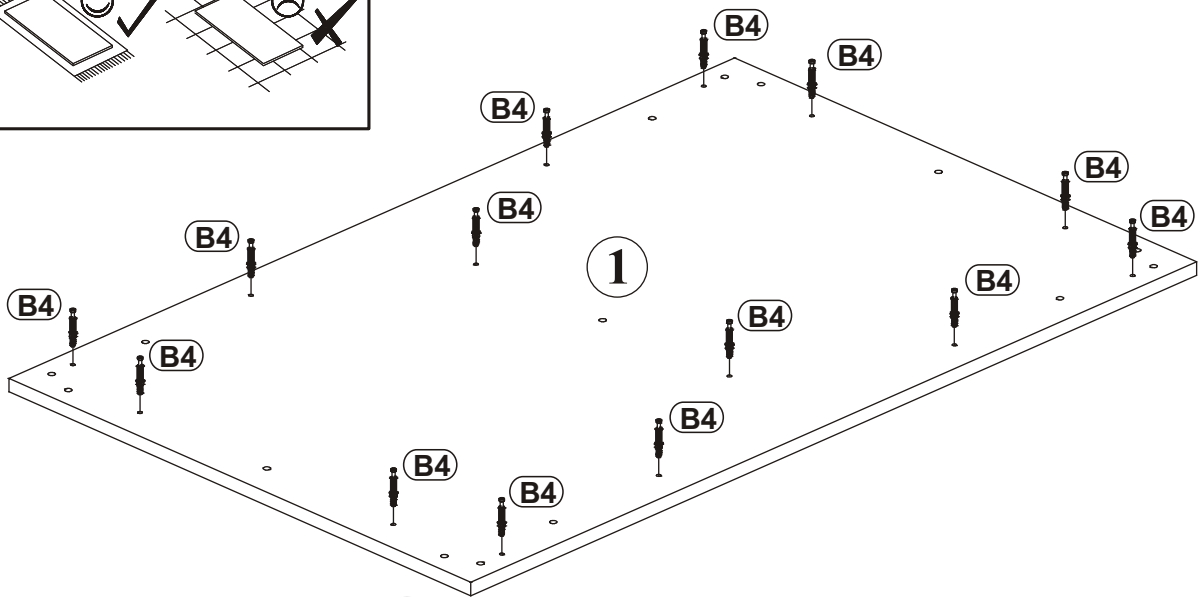
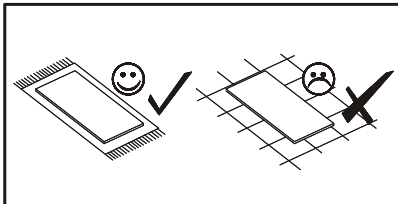

2

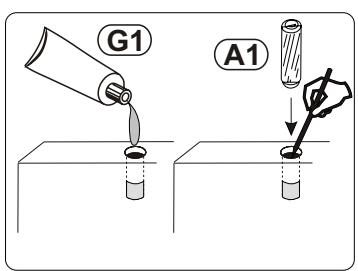

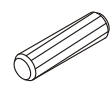
A1	
x13	ø8x36

B5	
x12	Ø15x12

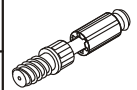
B4	
x2	

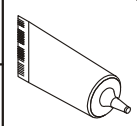
G1	
x2	

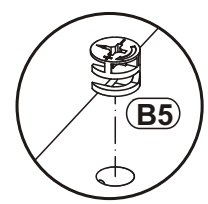
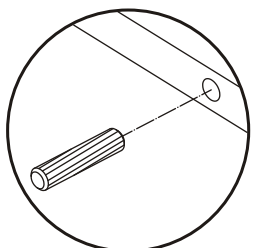
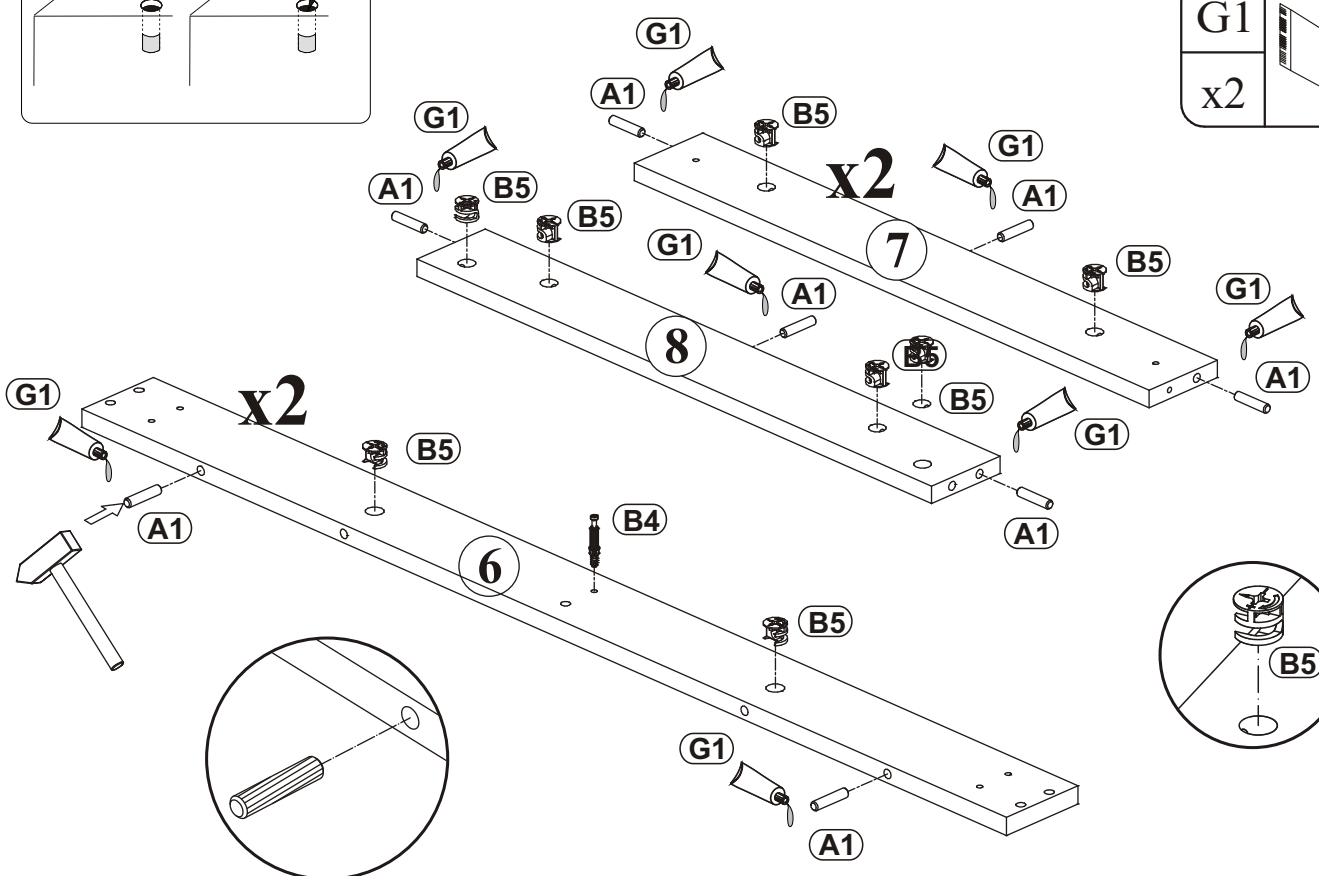

3

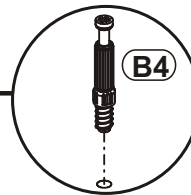
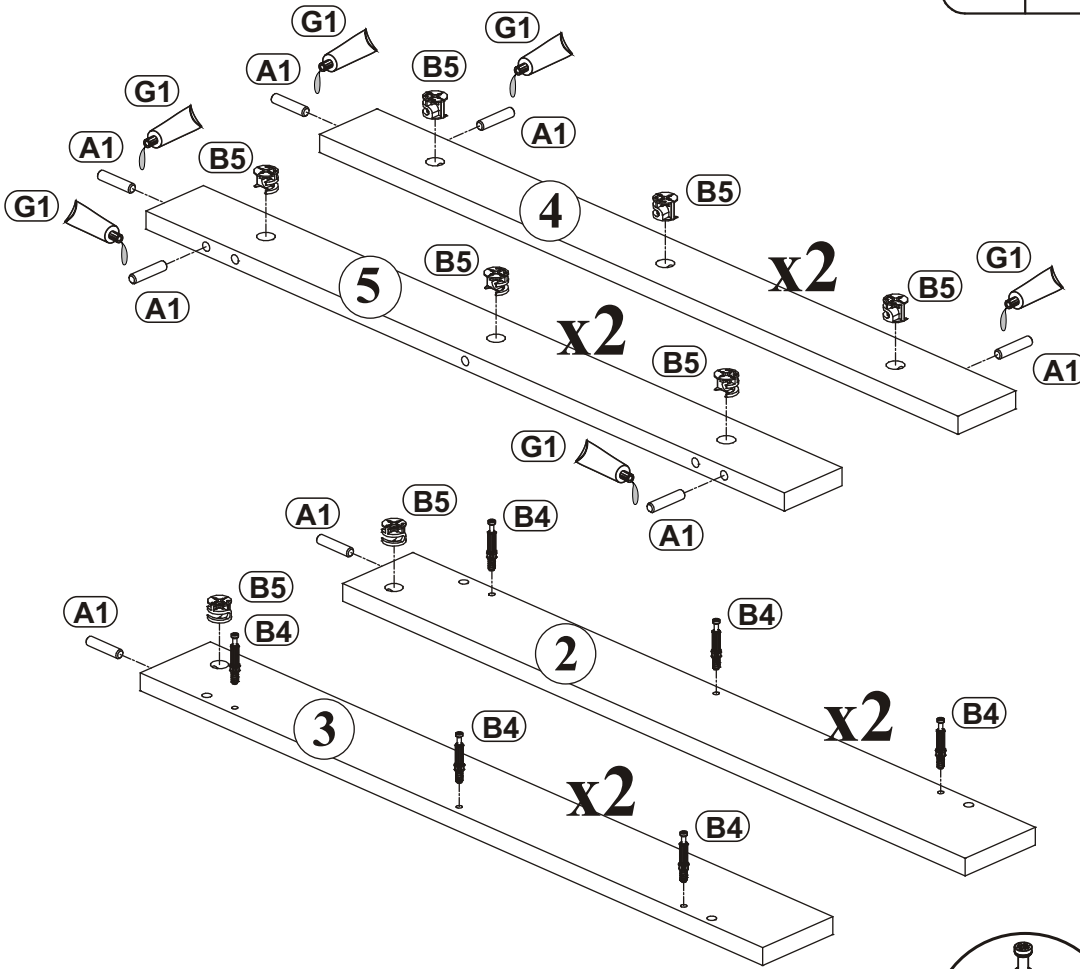
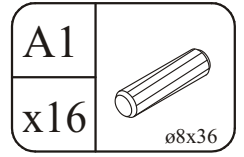
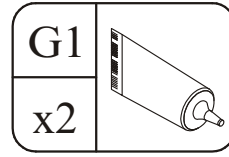
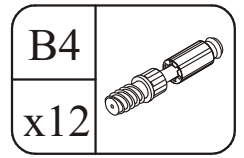
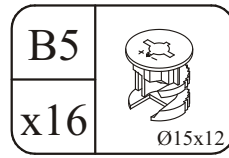
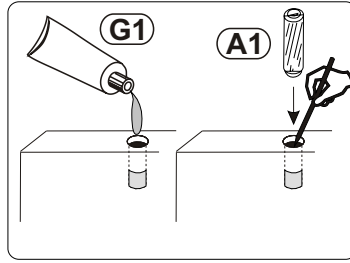

4

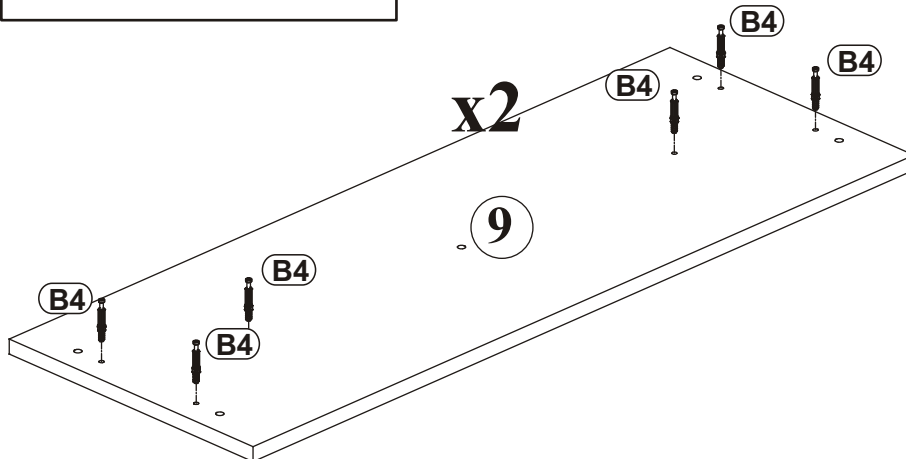
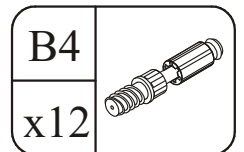
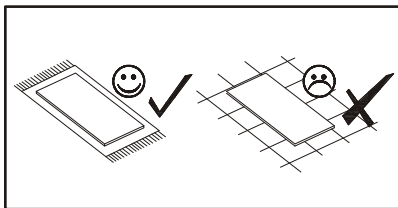

5

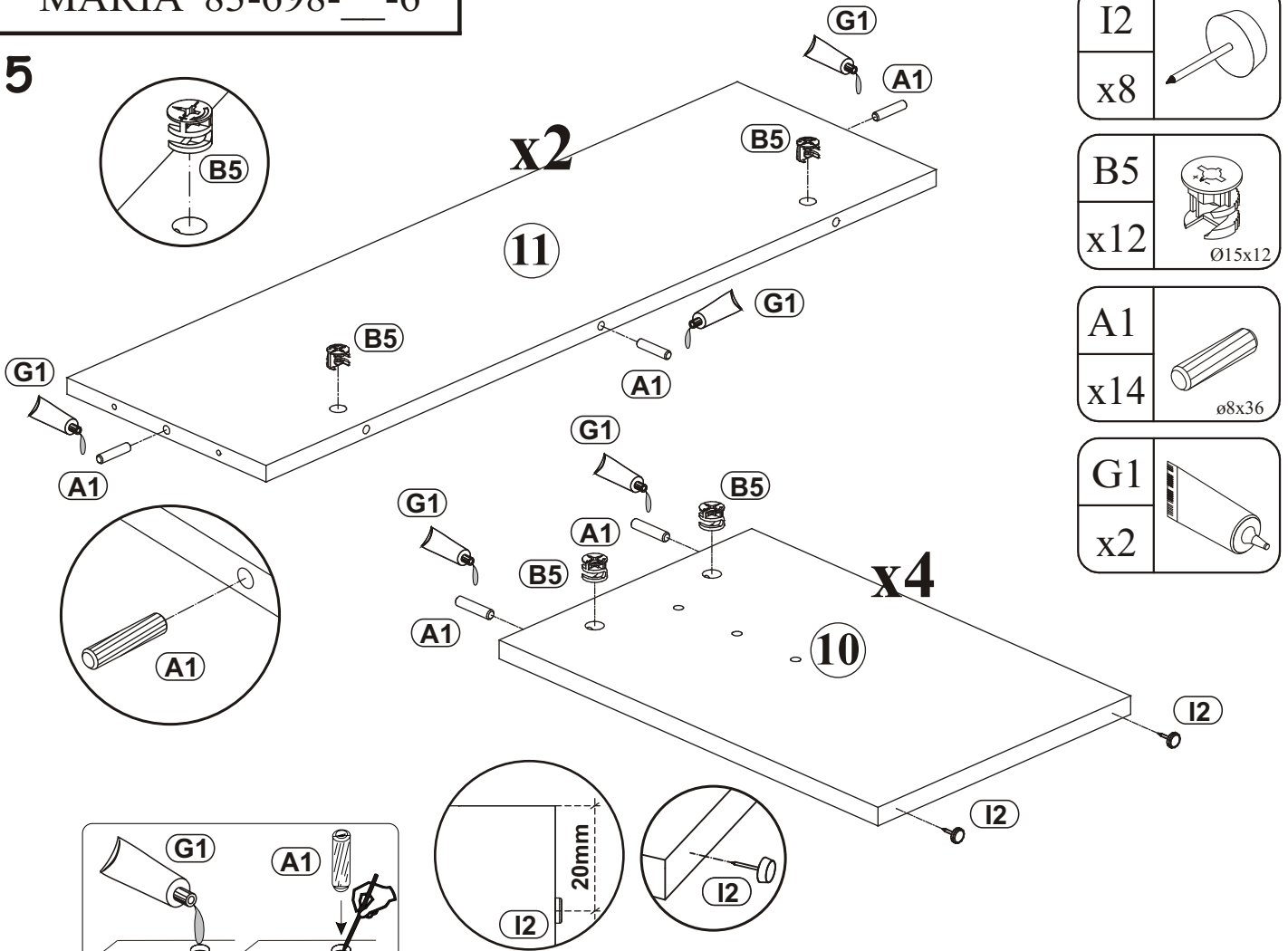

I2	
x8	

B5	
x12	Ø15x12

A1	
x14	Ø8x36

G1	
x2	

6

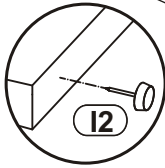
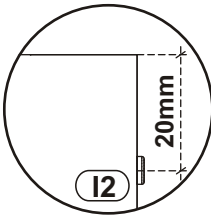
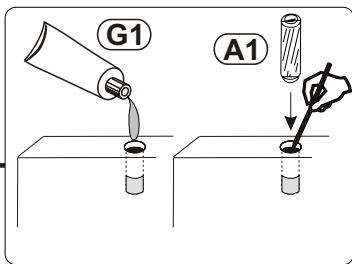

G5	
x2	

B11	
x4	Ø7x50

G1	
x2	

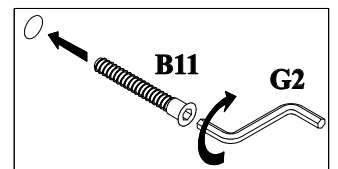
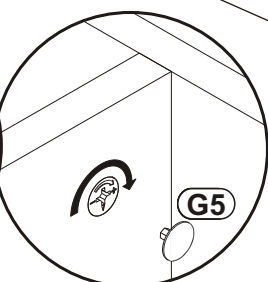
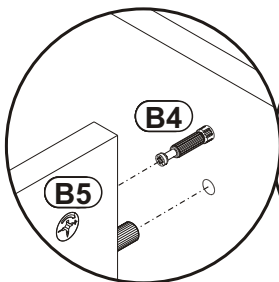
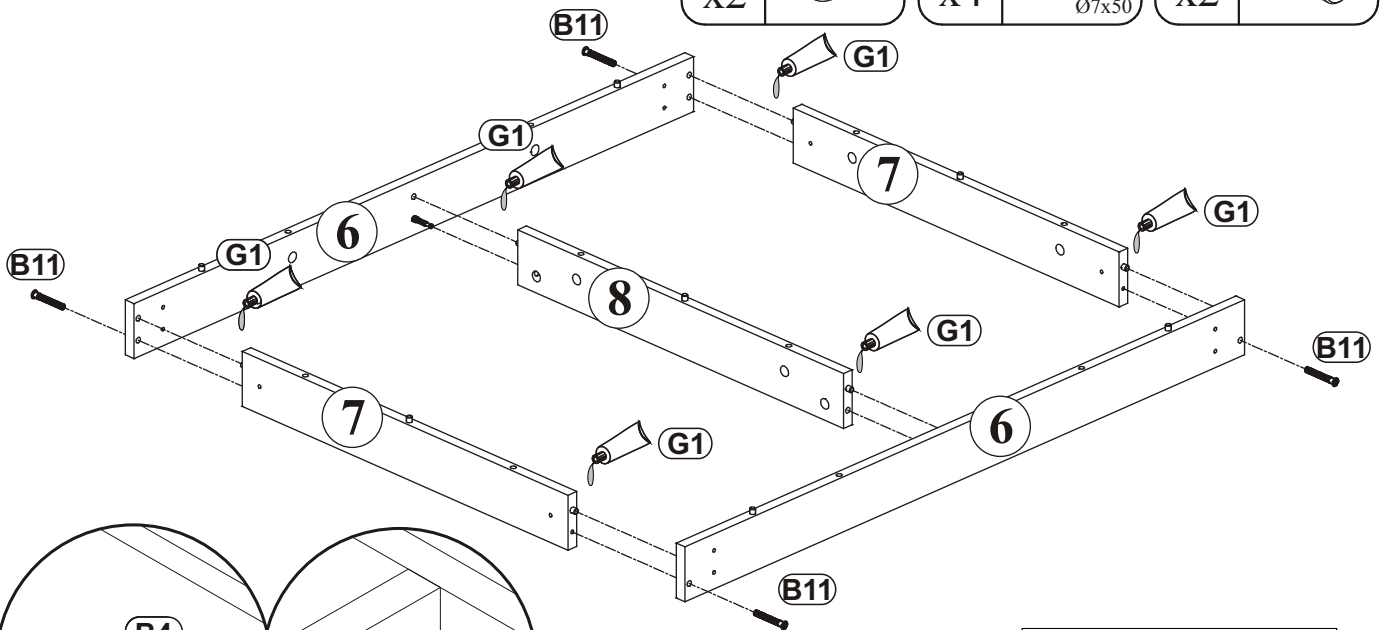

7

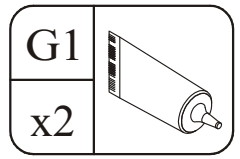
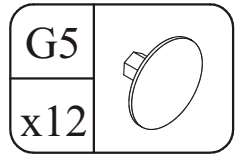
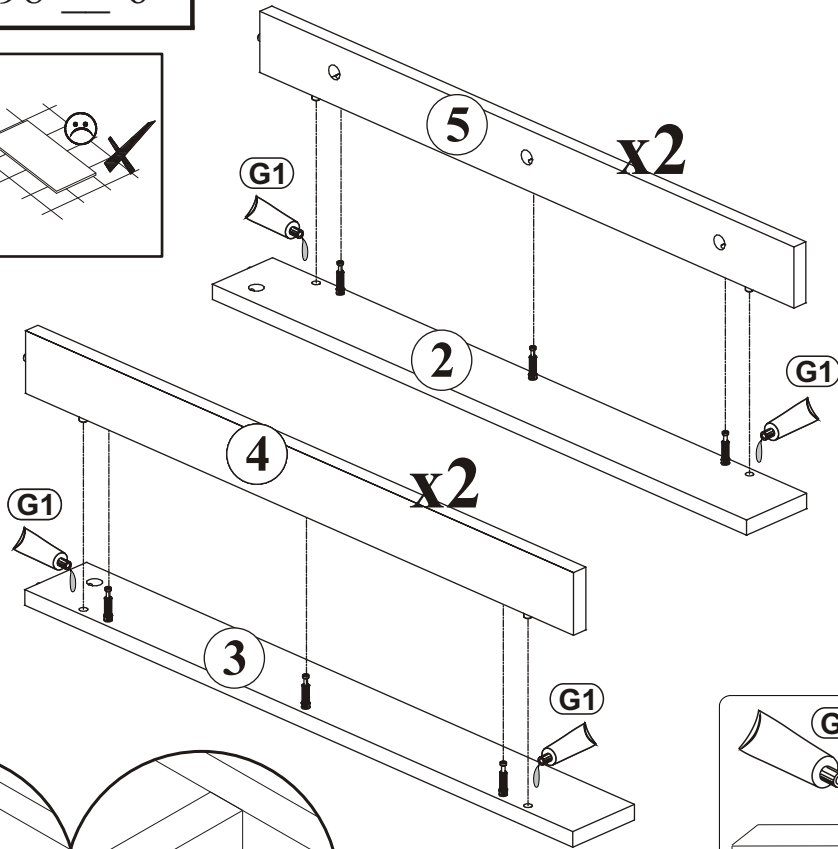
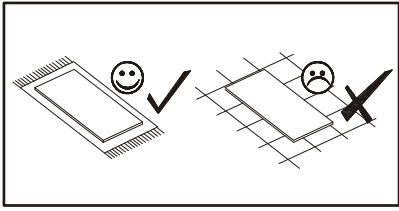

8

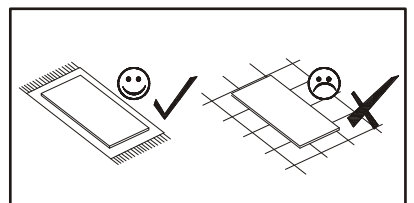
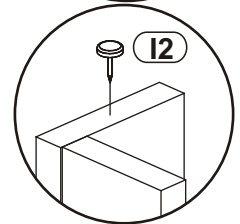
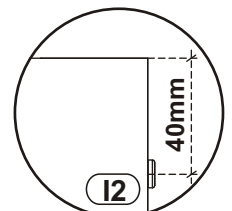
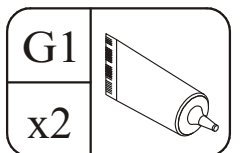
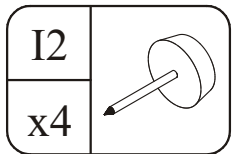
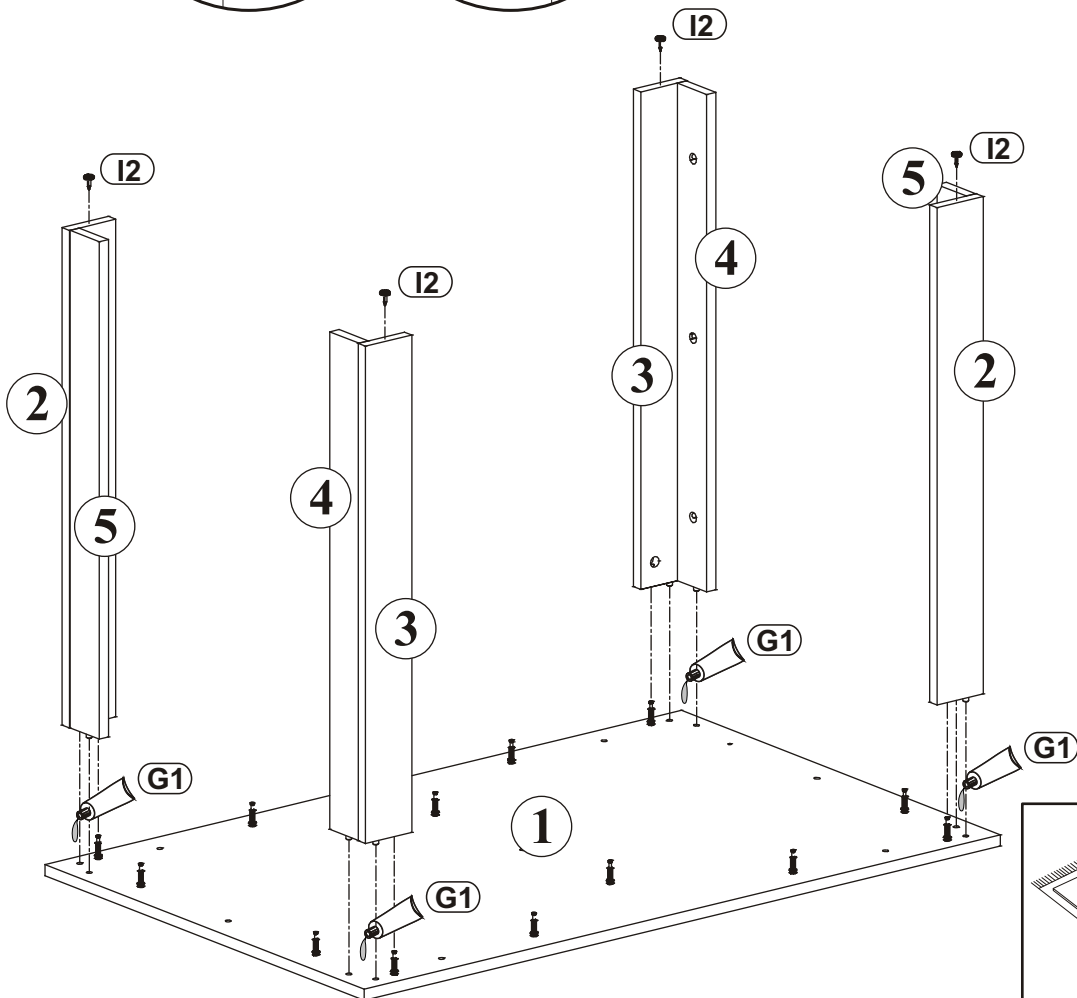
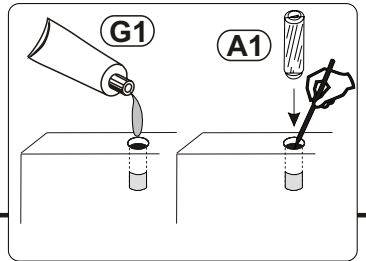
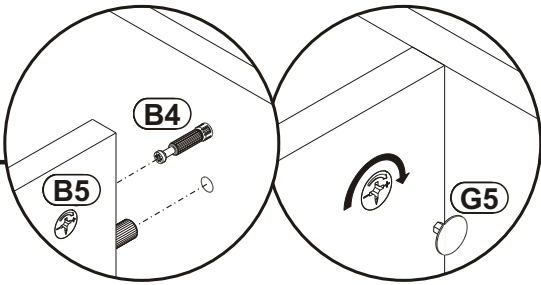

9

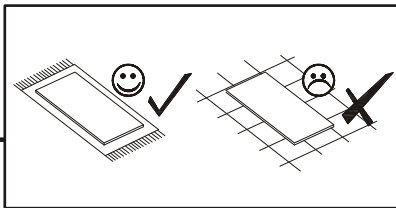
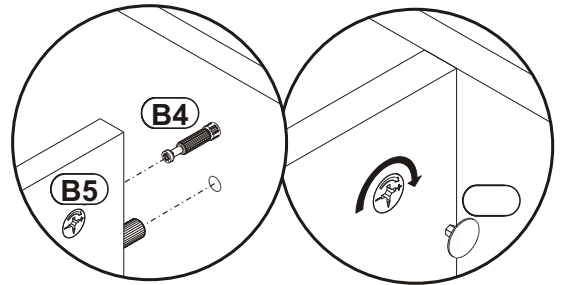
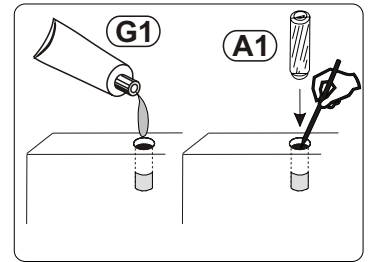
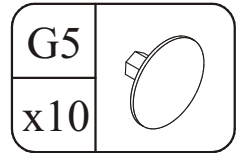
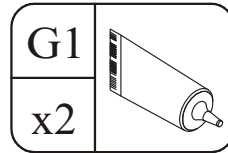
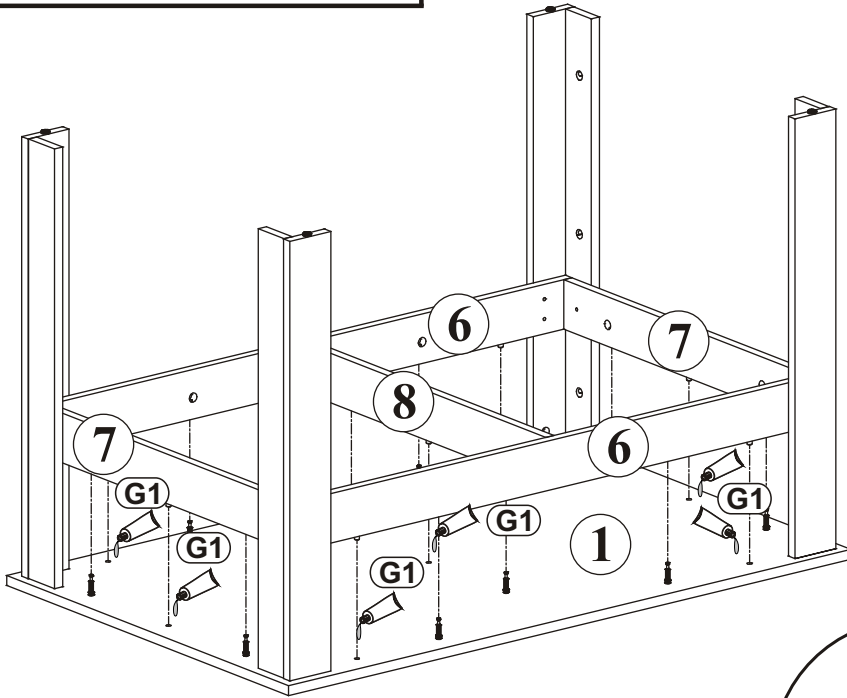

10

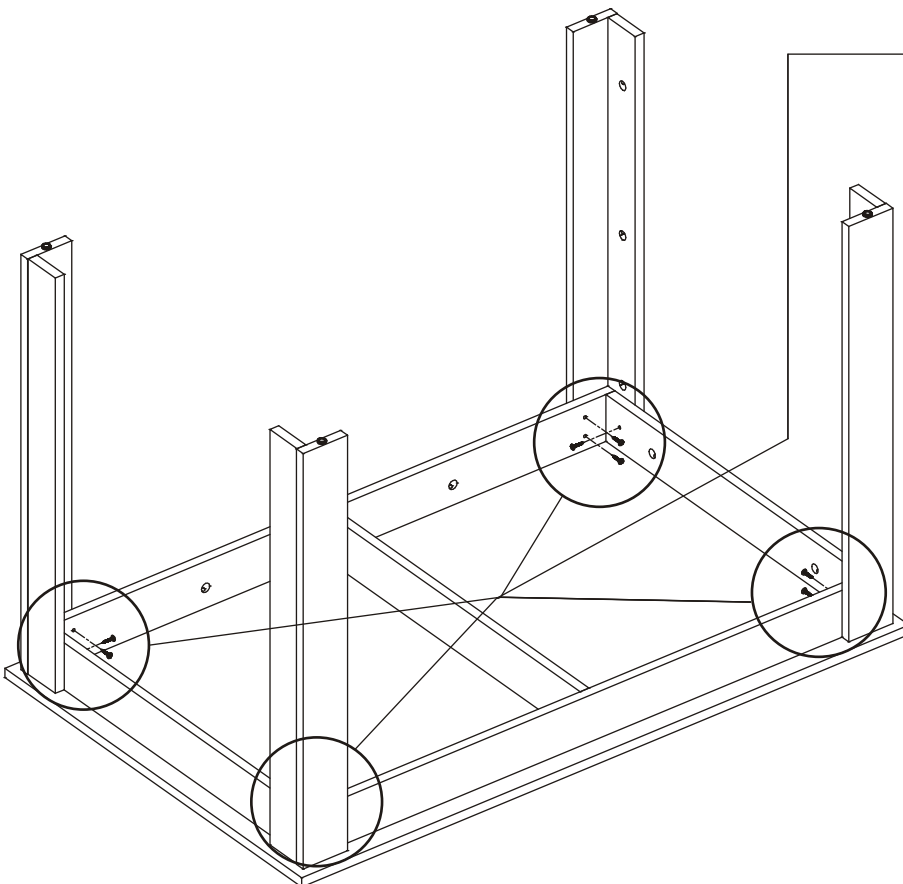
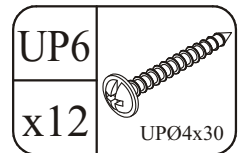
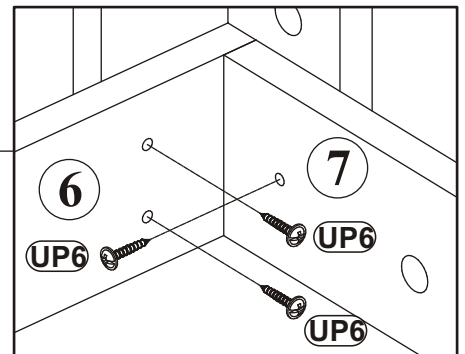

11

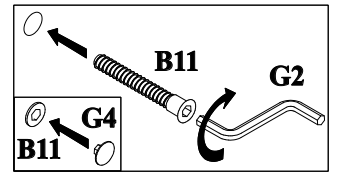
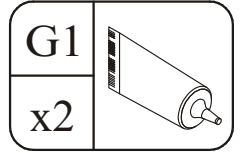
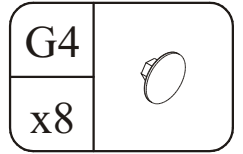
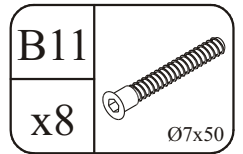
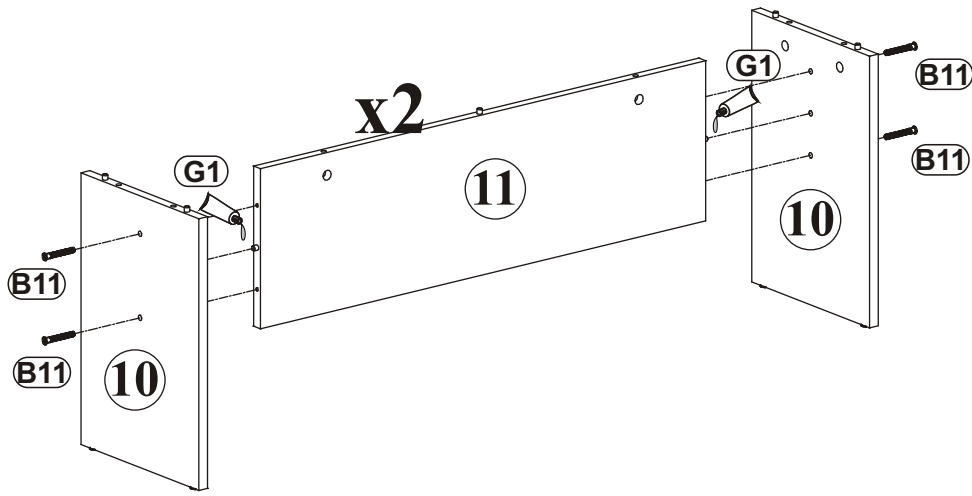

12

