

# Ref.T38141

R.0

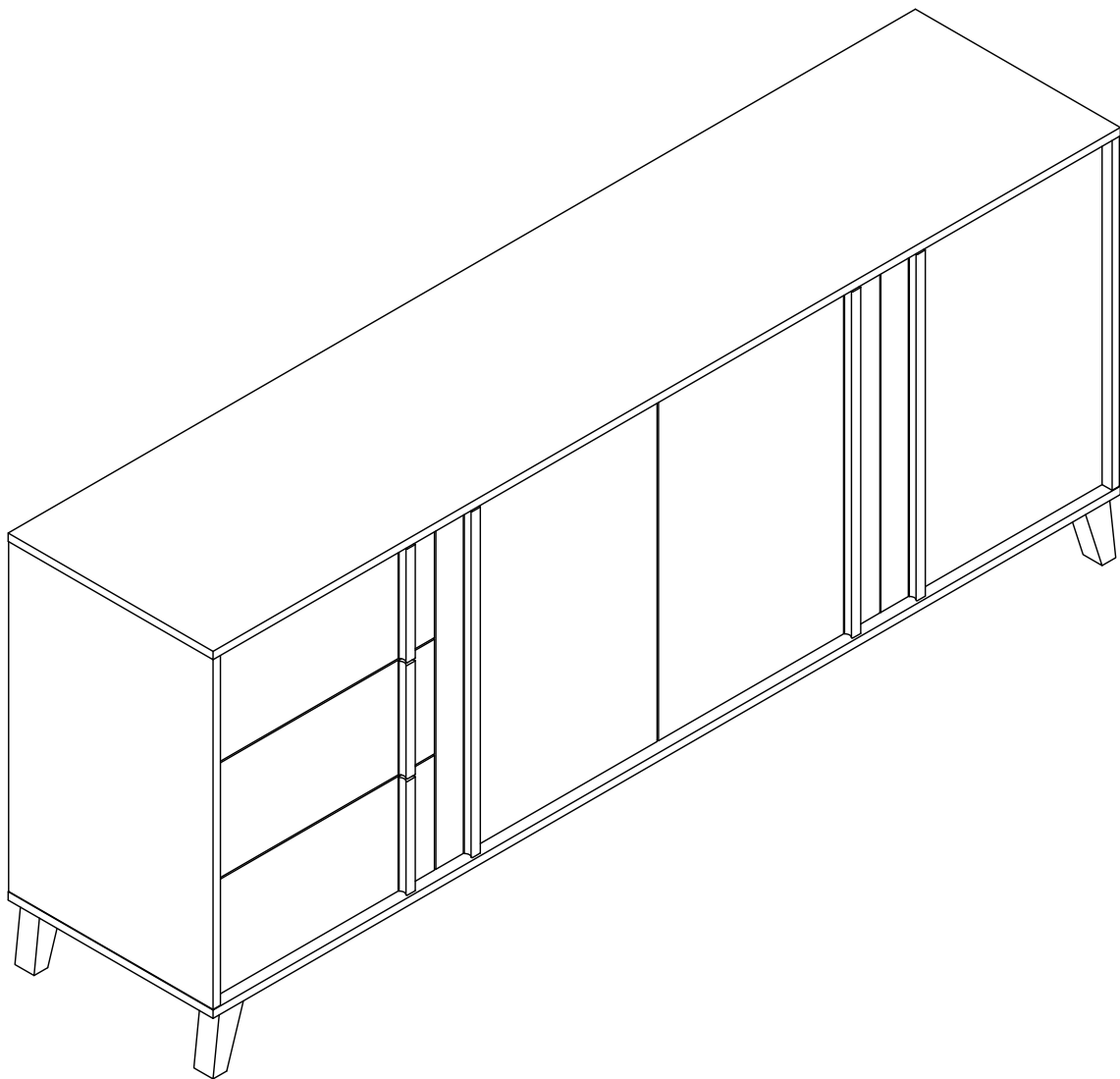

**talesa**  
tableros de levante, s.a.

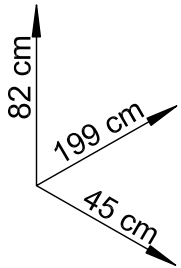
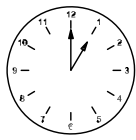
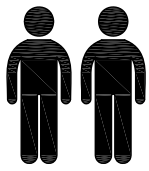

120 min.

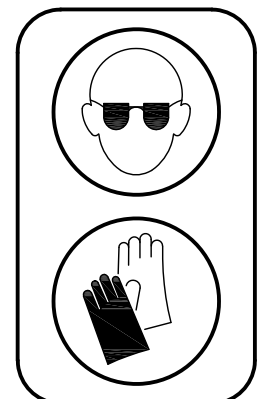
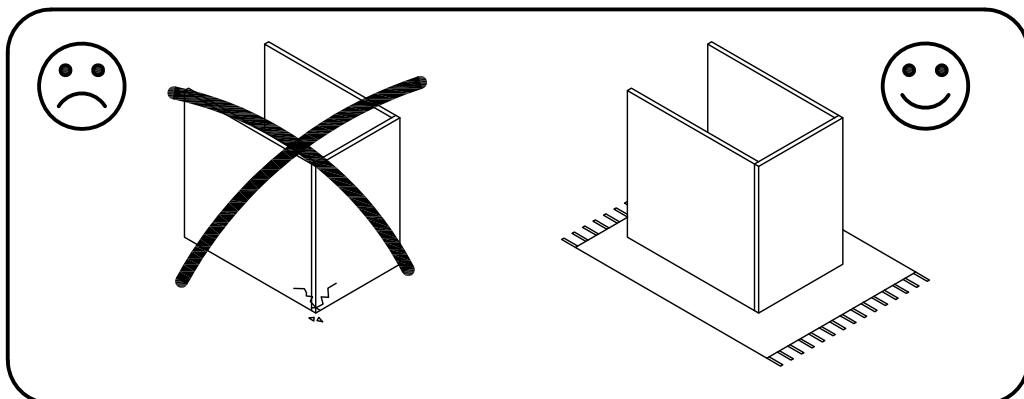
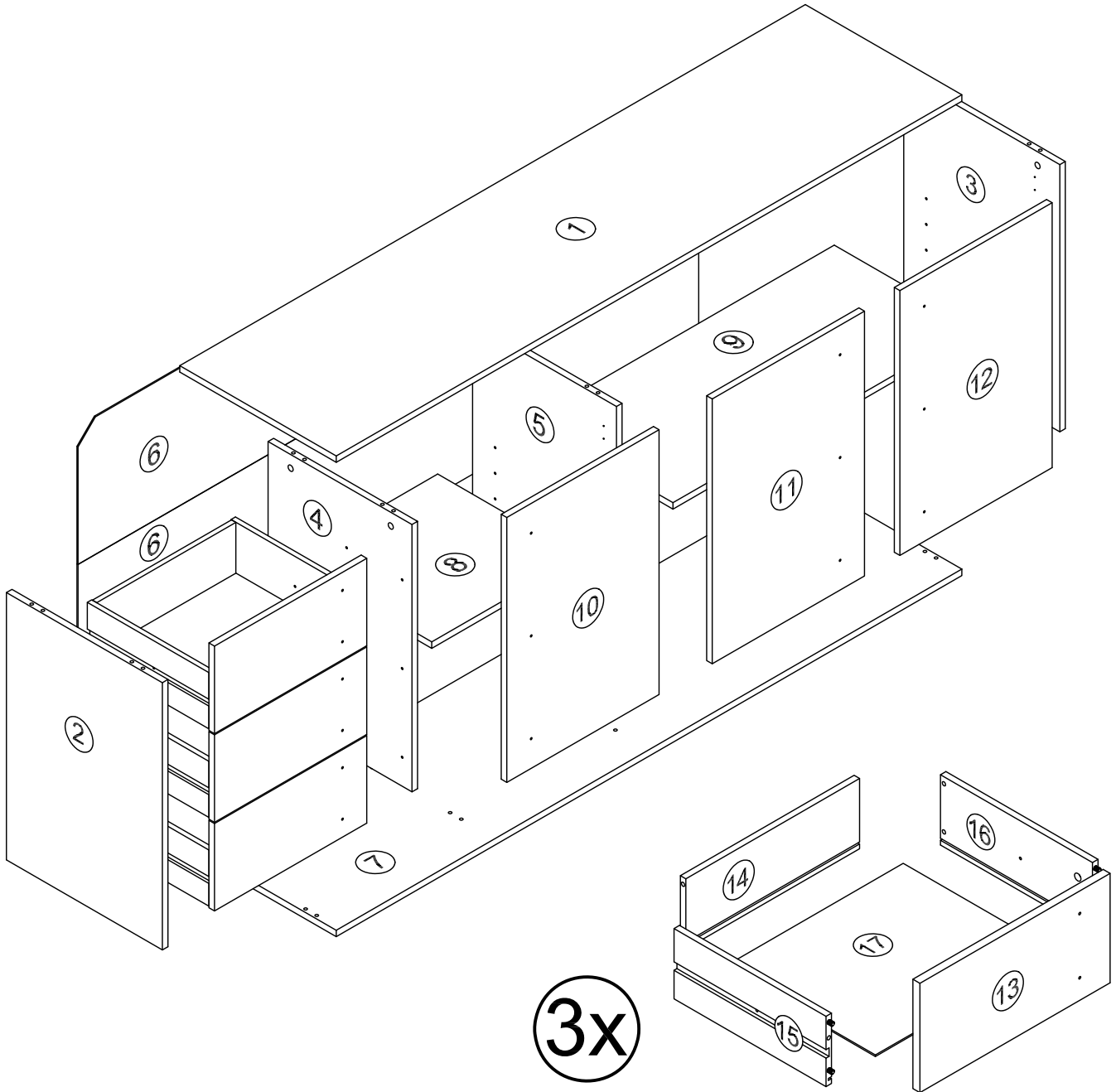
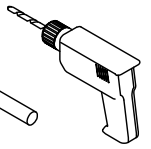
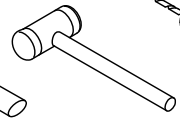
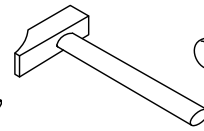
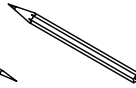
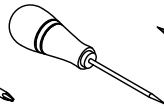
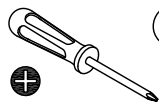

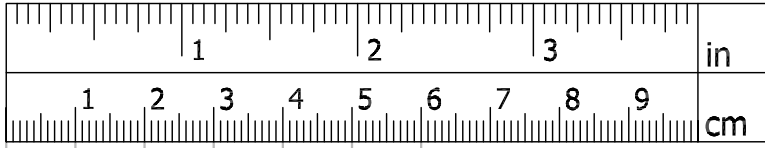

A x16

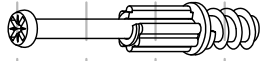

B x14



Ta x8

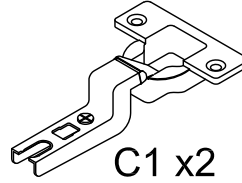

C1 x2

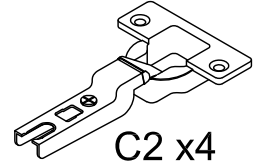

C2 x4



Tb x46

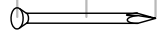

Tc x60



Td x15

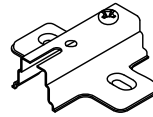

D x6

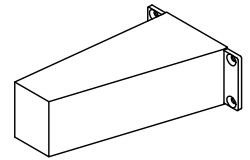

E x5



Te x6



Tf x12

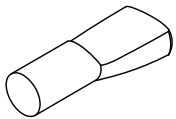

F x8

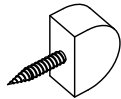

G x2



H x6



i x8

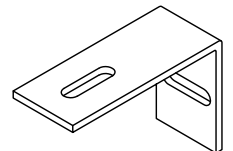

J x2

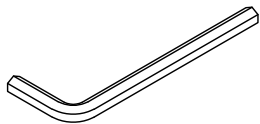

K x1

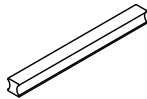

L1 x3

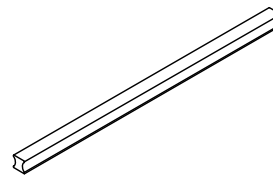

L2 x3

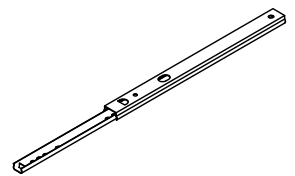

M x6

1

B x8

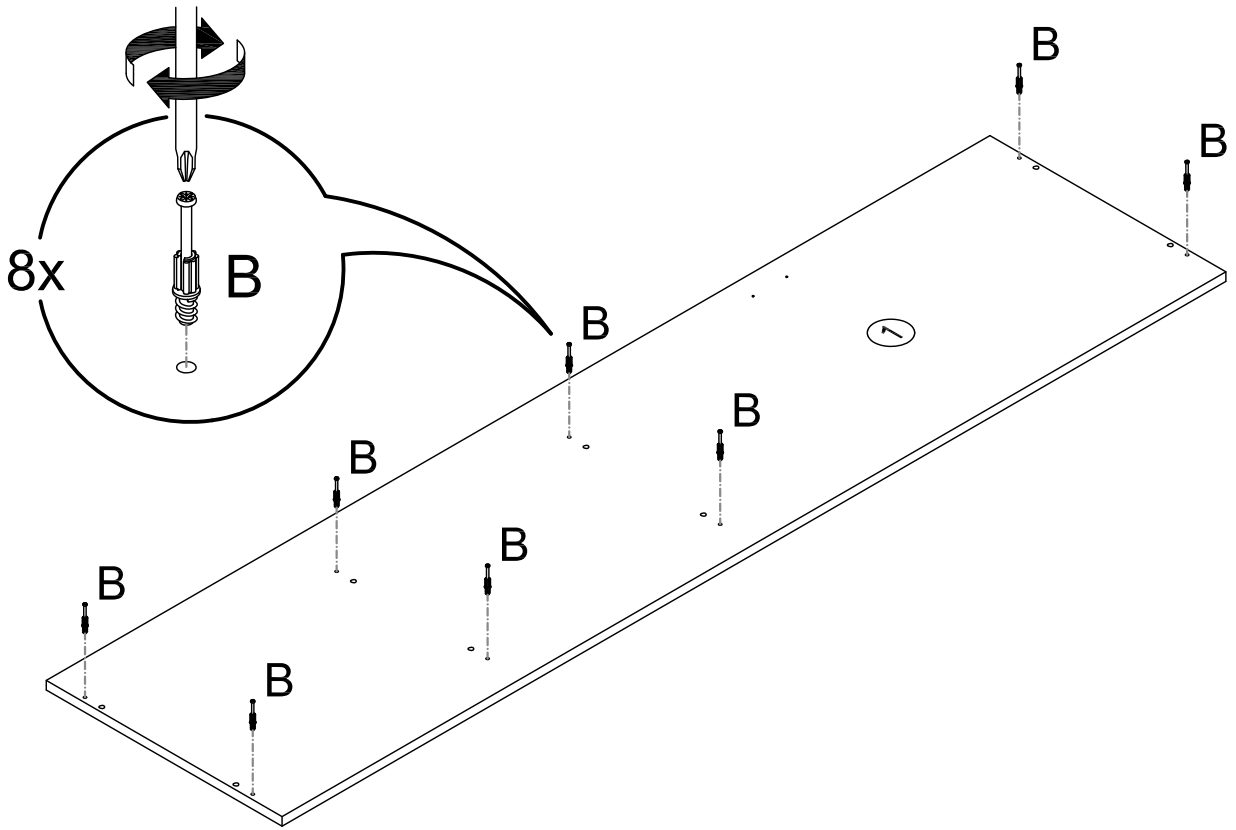
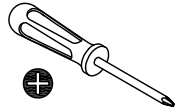

2

A x4 i x2

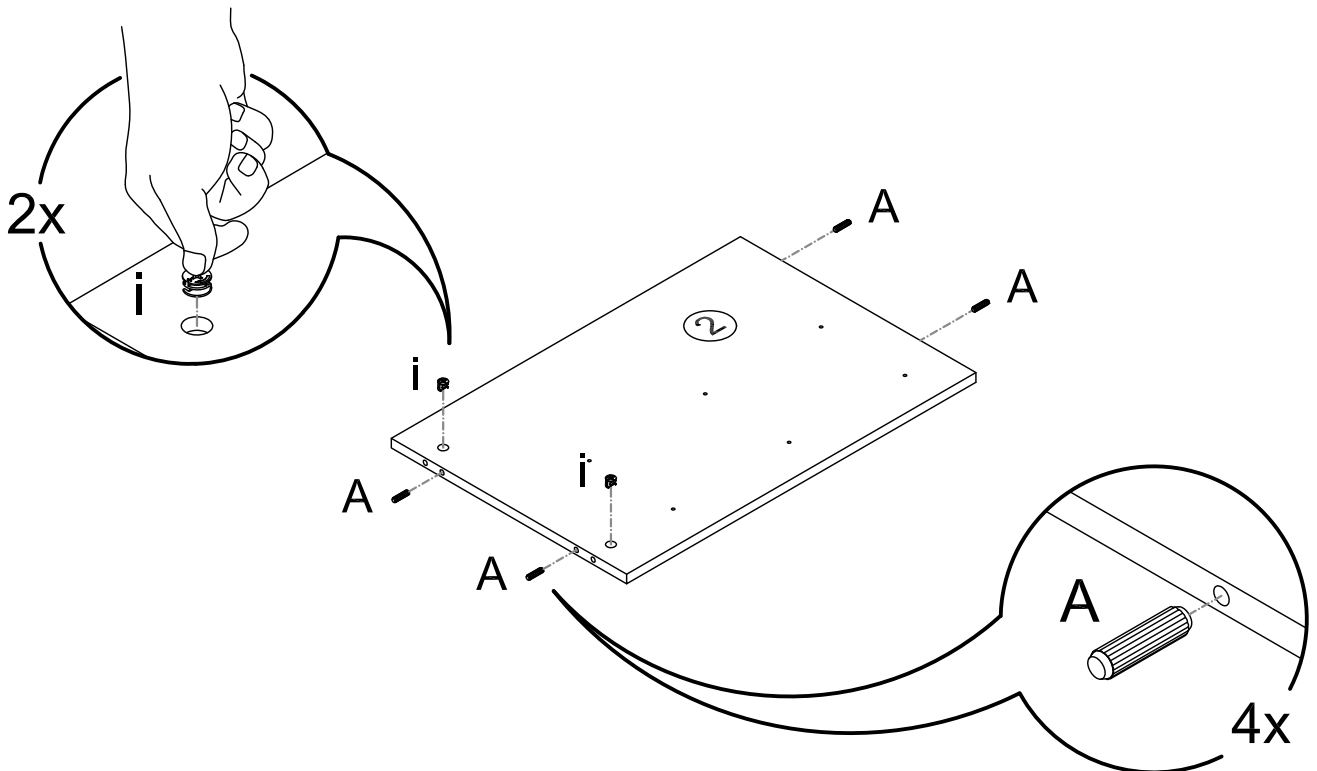
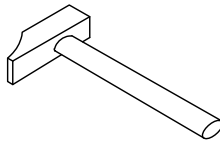

3

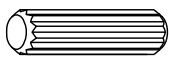

A x4



i x2

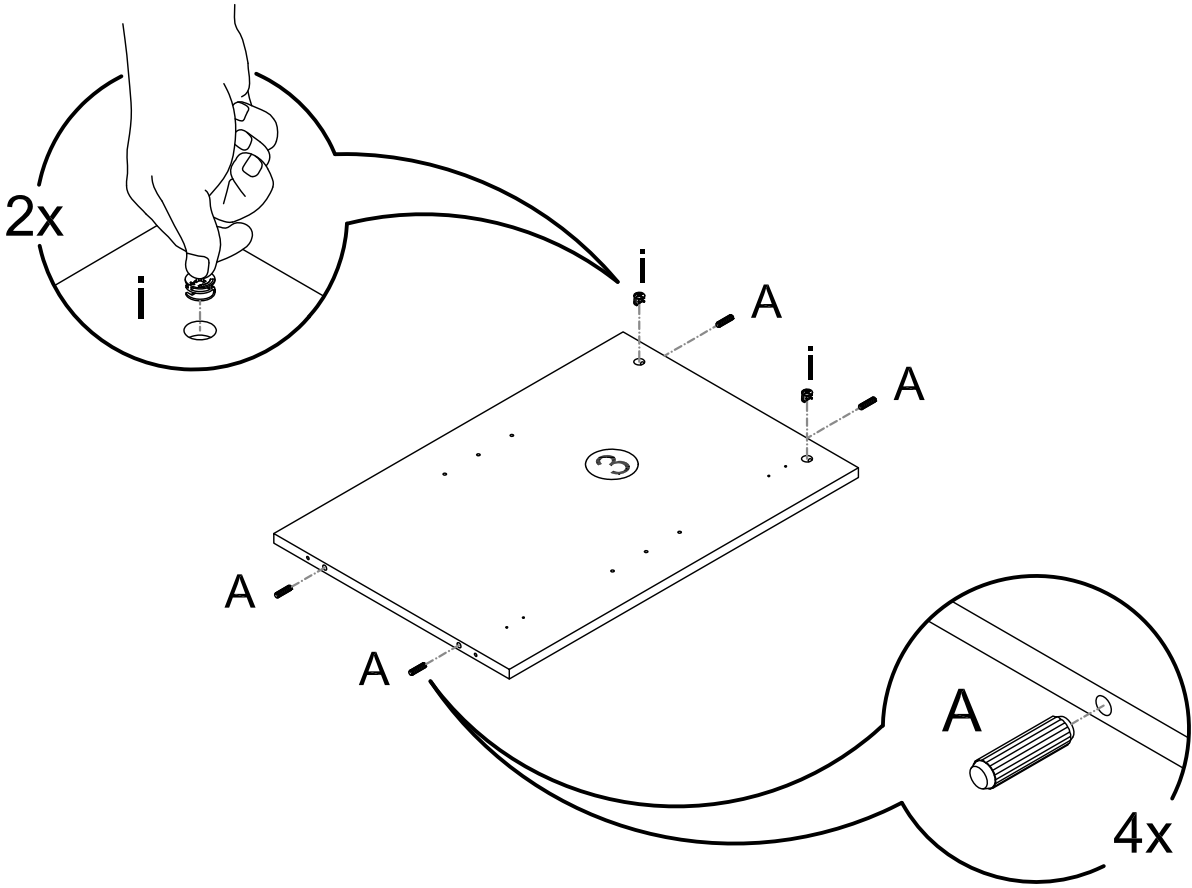
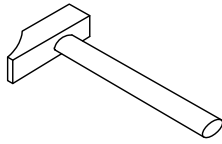

4

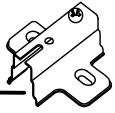

D x2

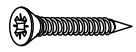

Tb x4

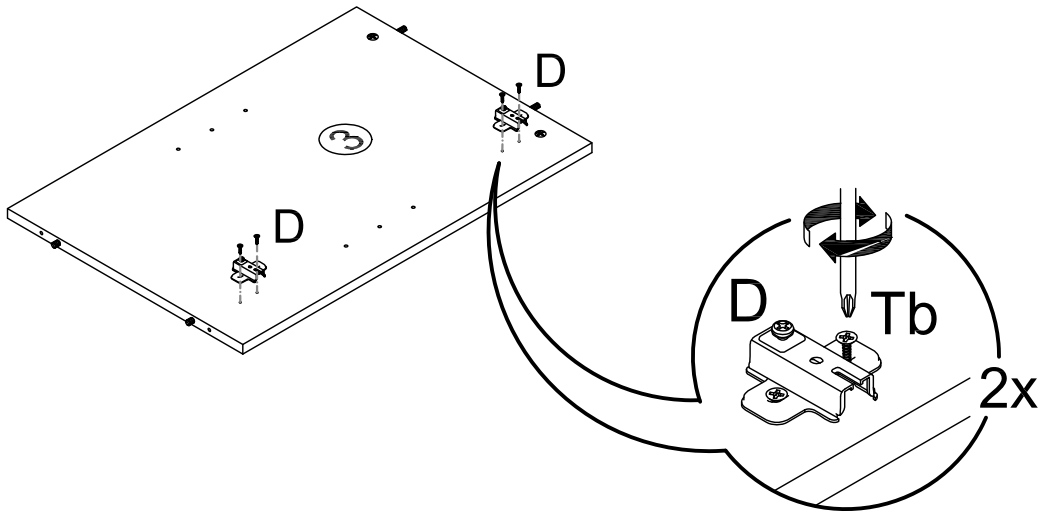
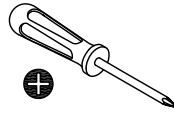

5

A x4 i x2

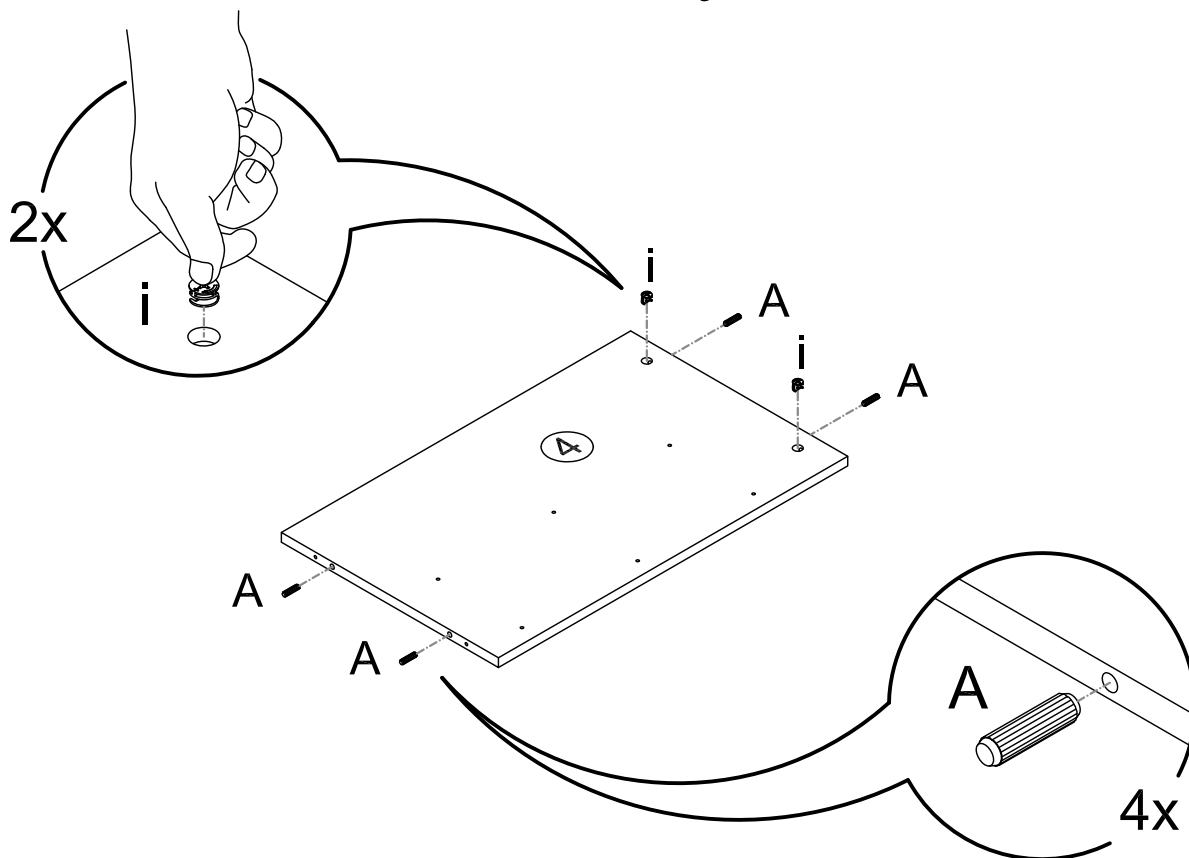
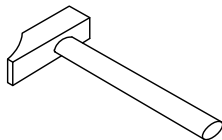

6

A x4 i x2

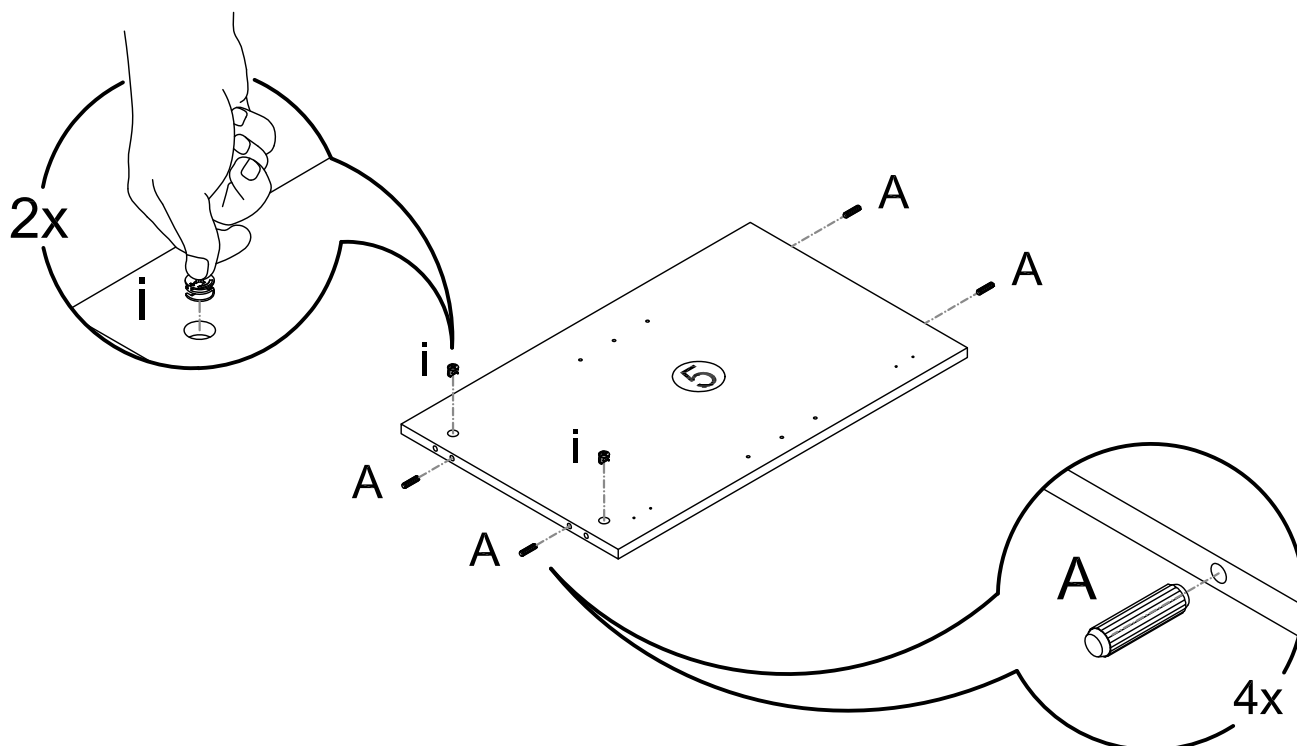
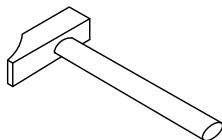

7

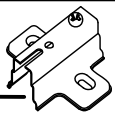

D x2



Tb x4

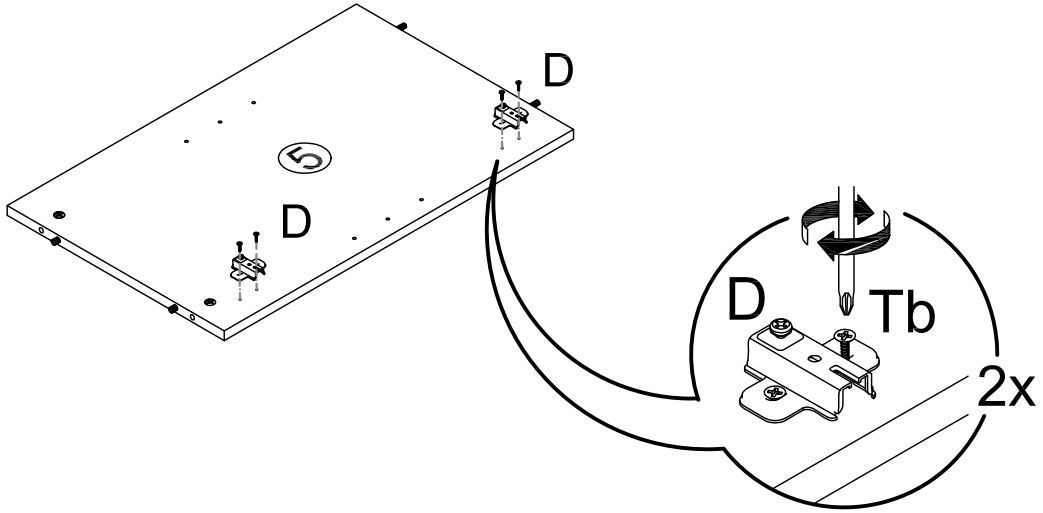
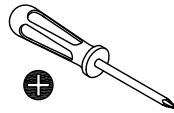

8

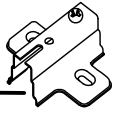

D x2



Tb x4

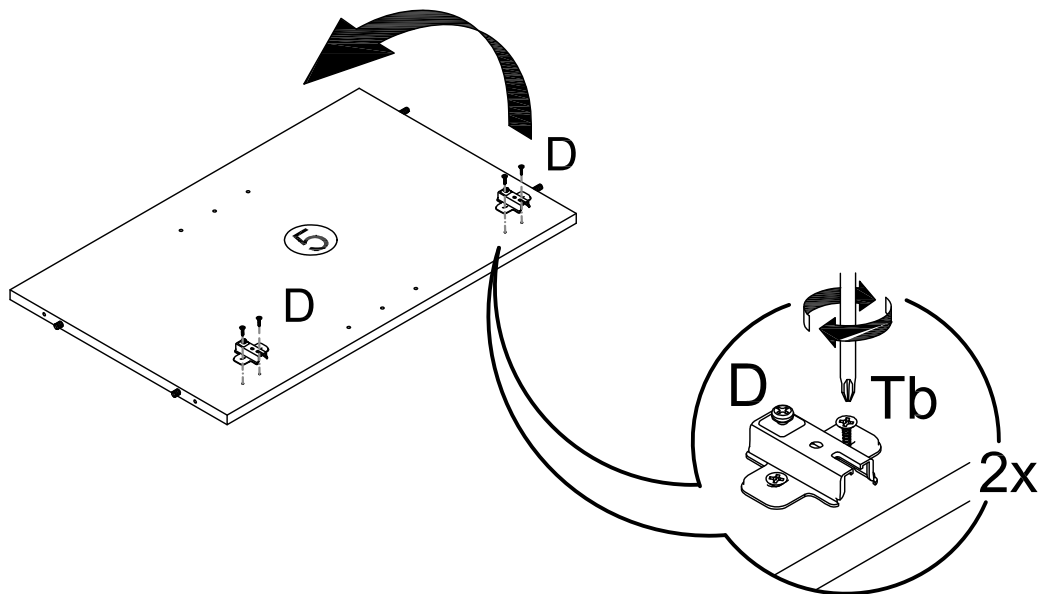
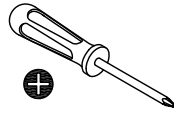

9

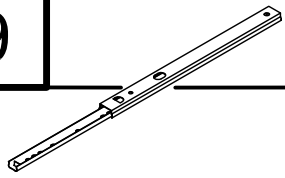

M x6



Tf x12

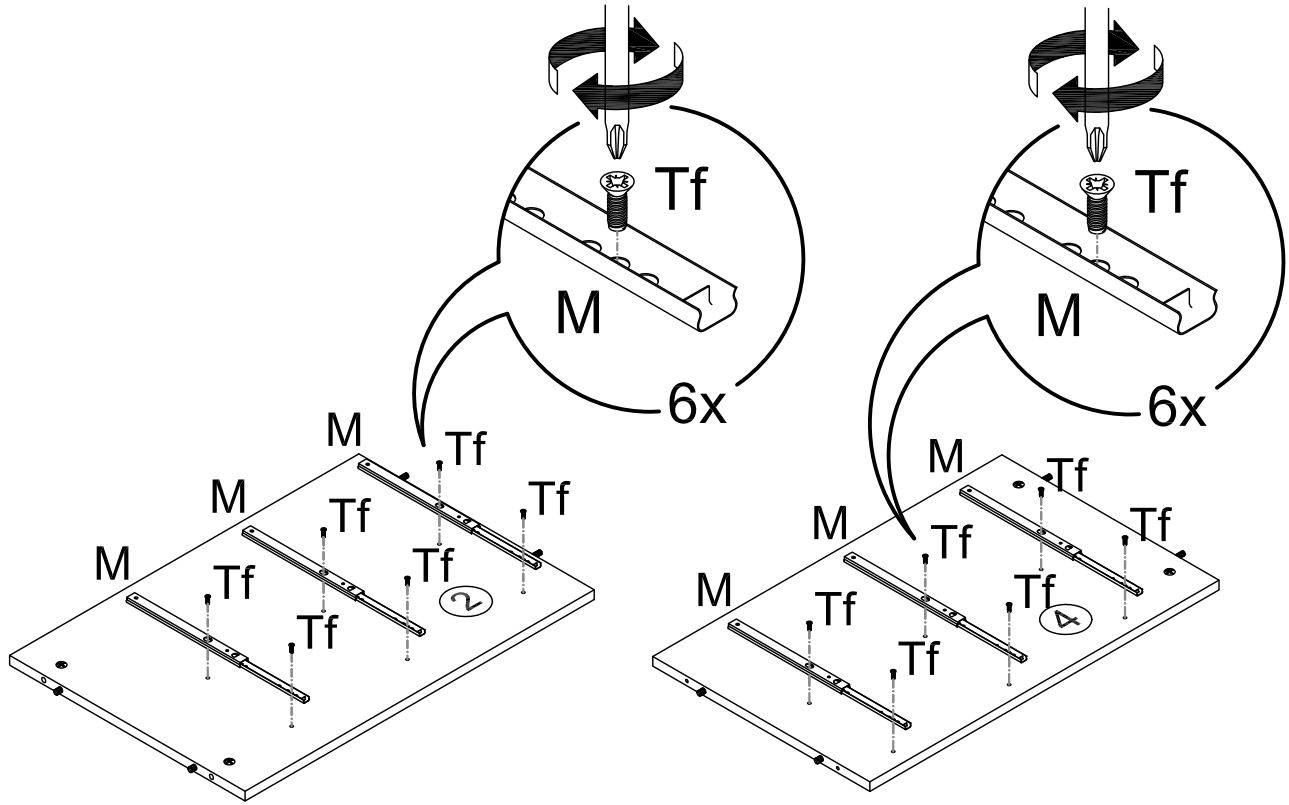
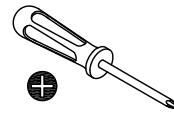

10

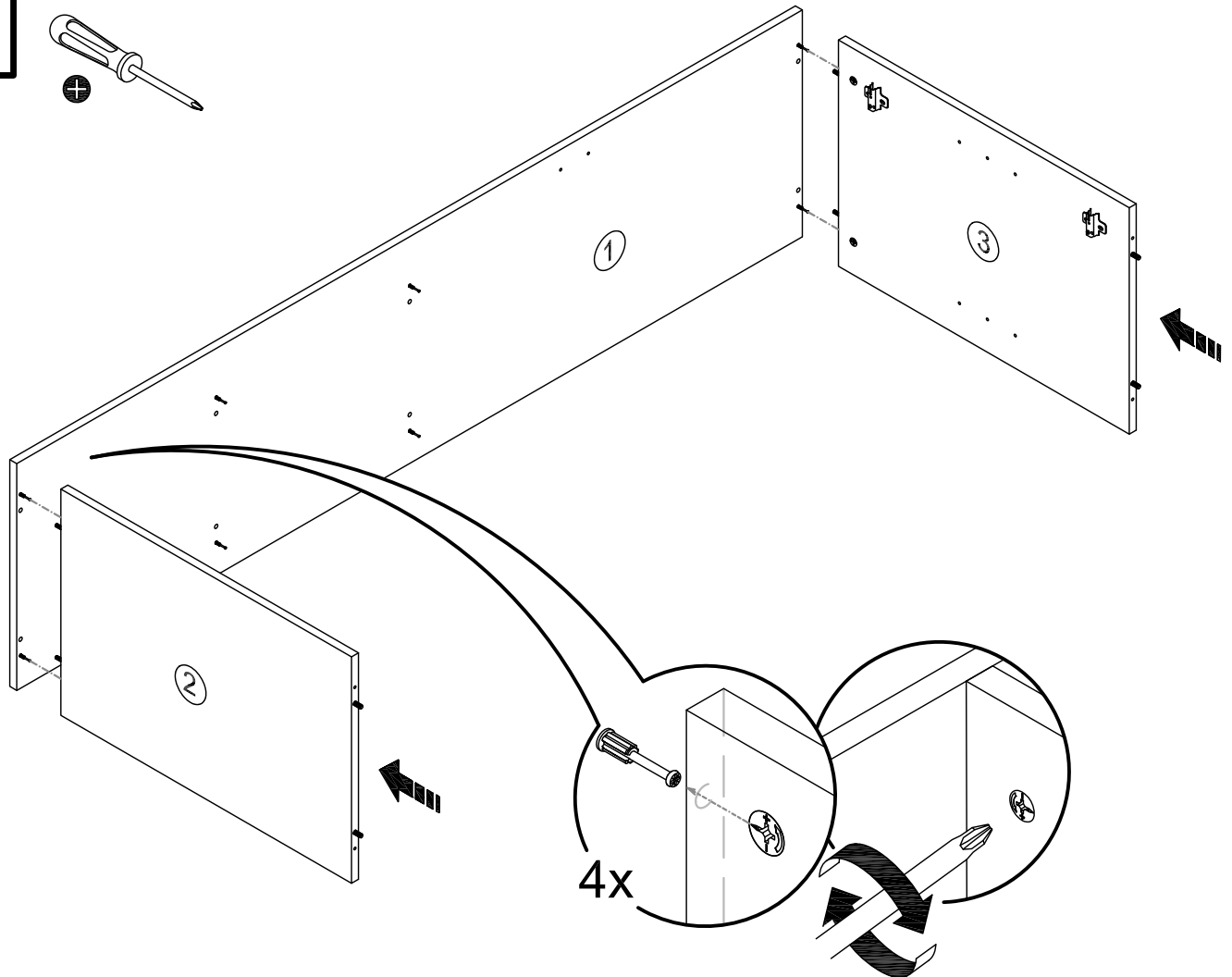
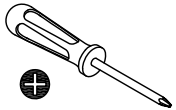



11

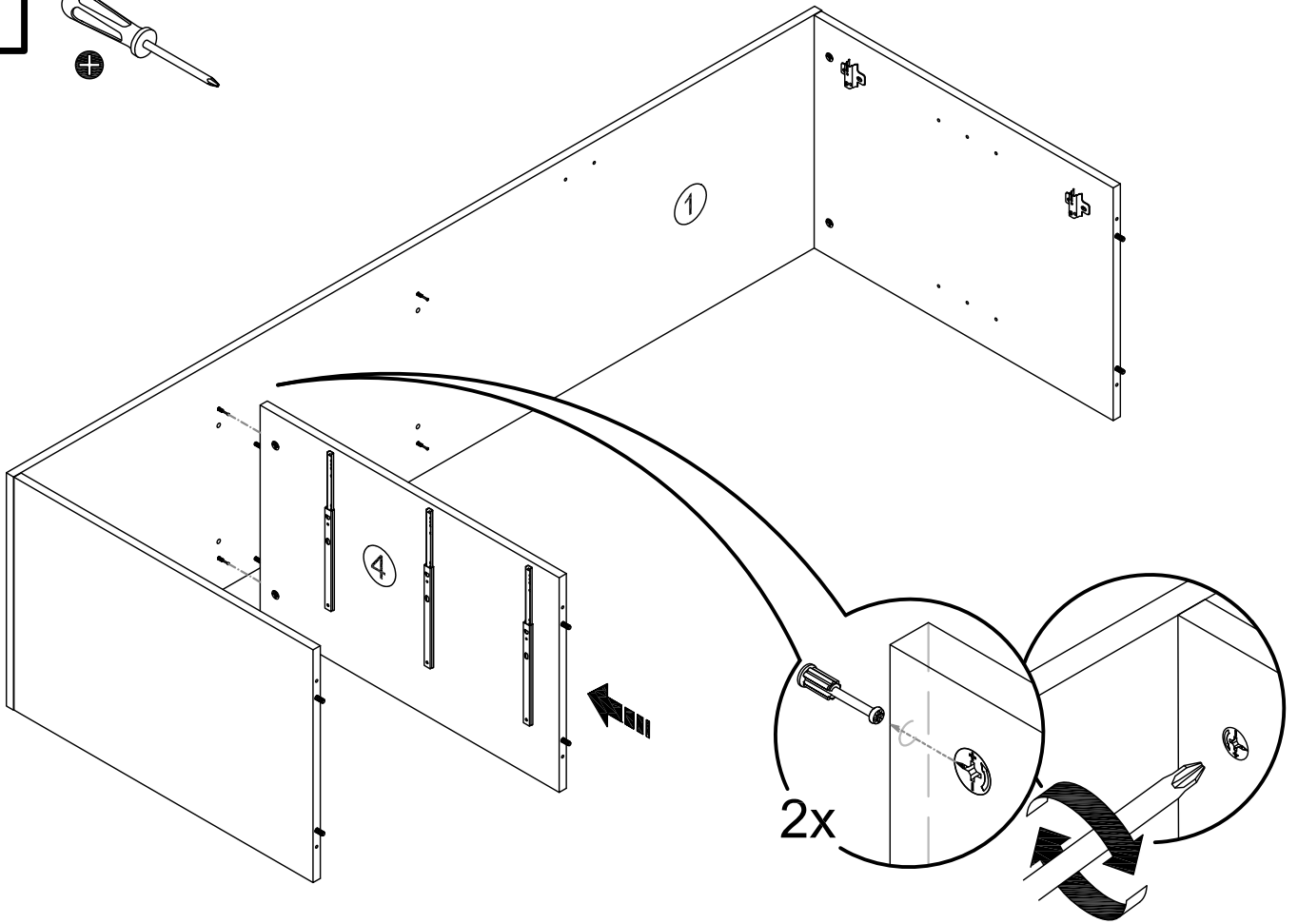
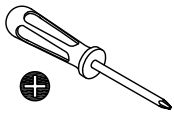

12

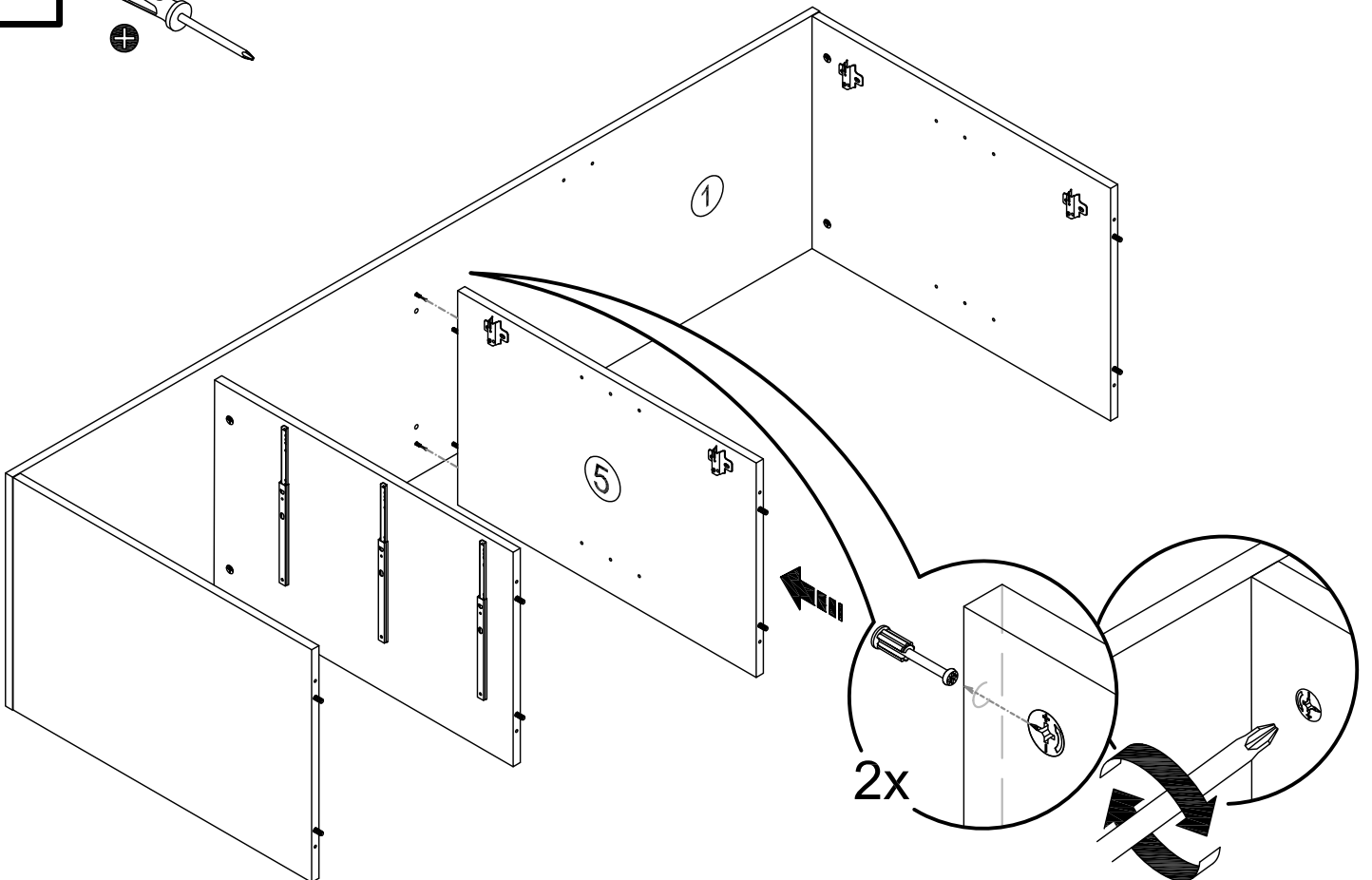
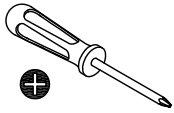

13

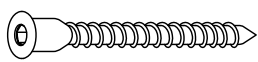

Ta x8

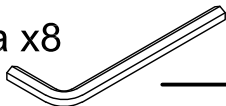

K x1

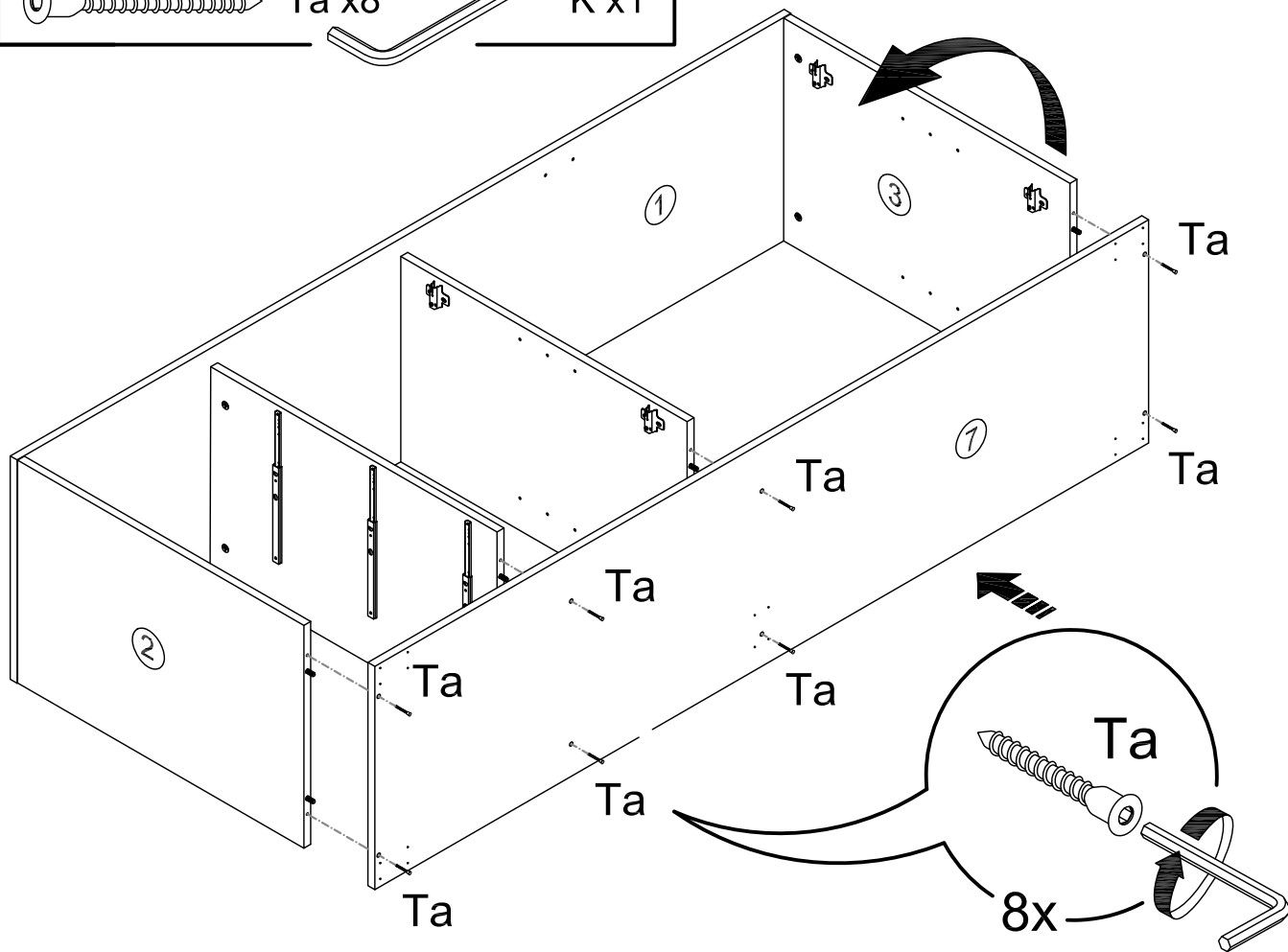

14

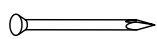

Tc x60

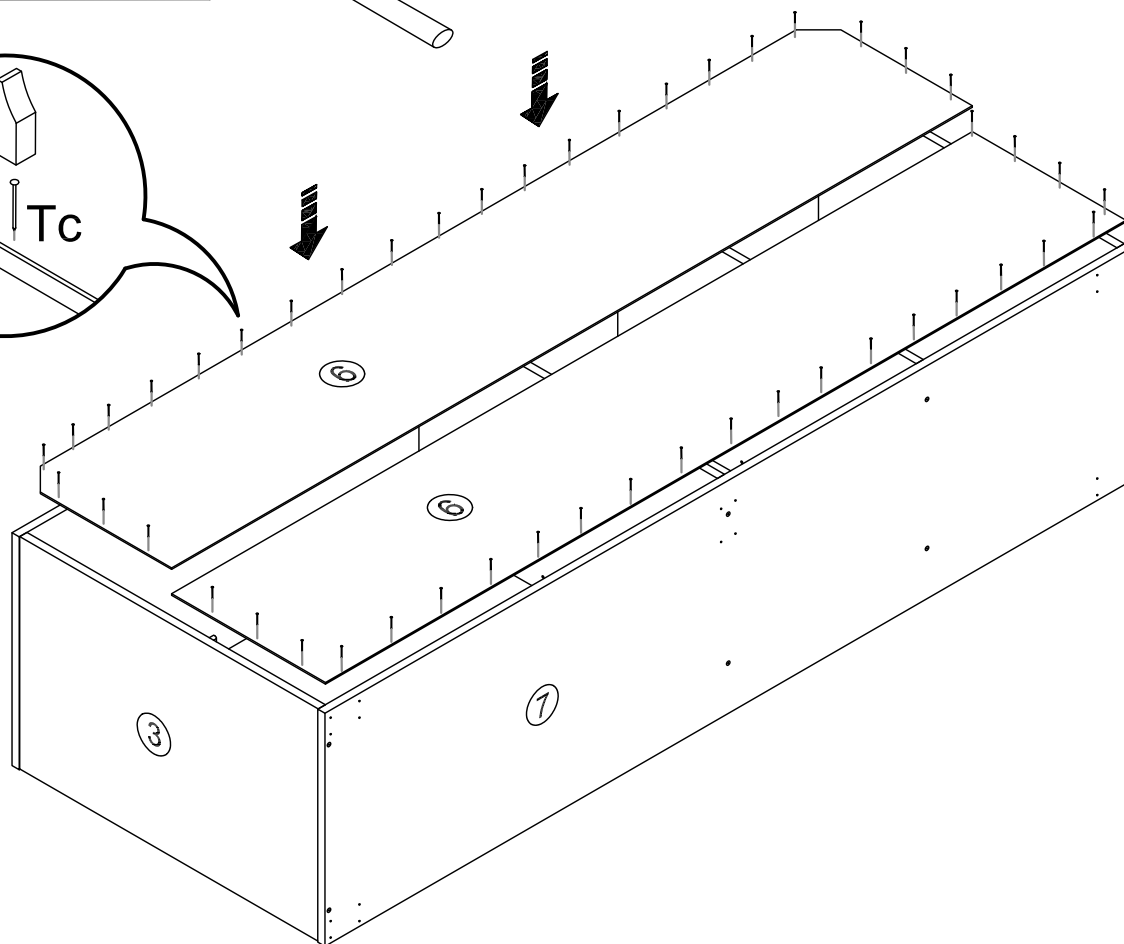
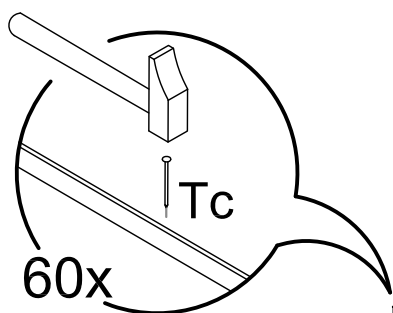
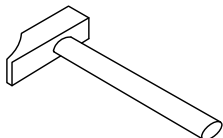

15

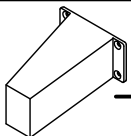

E x5



Tb x20

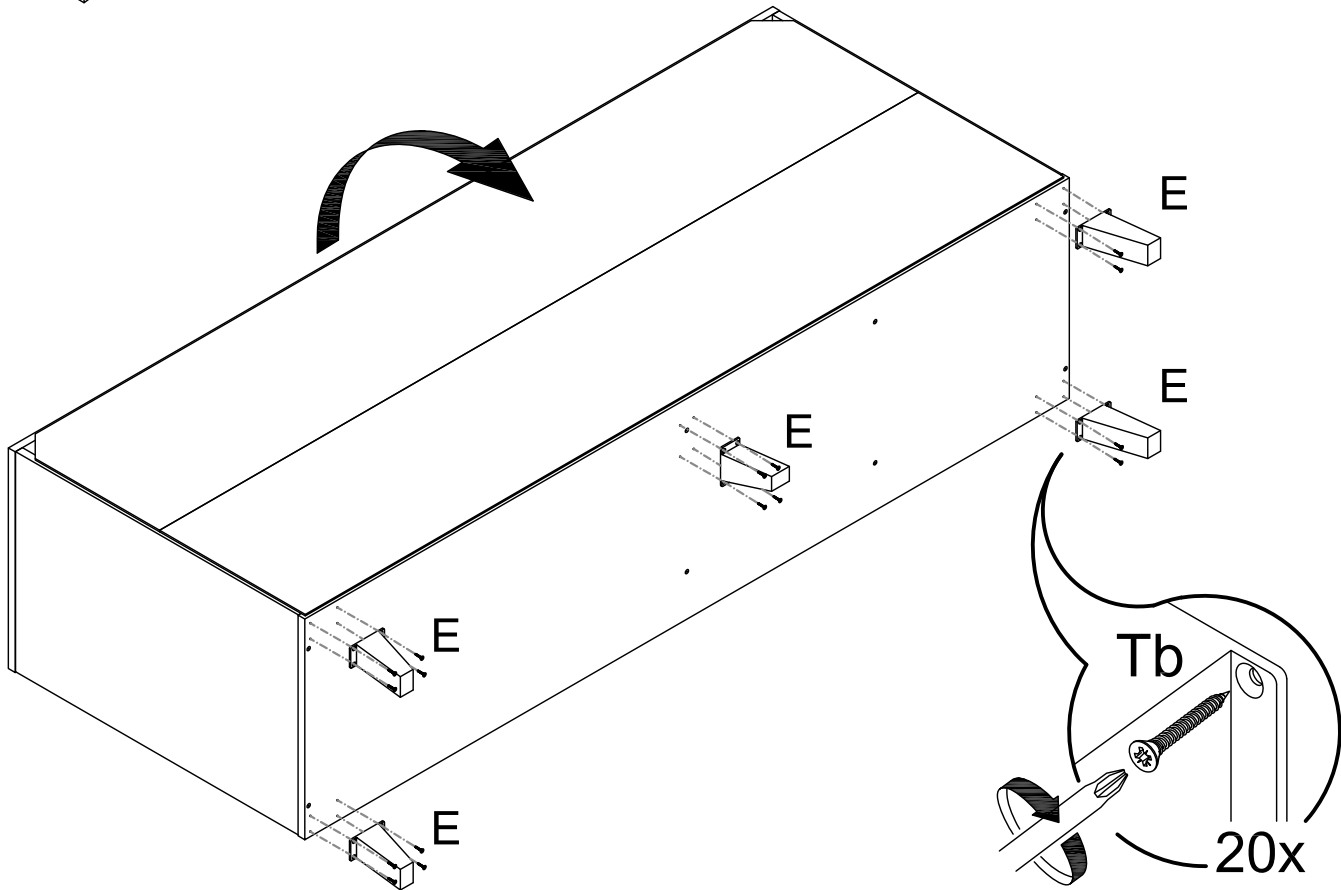
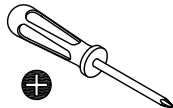

16

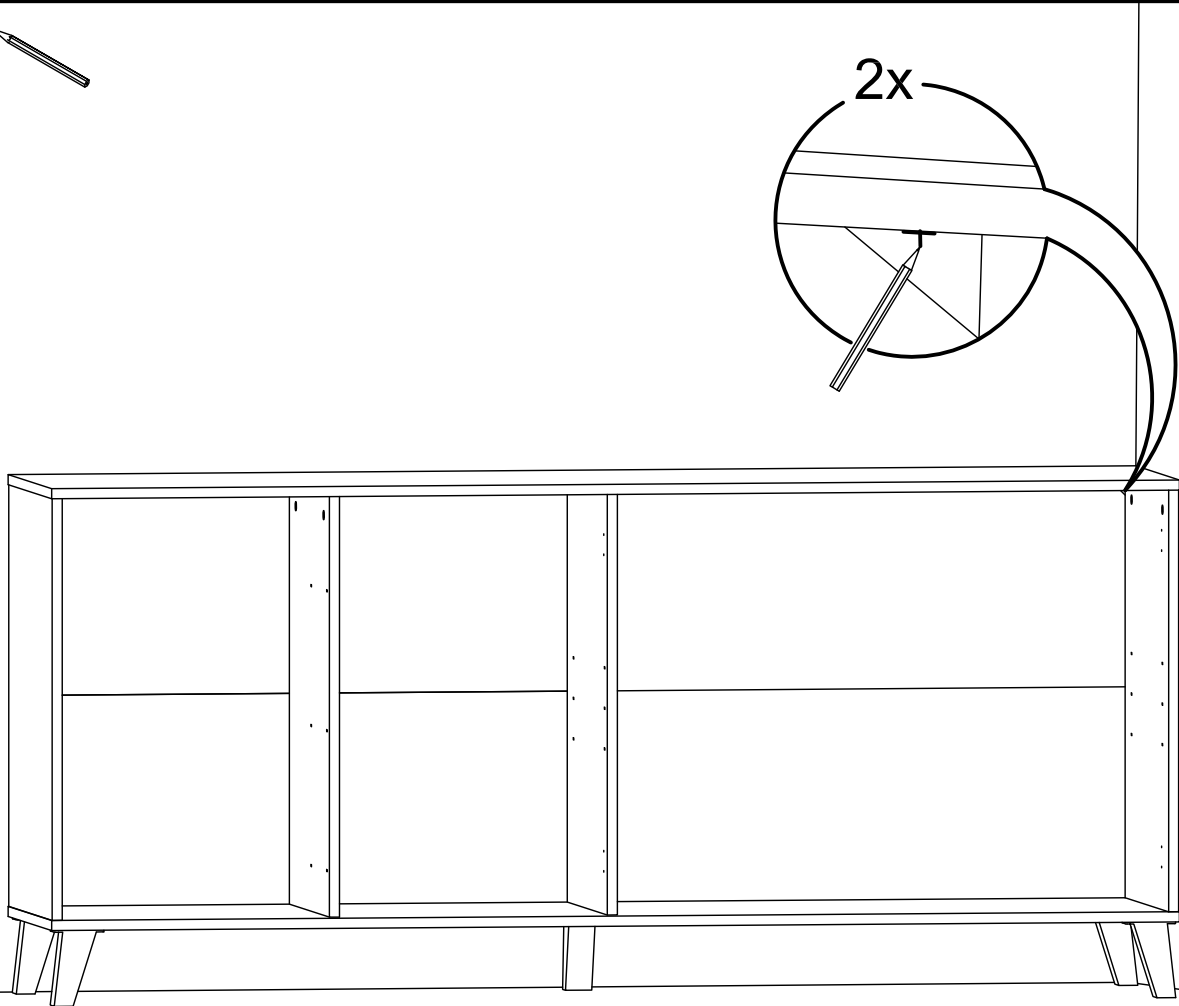

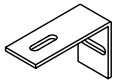

J x2



Tb x2

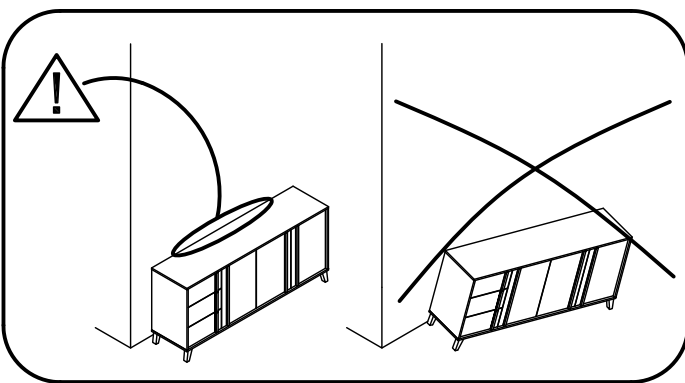
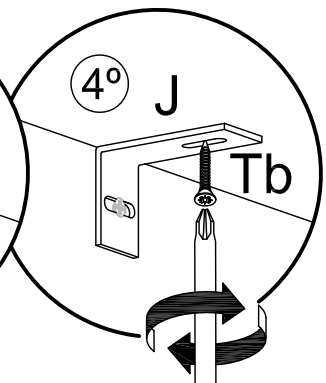
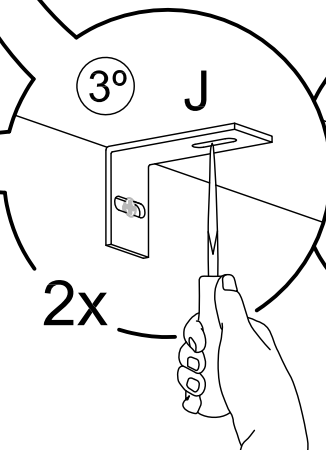
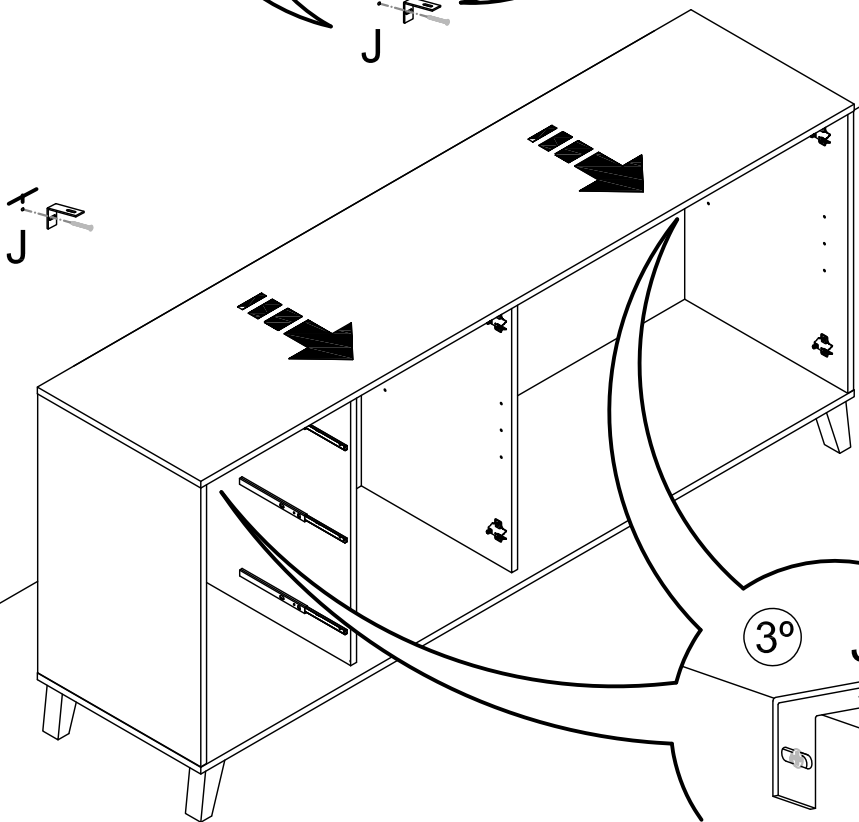
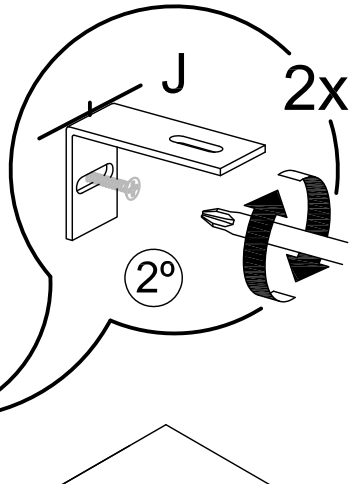
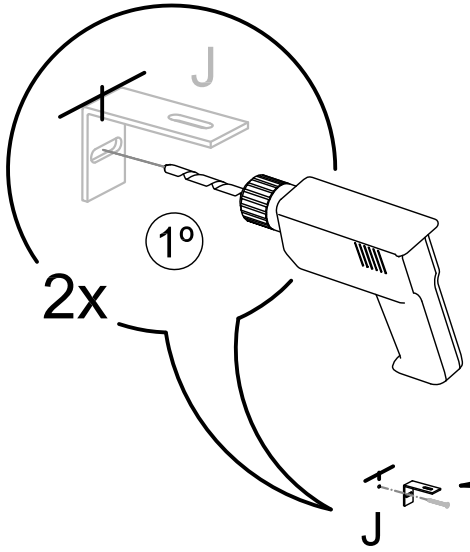
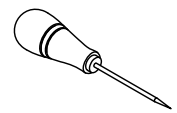
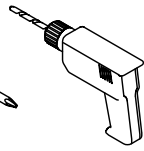
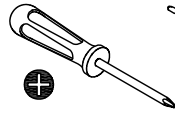

- !**
- FR - FIXATION MURALE OBLIGATORIE. Utilisez des vis et des chevilles adaptées à vos murs.
  - ES - OBLIGATORIO FIJAR A LA PARED. Utilice los tornillos y tacos adecuados para su muro.
  - EN - OBLIGATORY FIX ON THE WALL. Use screws and plugs suitable for your wall.
  - PT - FIXAÇÃO OBRIGATÓRIA À PAREDE. Use os parafusos e buchas apropriados para sua parede.
  - IT - OBBLIGATORIO DA FISSARE ALLA PARETE. Utilizzare le viti e i tasselli appropriati per il muro.
  - DE - ERFORDERLICH, UM DIE WAND ZU FIXIEREN. Verwenden Sie die entsprechenden Schrauben und Dübel für Ihre Wand.

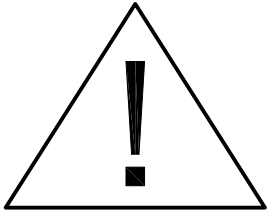

FR - Les vis et chevilles pour la fixation murale ne sont pas incluses car leur choix dépend du matériau du mur sur lequel est fixé le meuble.

EN - Screws and plugs for wall mounting are not included because their choice depends on the material of the wall on which is fixed the cabinet.



Il existe une grande diversité de types de murs ou cloisons, c'est la raison pour laquelle nous ne pouvons pas vous fournir le type exact de fixation. Voici quelques exemples de fixations conseillées pour:



LES MURS PLEINS

CHEVILLE NYLON  
"FISCHER"

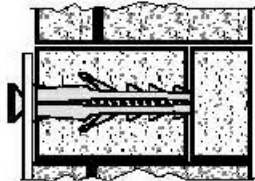
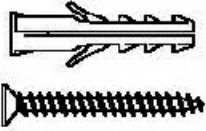

CHEVILLE D'ANCRAGE  
MÉTAL

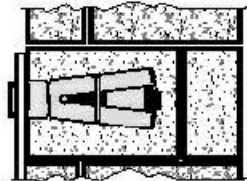
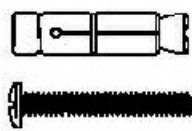

CHEVILLE D'ANCRAGE  
À AILETTES EN NYLON

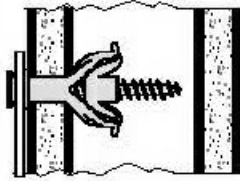
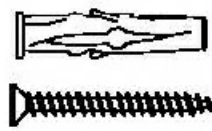

LES CLOISONS CREUSES

CHEVILLE MÉTALLIQUE  
À EXPANSION

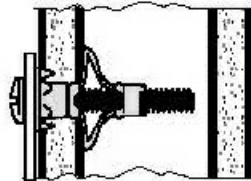
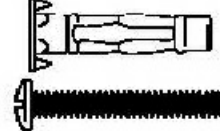

CHEVILLE  
"MOLLY"

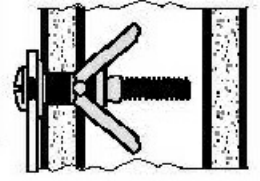
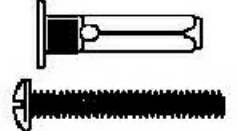

Utiliser une taille de forêt adaptée à la quincaillerie utilisée et au type de mur.



Due to the wide diversity of wall or partition types, we cannot provide you with suitable attachment fixtures. Here are some examples of attachment fixtures recommended for:



BLIND WALLS

"FISCHER"  
NYLON PLUG

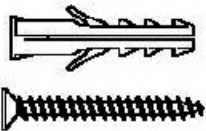

METAL  
WALL PLUG

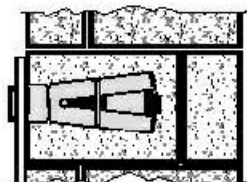
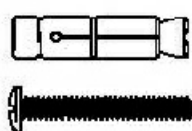

NYLON WINGED  
WALL PLUG

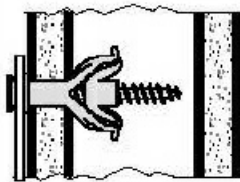
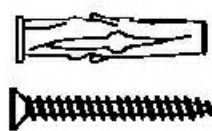

STUDDED WALLS  
METAL EXPANSION  
PLUG

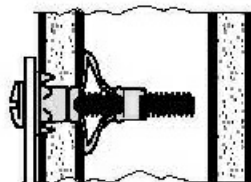
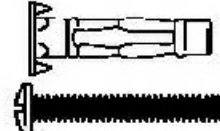

"MOLLY"  
PLUG

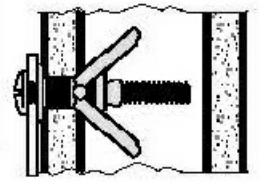
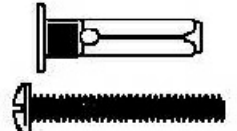

Use a drill bit that is compatible in size with the hardware used and the type of wall.

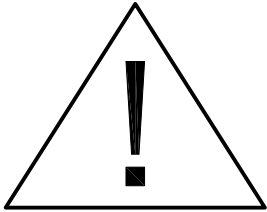

IT - Le viti e tasselli per il montaggio non sono compresi perché la sua elezione dipende dal materiale della parete nella quale si fissa il mobile.

DE - Die Schrauben und die Taco für die Versammlung werden nicht eingeschlossen, weil ihre Wahl vom Material der Mauer abhängt, in dem das Möbelstück merkt.



Esiste una gran varietà di tipi di muri o paratie e noi non siamo in grado di fornirvi il tipo esatto di fissaggio per ognuno di essi. Ecco qualche esempio di fissaggi consigliati per:



I MURI PIENI

TASSELLO NYLON  
"FISCHER"

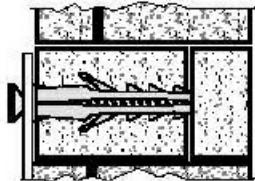
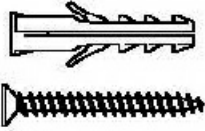

TASSELLO DI ANCORAGGIO  
IN METALLO

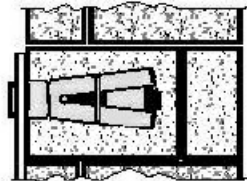
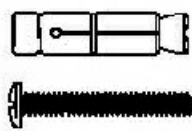

TASSELLO DI ANCORAGGIO AD  
ALETTE IN NYLON

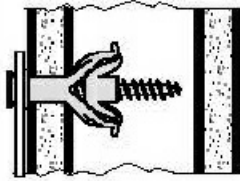
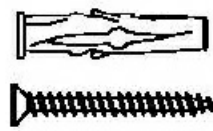

PARATIE CAVE

TASSELLO METALLICO  
AD ESPANSIONE

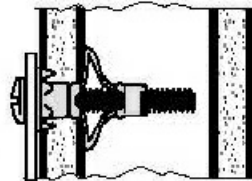
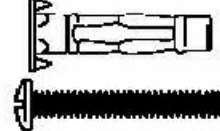

TASSELLO  
"MOLLY"

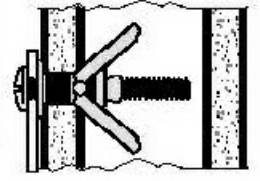
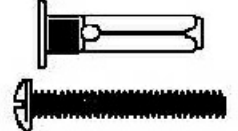

Utilizzare una punta di trapano adatta agli utensili utilizzati e al tipo di muro.



Es gibt eine Vielzahl verschiedener Arten von Mauern oder Zwischenwänden, und aus diesem Grunde können wir Ihnen den genau entsprechenden Befestigungstyp nicht bereitstellen. Nachfolgend einige Beispiele empfohlener Befestigungen für:



VOLLWÄNDE

NYLONDÜBEL  
"FISCHER"

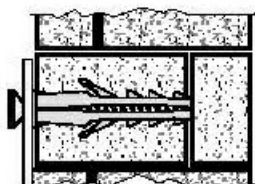
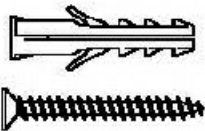

ANKERDÜBEL  
AUS METALL

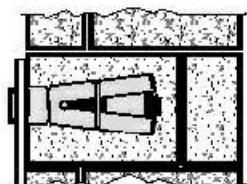
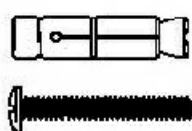

ANKERDÜBEL MIT  
NYLONFLÜGELN

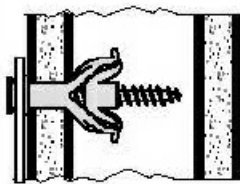
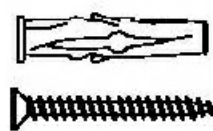

HOHLWÄNDE

SPREIZDÜBEL FÜR  
VERANKERUNG AUS METALL

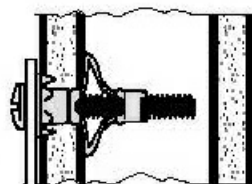
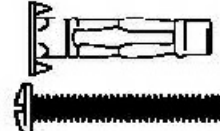

DÜBEL  
"MOLLY"

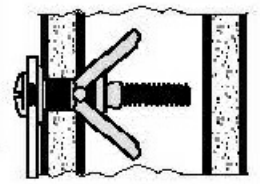
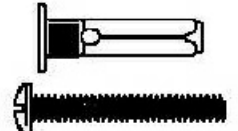

Bitte verwenden Sie eine für die Eisenwaren und den Wandtyp geeignete Bohrergroße.

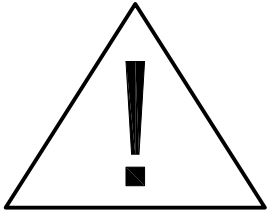

ES - Los tornillos y tacos para montaje en pared no están incluidos porque su elección depende del material de la pared en la que se fija el mueble.

PT - Os parafusos e buchas para montagem na parede não estão incluídos porque sua escolha depende do material da parede em que o móvel é fixo.



Existe una gran variedad de tipos de muros y paredes y no podemos proporcionarle el tipo exacto de fijación para cada uno. Aquí hay algunos ejemplos de fijaciones recomendadas para:



PARED MACIZA

TACO DE NYLON  
"FISCHER"

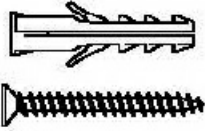

TACO DE ANCLAJE  
METÁLICO

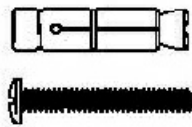

TACO DE ANCLAJE CON  
ALETAS DE NYLON

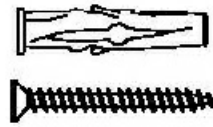

PARED HUECA  
TACO METÁLICO  
DE EXPANSIÓN

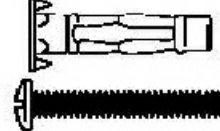

TACO  
"MOLLY"

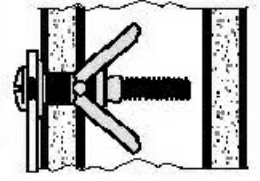
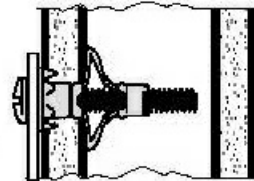
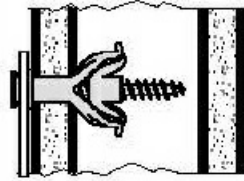
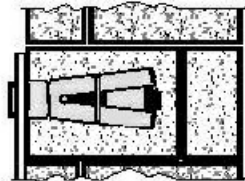
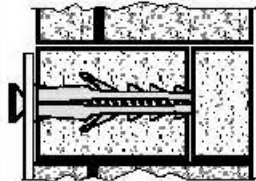
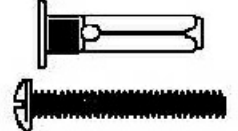

Use una broca adecuada para las herramientas utilizadas y el tipo de pared.



Existe uma grande variedade de tipos de paredes ou anteparas e não podemos fornecer o tipo exato de fixação para cada um. Aqui estão alguns exemplos de fixações recomendadas para:



PAREDES SÓLIDAS

BUCHA NYLON  
"FISCHER"

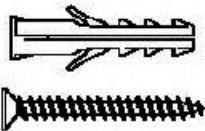

BUCHA ANCORAGEM  
METÁLICA

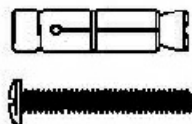

BUCHA ANCORAGEM  
COM ALETA NYLON

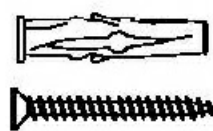

PAREDE OCA  
BUCHA DE EXPANSÃO  
METÁLICA

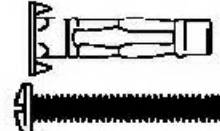

BUCHA  
"MOLLY"

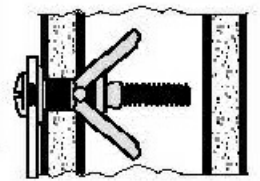
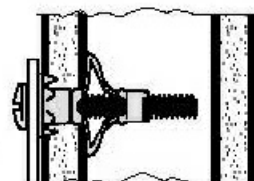
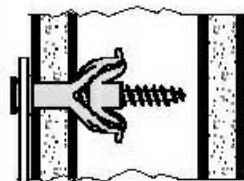
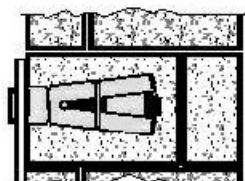
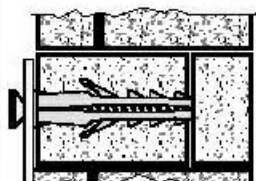
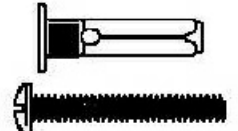

Use uma broca adequada para as ferramentas utilizadas e o tipo de parede.

18

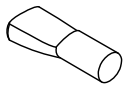

F x8



G x2

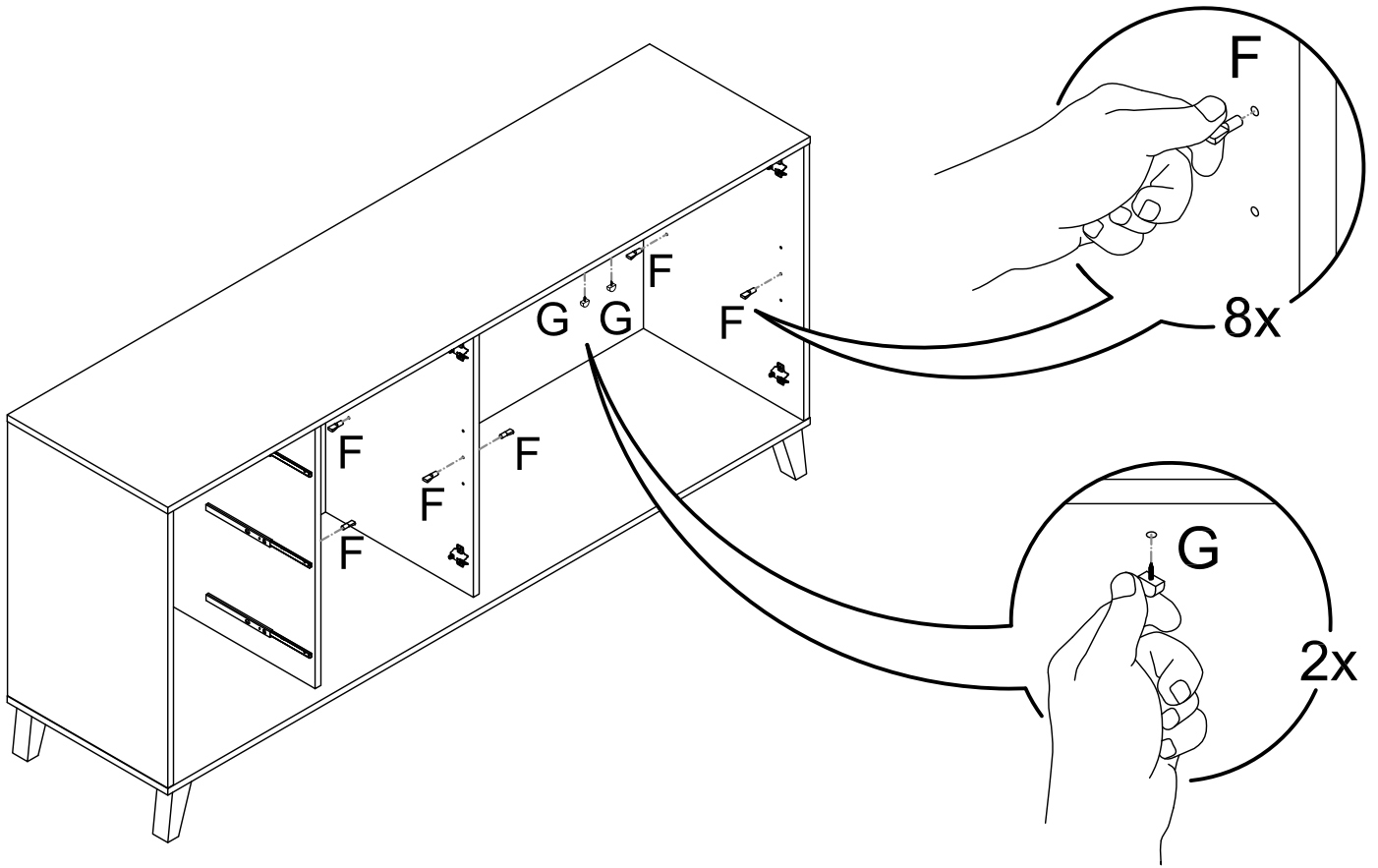

19

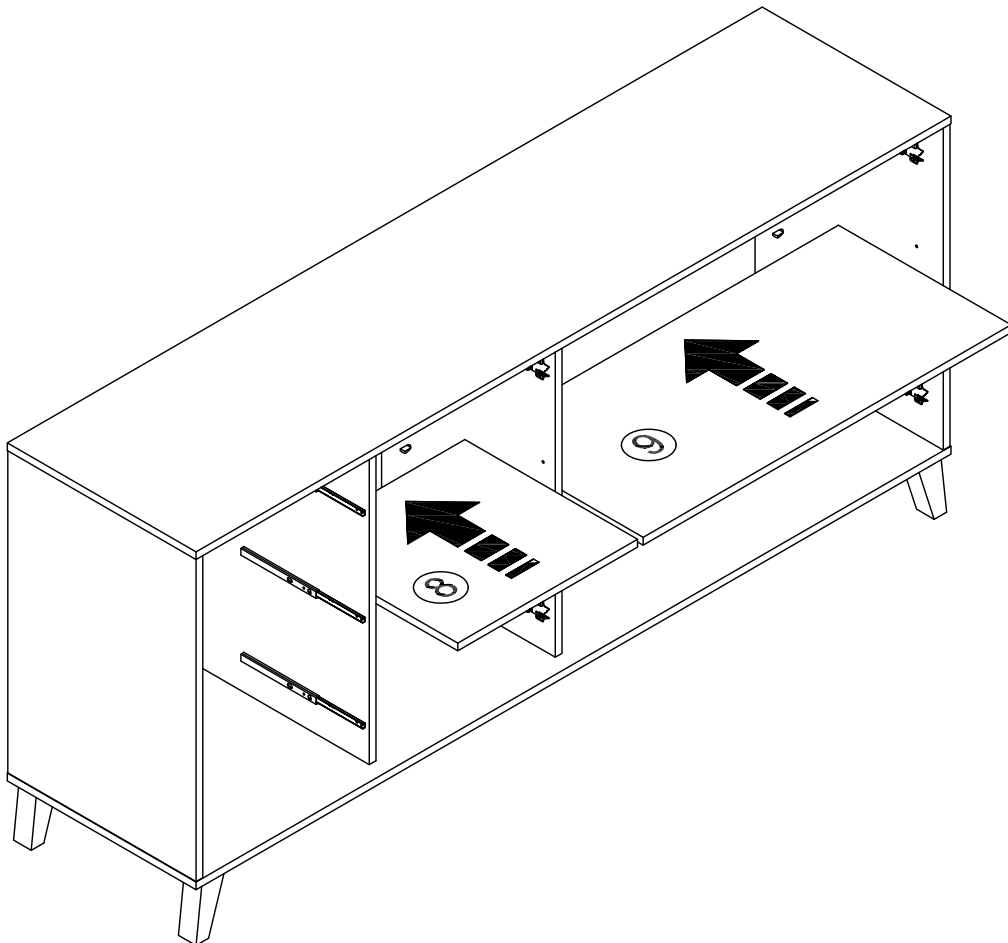



20



H x6



B x6

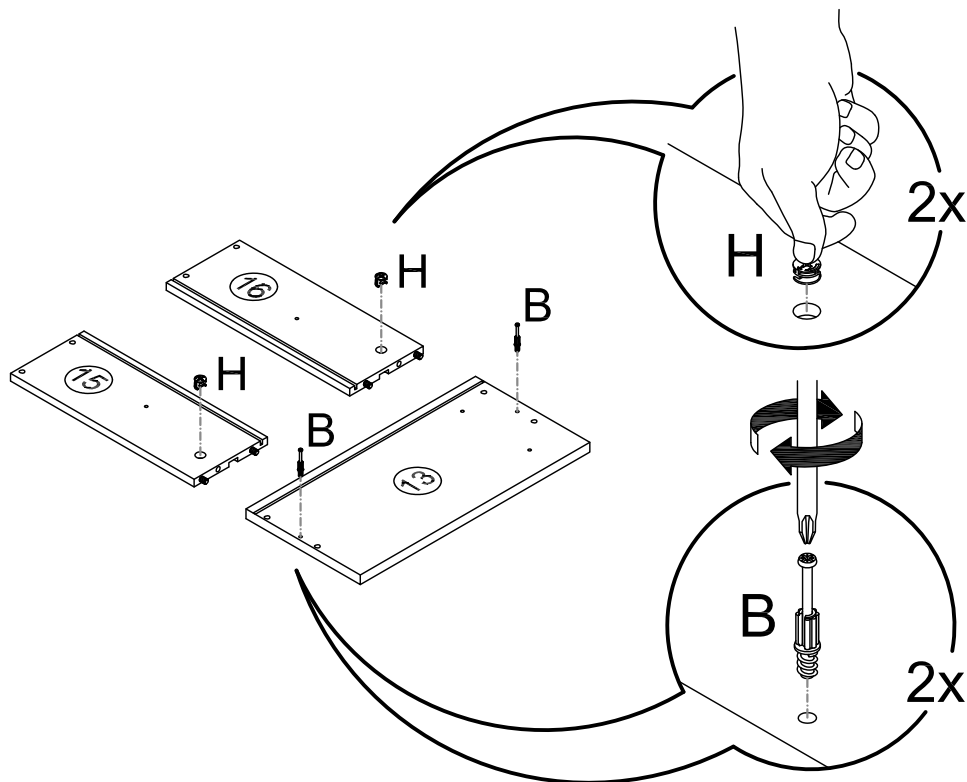
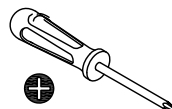

3x

21

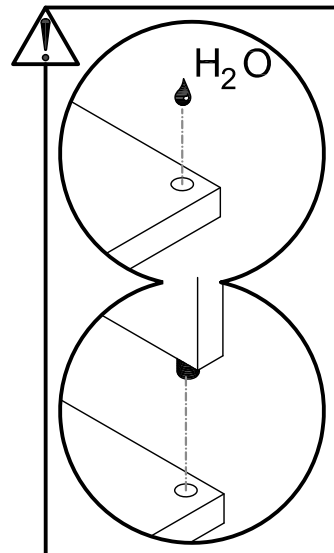
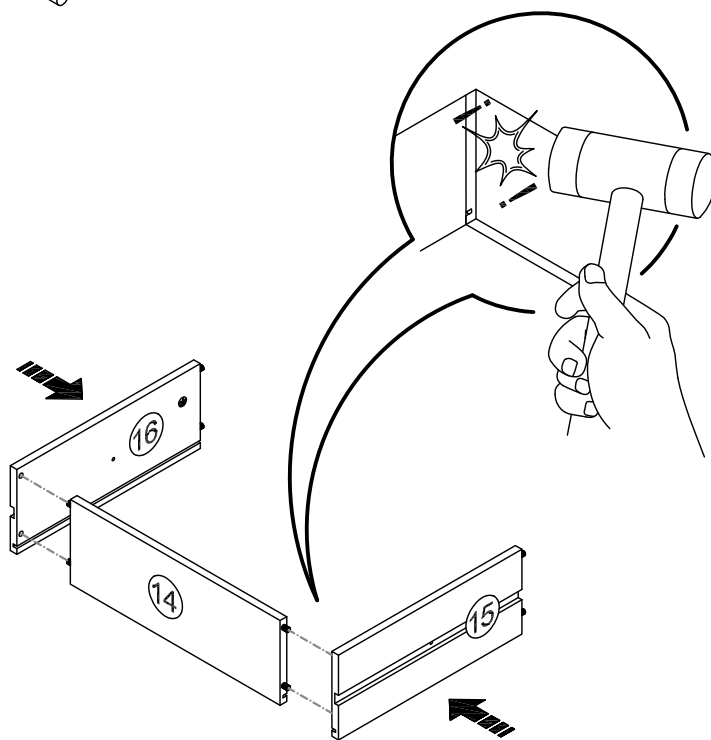
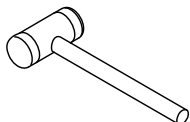

3x

22

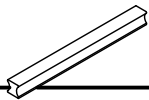

L1 x3



Td x6

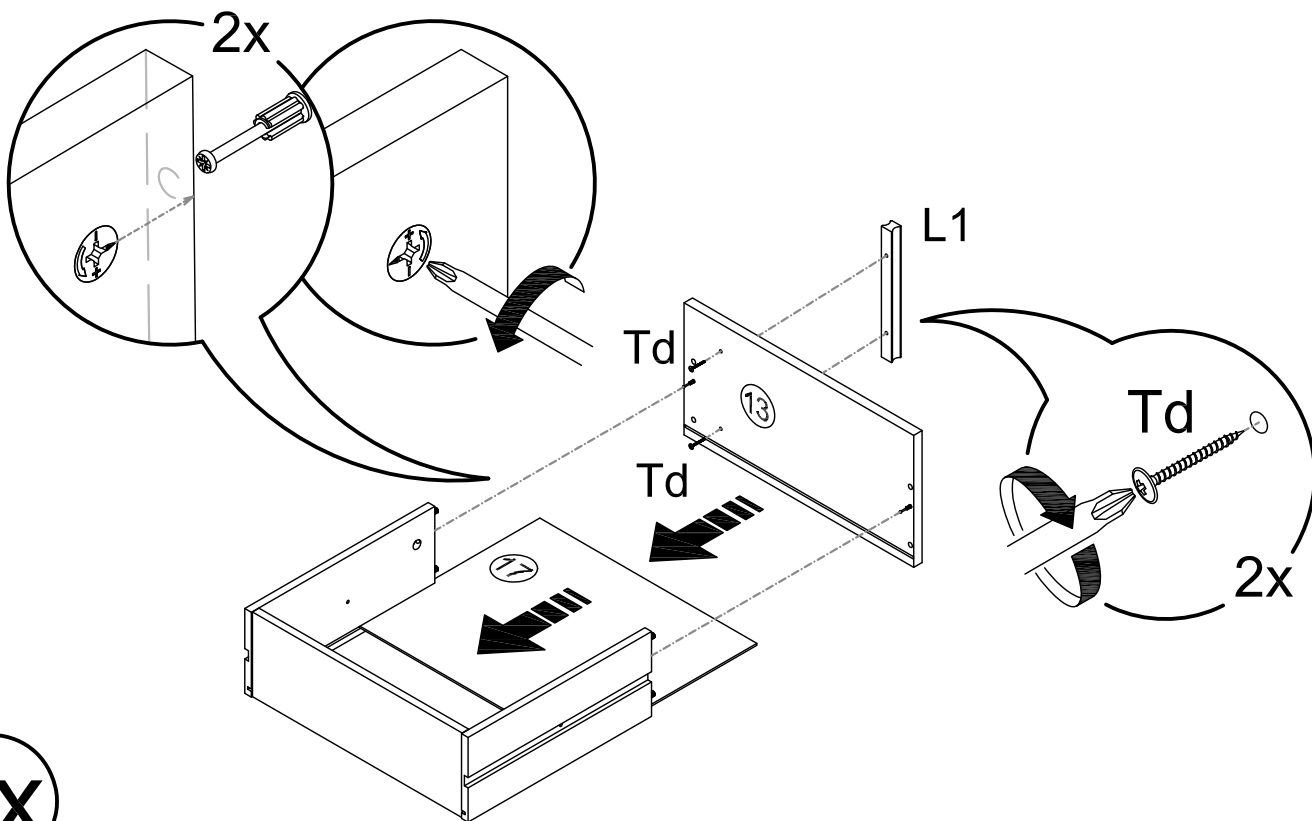
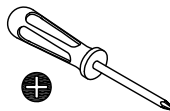

3x

23



Te x6

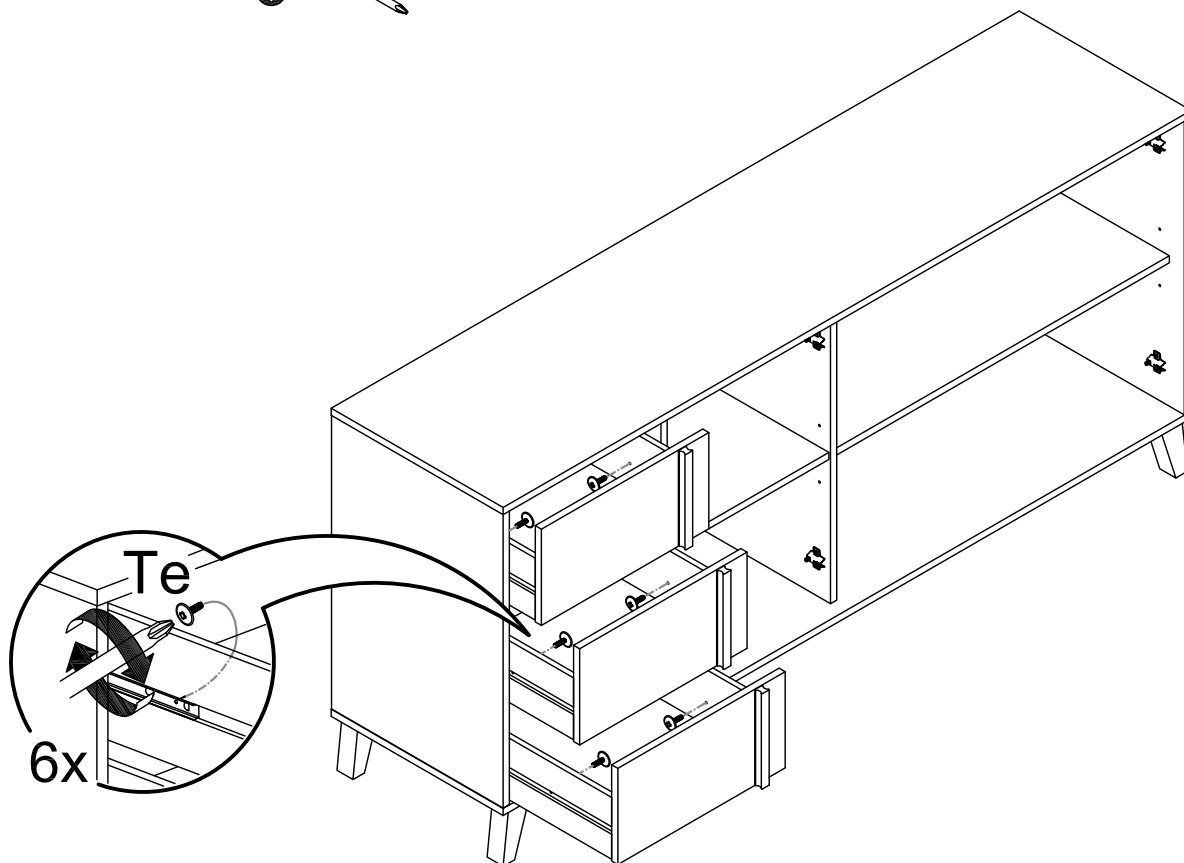
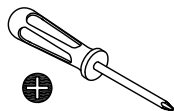

6x

24

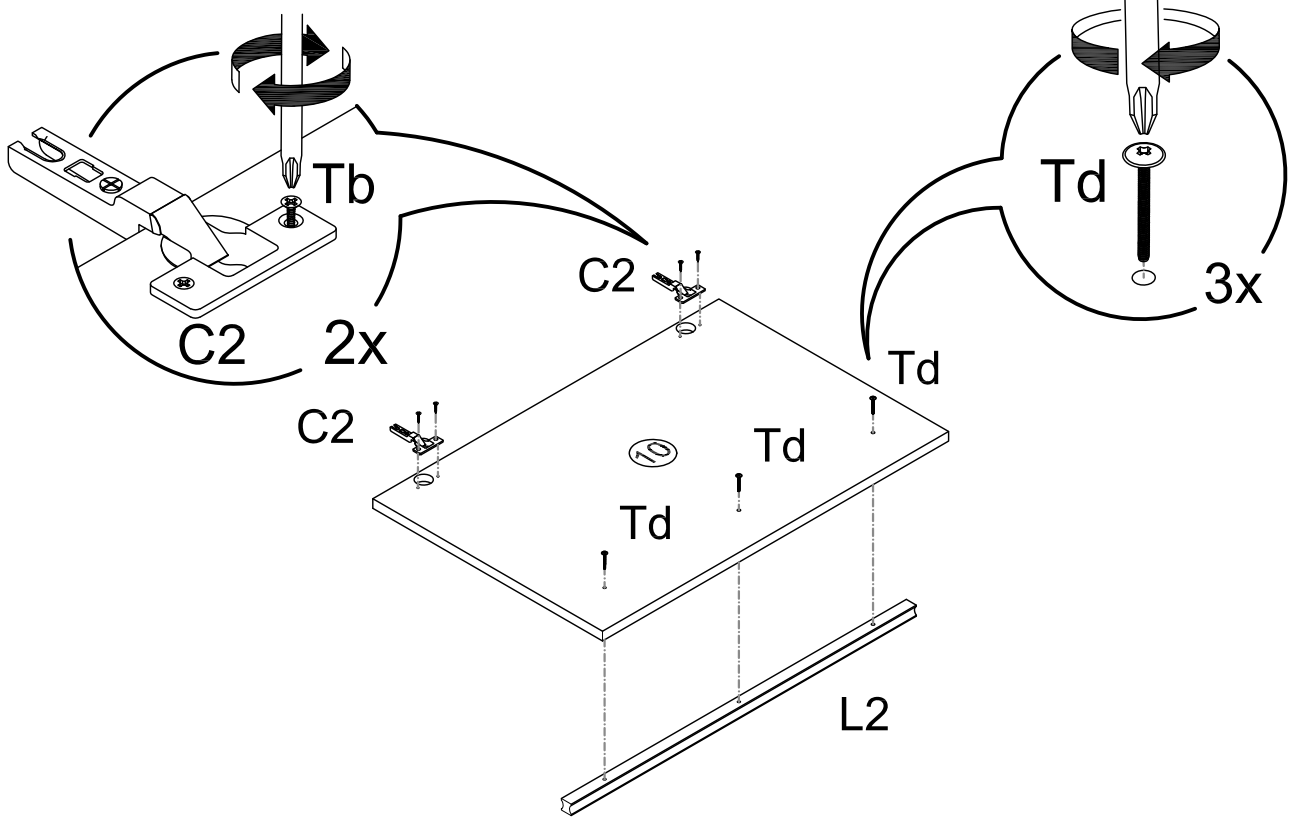
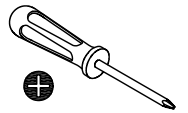
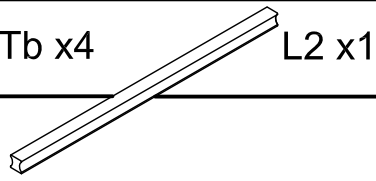
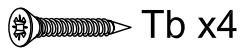
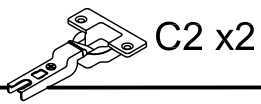

25

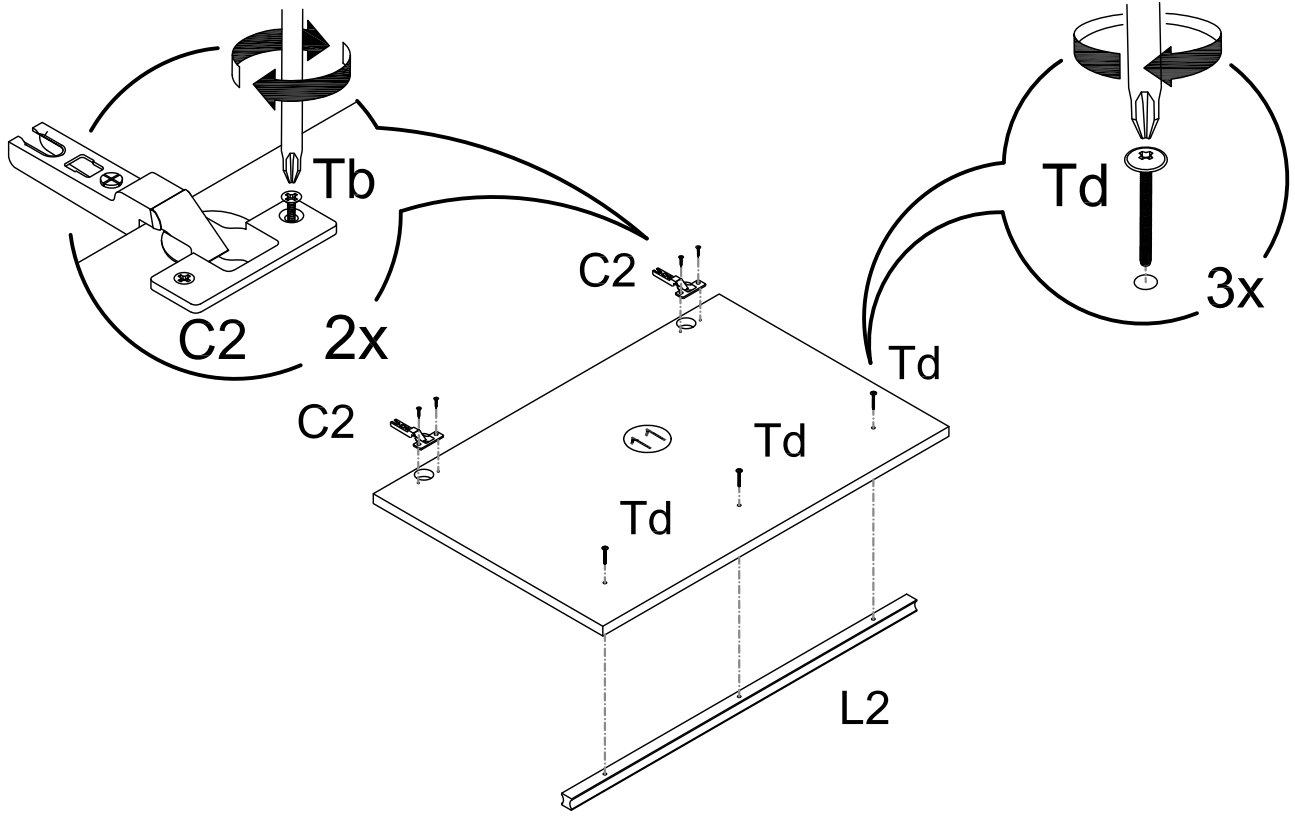
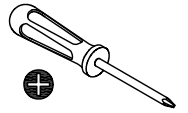
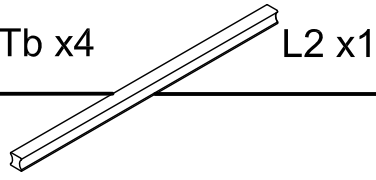
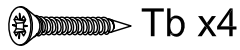
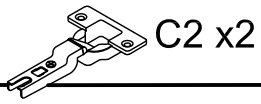

26

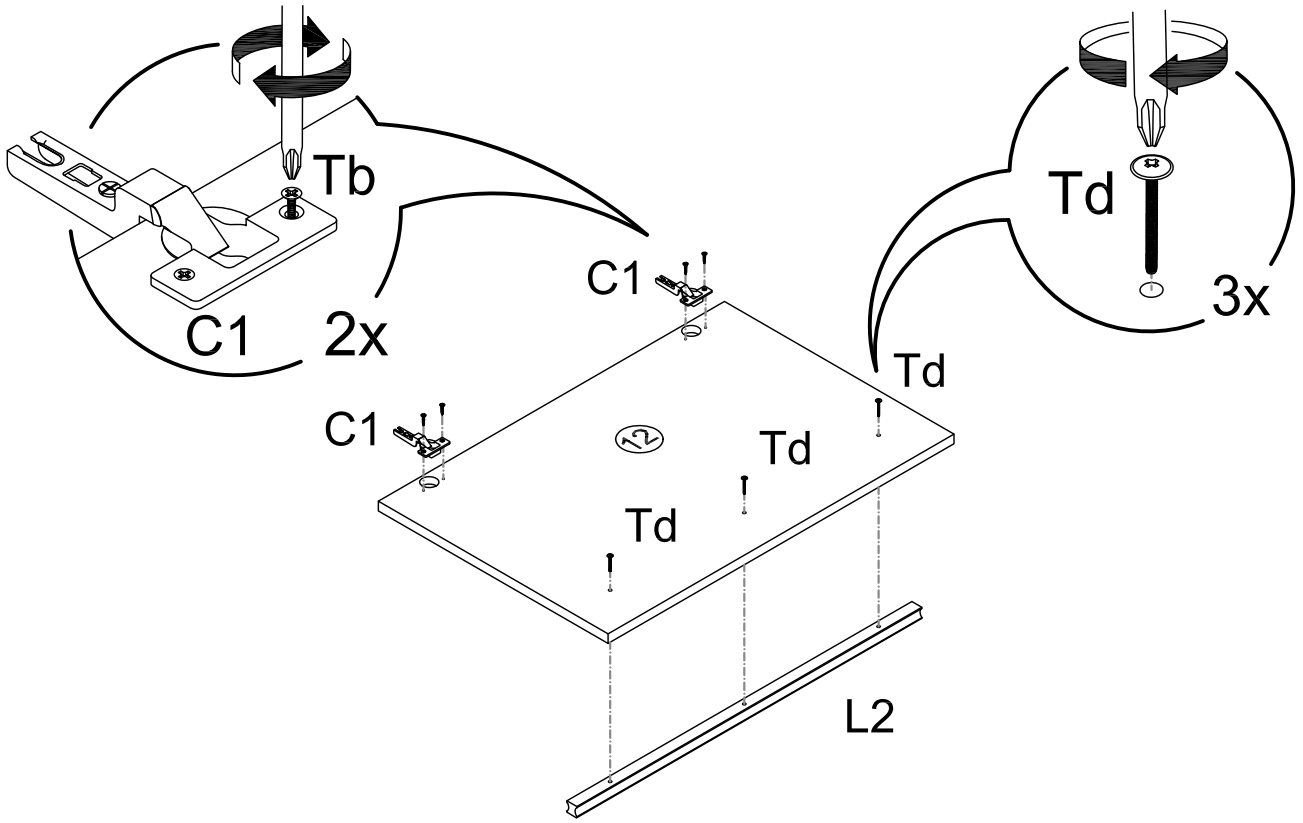
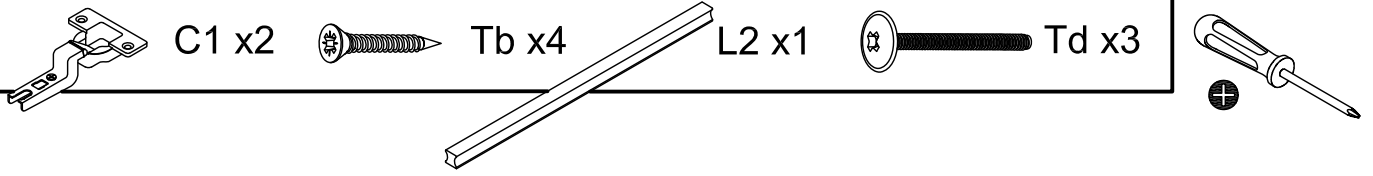

27

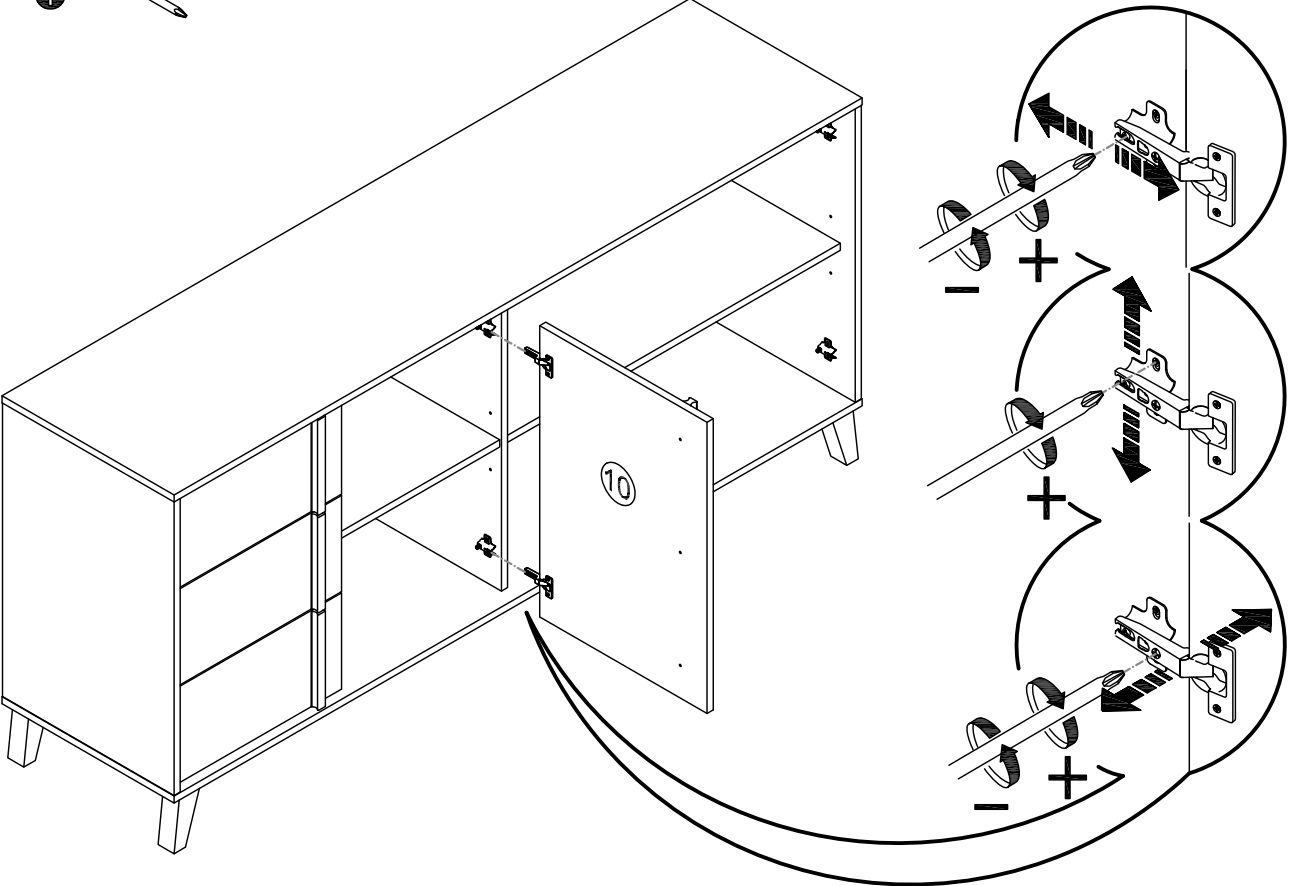
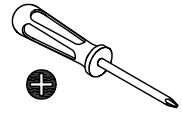

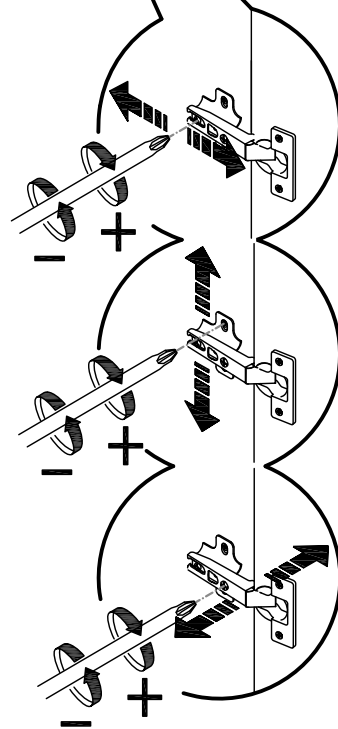
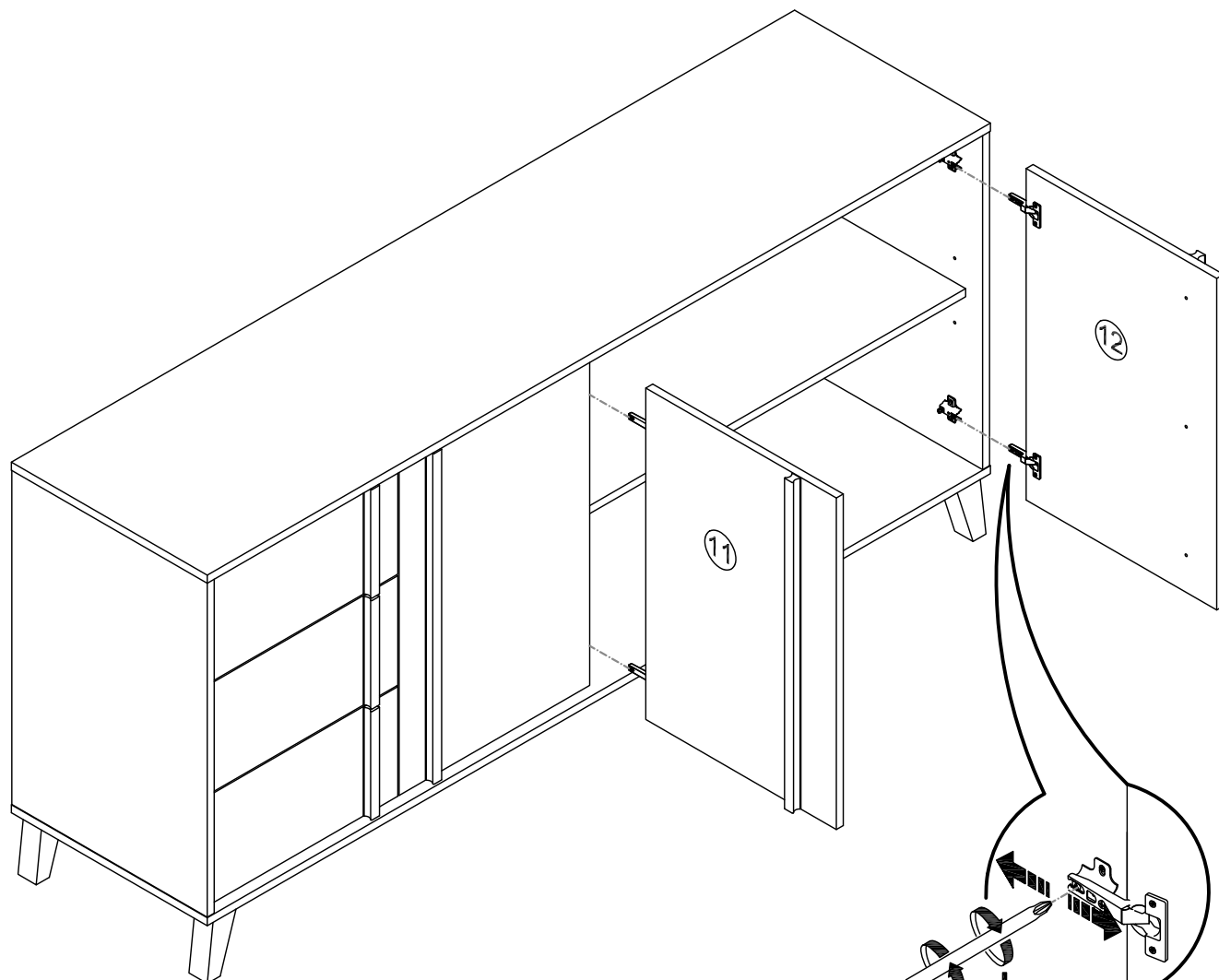
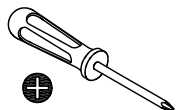

## FRANCAIS - SUISSE

### CONSEILS DE MONTAGE :

- 1 > BIEN ETUDIER LA NOTICE DE MONTAGE.
- 2 > REPEREZ LES PIECES CONSTITUANT VOTRE MEUBLE.
- 3 > REGROUPEZ ET CONTROLEZ LA QUINCAILLERIE.
- 4 > MUNISSEZ-VOUS DE L'OUTILLAGE NECESSAIRE.
- 5 > AMENAGEZ-VOUS UNE ZONE DE MONTAGE.
- 6 > PROCEDEZ AU MONTAGE.



**NE JAMAIS FORCER LES ASSEMBLAGES.**  
RESSERREZ LES VIS APRES QUELQUES TEMPS D'USAGE.  
GARDER VOTRE NOTICE DE MONTAGE, SI UNE PIECE  
VENAIT A MANQUER, ELLE SERAIT LE PLUS CLAIR  
MOYEN DE COMMUNIQUER AVEC VOTRE MAGASIN.

### CONSEILS D'ENTRETIEN :

- 1 > DÉPOUSSIÉREZ SOIGNEUSEMENT.
- 2 > UTILISEZ UN CHIFFON SEC.



**- NE JAMAIS UTILISER  
DE PRODUITS ABRASIFS:  
POUDRE, LAINE D'ACIER, SOLVANTS.  
- NE PAS MOUILLER**

	PAPIER DECOR	SURFACES STRATIFIEES	SURFACES LAQUEES	BOIS VERNIS	TEXTILE CUIR
EAU SAVONNEUSE (SAVON NEUTRE)	○	○	○	○	○
EAU ADDITIONNEE		○	○		
ENTRETIEN SPECIFIQUE FABRICANT					○

## DEUTSCH - SCHWEIZ

### MONTAGE ANLEITUNG:

- 1 > DIE MONTAGEANLEITUNG SORGFÄLTIG DURCHLESEN.
- 2 > DIE EINZELTEILE DES MÖBELSTÜCKS ERMITTELN.
- 3 > DIE BESCHLÄGE ZUSAMMENLEGEN UND PRÜFEN.
- 4 > DAS NOTWENDIGE WERKZEUG ZURECHTLEGEN.
- 5 > EINEN MONTAGEBEREICH FREIMACHEN.
- 6 > DAS MÖBELSTÜCK ZUSAMMENBAUEN.



**NIEMALS DIE VERBINDUNGEN ZU STARK ANZIEHEN.**  
DIE SCHRAUBEN NACH EINIGER ZEIT DES GEBRAUCHS  
ERNEUT FESTZIEHEN. DIE MONTAGEANLEITUNG  
GUT AUFBEWAHREN: SOLLTE EIN TEIL FEHLEN, IST SIE DAS  
BESTE VERSTÄNDIGUNGSMITTEL MIT IHREM GESCHÄFT.

### PFLEGEHINWEISE :

- 1 > SORGFÄLTIG ENTSTAUBEN.
- 2 > VERWENDEN SIE EIN TROCKENES TUCH.



**- BENUTZEN SIE KEINE  
SCHEUERMITTEL WIE PULVER,  
STAHLWOLLE, LÖSUNGSMITTEL.  
- KEIN WASSER VERWENDEN.**

	DEKORPAPIER	OBERFLÄCHE LAMINAT	OBERFLÄCHE LACK	LACKIERTEM HOLZ	TEXTIL LEDER
SEIFENLAUGE (NEUTRAL SEIFE)	○	○	○	○	○
WASSER MIT HAUSHALTSREINIGER		○	○		
PRODUZENT SPECIFISCHER UNTERHALT					○

## ITALIANO - SVIZZERA

### CONSIGLI DI MONTAGGIO

- 1 > STUDIARE BENE LE ISTRUZIONI DI MONTAGGIO.
- 2 > PRENDERE CONOSCENZA DEI PEZZI CHE COSTITUISCONO IL MOBILE.
- 3 > RAGGRUPPARE E CONTROLLARE LA FERRAMENTA.
- 4 > MUNIRSI DEGLI UTENSILI NECESSARI.
- 5 > PREPARARE UNA ZONA DI MONTAGGIO.
- 6 > PROCEDERE AL MONTAGGIO.



**NON FORZARE MAI GLI ASSEMBLAGGI**  
RISTRINGERE LE VITI DOPO UN PERIODO D'USO  
CONSERVARE QUESTE ISTRUZIONI DI MONTAGGIO,  
SE UN PEZZO VENISSE A MANCARE SAREBBE IL MIGLIORE  
MEZZO DI COMUNICAZIONE CON IL RIVENDITORE

### CONSIGLI PER LA MANUTENZIONE :

- 1 > SPOLVERATE ACCURATAMENTE.
- 2 > USARE UN PANNINO ASCIUTTO.



**- NON UTILIZZARE MAI PRODOTTI  
ABRASIVI: POLVERE,  
LANA DI ACCIAIO, SOLVENTI.  
- NON BAGNARE.**

	CARTA	SUPERFICIE STRATIFICATE	SUPERFICIE LACCATE	LACCATE EGNO VERNIGIATO	TESSILE CUOIO
ACQUA CON SAPONE (SAPONE NEUTRO)	○	○	○	○	○
ACQUA CON DETERSIVO SAN MARC		○	○		
MANUTENZIONE SPECIFICA PRODUTTORE					○

## PORTUGUÊS

### CONSELHOS DE MONTAGEM:

- 1 > ESTUDE BEM AS INSTRUÇÕES DE MONTAGEM.
- 2 > REUNA AS PEÇAS QUE CONSTITUEM O SEU MÓVEL.
- 3 > REAGRUPE AS FERRAGENS.
- 4 > EQUIPE-SE COM AS FERRAMENTAS NECESSÁRIAS.
- 5 > PREPARE UMA ÁREA PARA A MONTAGEM.
- 6 > INICIE A MONTAGEM.



NUNCA FORÇAR OS ENCAIXES.  
REAPERTAR OS PARAFUSOS APÓS UM TEMPO DE UTILIZAÇÃO.  
GUARDAR AS INSTRUÇÕES DE MONTAGEM.  
CASO FALTE ALGUMA PEÇA, O MAIS ACONSELHÁVEL  
É CONTATAR O REVENDEDOR.

### CONSELHOS PARA A MANUTENÇÃO:

- 1 > ELIMINAR BEM O PÓ.
- 2 > USAR PAÑO SECO.



- NUNCA UTILIZAR PRODUTOS  
ABRASIVOS: SAPONÁCEOS,  
LÃ DE AÇO, SOLVENTES.  
- NÃO MOLHAR.

	ACABAMENTO IMITAÇÃO	SUPERFÍCIES ESTRATIFICADAS	SUPERFÍCIES LACADAS	MADEIRA ENVERNIZADA	TEXTEIS PELES
ÁGUA COM SABÃO (SABÃO NEUTRO)	<input type="radio"/>	<input type="radio"/>	<input type="radio"/>	<input type="radio"/>	<input type="radio"/>
ÁGUA COM DETERGENTE		<input type="radio"/>	<input type="radio"/>		
INSTRUÇÕES ESPECÍFICAS DO FABRICANTE					<input type="radio"/>

## ESPAÑOL

### CONSEJOS PARA EL MONTAJE:

- 1 > ESTUDIE ATENTAMENTE EL MANUAL DE MONTAJE.
- 2 > LOCALICE LAS PIEZAS QUE CONSTITUYEN SU MUEBLE.
- 3 > REUNA Y CONTROLE LOS TORNILLOS.
- 4 > EQUIPE-SE DE LAS HERRAMIENTAS NECESARIAS.
- 5 > PREPARE UNA ZONA DE MONTAJE.
- 6 > REALICE EL MONTAJE.



NO FUERCE NUNCA EN LAS UNIONES. APRIETE LOS  
TORNILLOS DESPUES DE CIERTO TIEMPO DE UTILIZACION  
CONSERVE SU MANUAL DE MONTAJE,  
SI FALTARA UNA PIEZA, SERIA LA MANERA  
MAS FACIL DE COMUNICAR CON LA TIENDA.

### CONSEJOS PARA EL MANTENIMIENTO:

- 1 > DESPOLVEAREAR CULDADOSAMENTE.
- 2 > UTILICE UN PAÑO SECO.



- NO USE NUNCA PRODUCTOS  
ABRASIVOS TALES COMO:  
POLVO DE LIMPIAR,  
LANA DE ACERO, SOLVENTES.  
- NO MOJAR.

	PAPEL DE DECORACION	SUPERFICIE ESTRATIFICADAS	SUPERFICIE MAQUEADAS	MADERA BARNIZADA	TEXTIL CUERO
AGUA Y JABON (JABON NEUTRO)	<input type="radio"/>	<input type="radio"/>	<input type="radio"/>	<input type="radio"/>	<input type="radio"/>
AGUA COM DETERGENTE		<input type="radio"/>	<input type="radio"/>		
MANTENIMIENTO ESPECIFICO DEL FABRICANTE					<input type="radio"/>

## HRVATSKA

### UPUTE ZA MONTAŽU:

- 1 > PAŽLJIVO PROČITAJTE UPUTE ZA MONTAŽU.
- 2 > PRIPREMITE SVE DIJELOVE NAMJEŠTAJA.
- 3 > PRIKUPITE I PROVJERITE OKOVE ZA MONTAŽU.
- 4 > PRIPREMITE POTREBAN ALAT.
- 5 > PRIPREMITE PROSTOR ZA MONTAŽU.
- 6 > POČNITE MONTIRATI.



NEMOJTE UPOTREBLJAVATI SILU PRILIKOM SKLAPANJA  
NAKON NEKOG VREMENA PONOVRNO PRITEGNITE VIJKE  
ČUVAJTE UPUTE ZA MONTAŽU  
U SLUČAJU NEDOSTATKA NEKOG DIJELA NAJBOLJE ĆE BITI DA  
DA KONTAKIRATE PRODAJNO MJESTO.

### UPUTE ZA ODRŽAVANJE :

- 1 > PAŽLJIVO OBRISATI PRAŠINU.
- 2 > KORISTITE SUHU KRPU.



- ZABRANJENA JE UPOTREBA  
KEMIKALIJA ILI BILO KAKVIH  
POMOĆNIH SREDSTAVA ZA RIBANJE  
JAKIH SREDSTAV ZA ČIŠĆENJE ILI  
ČELIČNE VUNE  
-NE MOKRA.

	PAPIR	LAMINAT	LAK	DRVO	TEKSTIL/ KOŽA
OTPINA SAPUNA	<input type="radio"/>	<input type="radio"/>	<input type="radio"/>	<input type="radio"/>	<input type="radio"/>
OTPINA DETERDŽENTA		<input type="radio"/>	<input type="radio"/>		
NAMJENSKA SREDSTVA					<input type="radio"/>

## TÜRKÇE

### MONTAJ TALİMATLARI:

- 1 > Montaj tanıtım yazısını dikkatlice okuyunuz.
- 2 > Mobilyanızı oluşturan parçaları işaretleyiniz.
- 3 > Hırdavatla ilgili parçaları bir araya toplayıp; kontrol ediniz.
- 4 > Gereken araç ve gereci tedarik ediniz.
- 5 > (Kendinize) Bir montaj alanı ediniz.
- 6 > Monte etmeye başlayınız.



**MONTAJLARI ZORLAMAYINIZ.**  
BİRKAÇ KULLANIMDAN SONRA VİDALARI SIKIŞTIRINIZ.  
BİR PARÇANIN KAYBOLMASI DURUMUNDA MAĞAZANIZLADAKİ  
KOLAY İLETİŞİME GEÇEBİLMENİZ İÇİN MONTAJ KULLANIM  
TALİMATINIZI SAKLAYINIZ.

### BAKIM TALİMATLARI:

- 1 > TOZUNU DİKKATLİCE ALINIZ.
- 2 > YUMUŞAK BİR BEZİ TEMİZ SU VE AZ MİKTARDA SABUNLA(DETERJAN) NEMLENDİRİNİZ.



- ASLA AŞINDIRICI ÜRÜNLER  
KULLANMAYINIZ : ÇELİK YÜNÜ,  
SOLVENT...  
- BOL SUYLA YIKAMAYINIZ.

	SÜS KAĞIDI	KATMAN YÜZEY	LAKE YÜZEY	ÇİLALI TAHTA	TEKSTİL DERİ
SABUNLU SU (NÖTR SABUN)	○	○	○	○	○
DETERJAN KATILMIŞ SU		○	○		
ÜRETİCİYE ÖZGÜ BAKIM					○

## ENGLISH

### ASSEMBLY ADVICE :

- 1 > CAREFULLY READ THE ASSEMBLY INSTRUCTION.
- 2 > IDENTIFY THE COMPONENTS OF THE FURNITURE.
- 3 > GROUP AND CHECK THE HARDWARE.
- 4 > USE THE REQUIRED TOOLS.
- 5 > CREATE AN ASSEMBLY ZONE.
- 6 > MAKE THE ASSEMBLY.



**NEVER FORCE THE CONNECTIONS.**  
RE-TIGHTEN THE SCREWS AFTER FEW DAYS.  
PLEASE RETAIN THE AI LEAFLET FOR FUTURE REFERENCE,  
THE AI CONTAINS INFORMATION WHEN CLAIMING  
FOR MISSING PARTS.

### CLEANING ADVICE:

- 1 > CAREFULLY REMOVE THE DUST.
- 2 > USE A SOFT, CLEAN DAMP CLOTH WITH SOAPY WATER.



**NEVER USE ABRASIVE PRODUCTS  
OR SOLVENTS.**  
DO NOT APPLY EXCESSIVE PRESSURE  
WHEN USING THE DAMP CLOTH.

	PAPER DECOR	LAMINATED SURFACES	LACQUERED SURFACE	VARNISHED WOOD	LEATHER TEXTILE
SOAPY WATER (NEUTRAL SOAP)	○	○	○	○	○
WATER WITH DETERGENT		○	○		
SPECIFIC SUPPLIER CLEANING					○

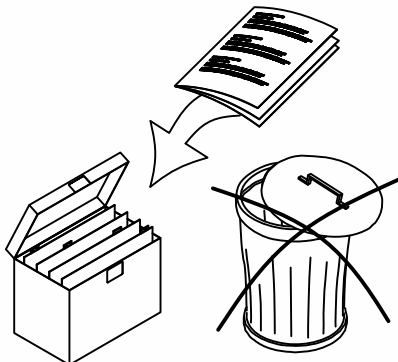

# talesa

Avd. de la Llibertat, 34  
Apdo. de correos 108  
46600 ALZIRA (Valencia)  
sav@talesa.es  
S.A.V. +34 96 184 98 24