

EAN CODE: 8435178310149

12083

**CABEZAL 1.50/1.60 ROMANTICA
TETE DE LIT 1.50/1.60 ROMANTICA**

**NOTICE DE MONTAGE
ASSEMBLY INSTRUCTIONS
MONTAGEANLEITUNG
ISTRUZIONI DI MONTAGGIO
INSTRUÇÕES DE MONTAGEM
INSTRUCCIONES DE MONTAJE
UPUTE ZA MONTAZU
MONTAJ TALIMATI**

ME
marckeric

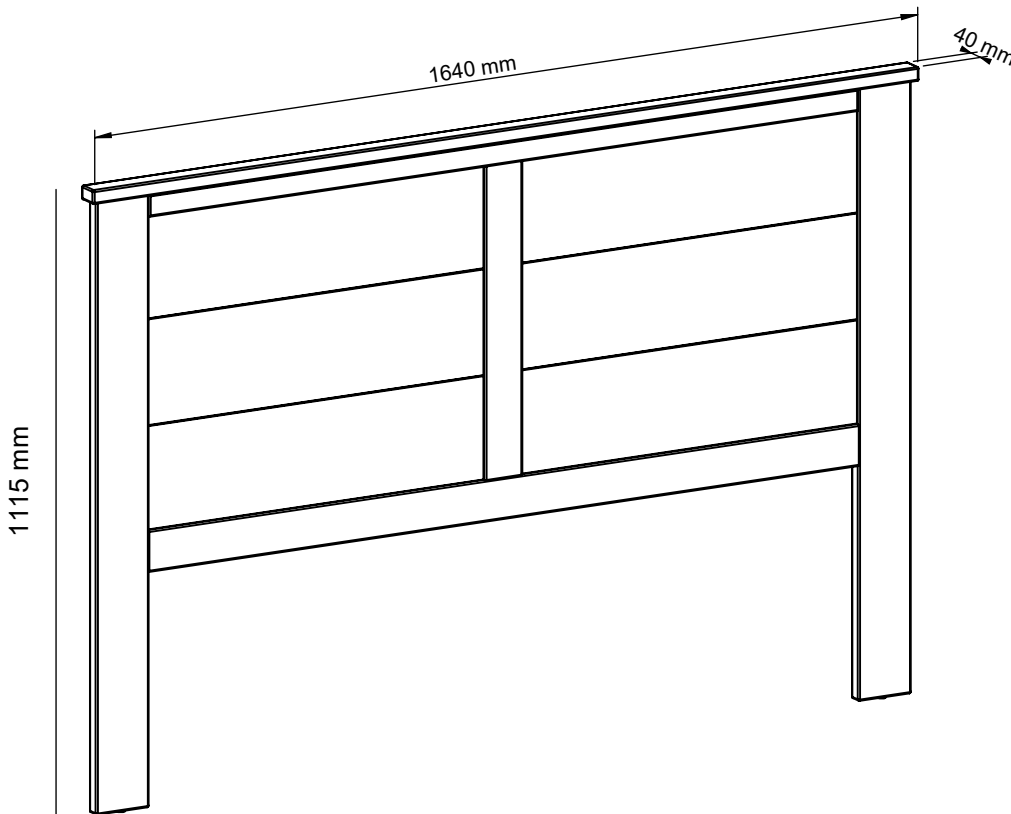

*AVANT DE COMMENCER, SE
REPORTER AUX CONSEILS
DE MONTAGE EN ANNEXE*

*BEFORE STARTING, REFER
TO THE ASSEMBLING ADVICE
IN ANNEX*

*VOR DIE MONTAGE,
BEILIEGENDE ANWEISUGEN
BEFOLGEN*

*PRIMA DI COMINCIARE
LEGGETE LE ISTRUZIONI DI
MONTAGGIO*

*ANTES DE COMEÇAR, ADIAR
SE AOS CONSELHOS DE
MONTAGEM EM ANEXO*

*ANTES DE EMPEZAR
CONSULTE LOS CONSEJOS
PARA EL MONTAJE*



*PRJE POÇETKA MONTAŽE
MOLIMO PAŽILJIVO
PROČITAJTE UPUTE ZA
MONTAZU*

*BASLAMADAN ÖNCE
EKTEKI MONTAJ TALIMATLARINI
İNCELEYİMİZ*

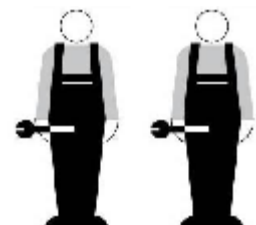
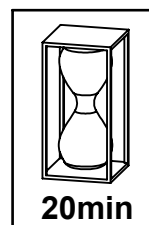
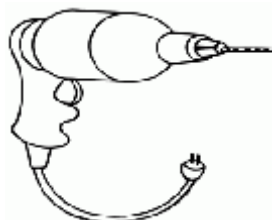
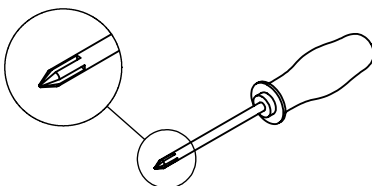
Cx	Tamaño de la caja Dimensions colis	Peso bruto Poids brut	Peso neto Poids net
1/1	1685x1155x45mm	16.5Kg	16Kg



HERRAJES - QUINCALLERIE - HARDWARE

Ax2	 Ø4x20	Bx1		Cx2	
-----	--	-----	---	-----	---

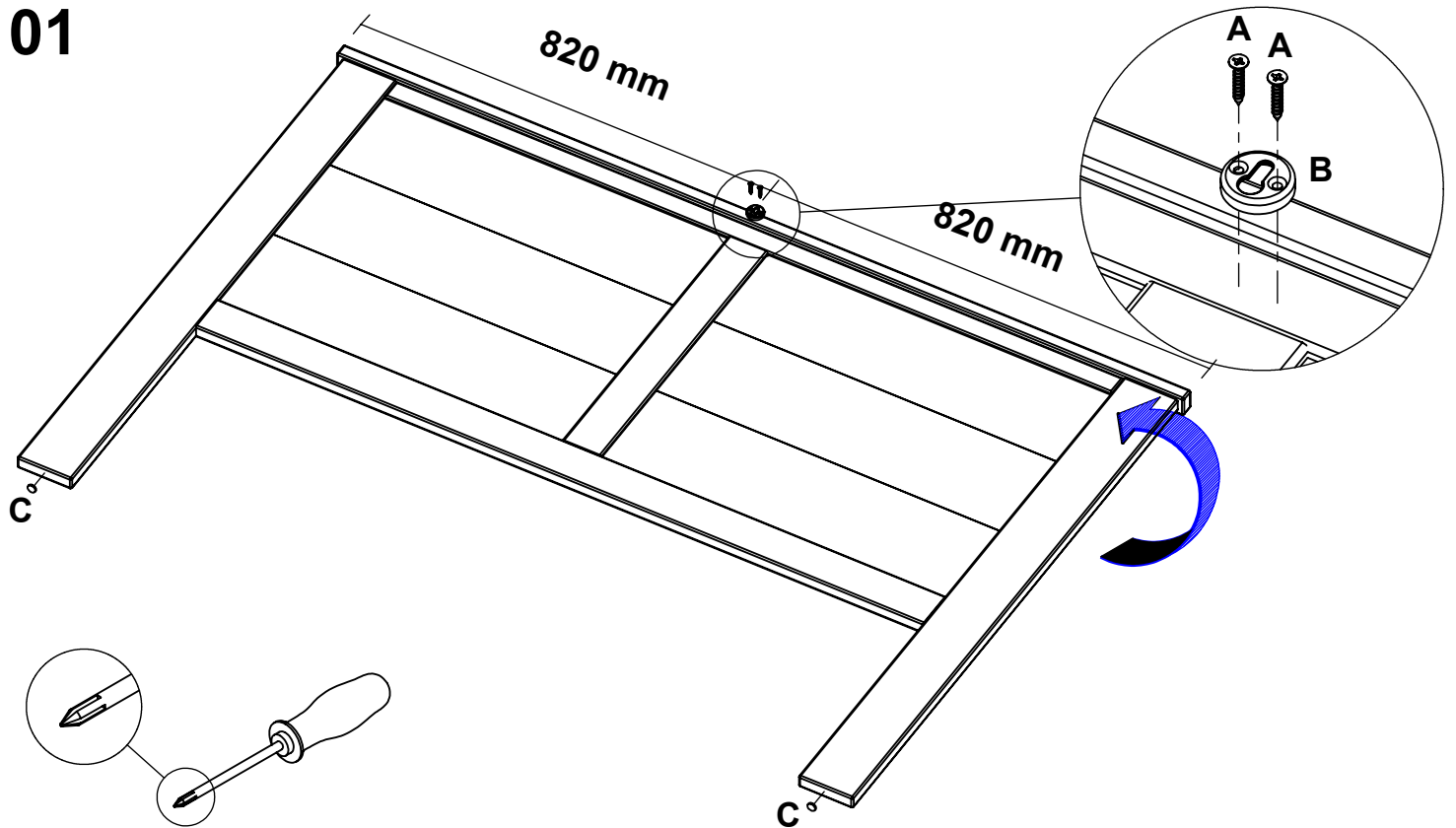

Ax2	 Ø4x20	Bx1		Cx2	
-----	---	-----	---	-----	---

! FIXATION MURALE OBLIGATORIE !
UTILISEZ DES VIS ET DES CHEVILLES ADAPTÉES A VOS MURS !

Il existe une grande diversité de types de murs ou cloisons, c'est la raison pour laquelle nous ne pouvons vous fournir une quincaillerie adaptée à votre mur. Il est nécessaire d'identifier le type de paroi à laquelle vous allez fixer ce produit afin de vous procurer les fixations appropriées. En cas de besoin, adressez vous à un magasin spécialisé pour conseil

! OBLIGATORIO FIJAR A LA PARED !
UTILICE LOS TORNILLOS Y TACOS ADECUADOS PARA SU MURO !

Existe una gran diversidad de muros y paredes, por esta razón no podemos proporcionarle el herraje adecuado para su pared. Primero, es necesario identificar el tipo de pared para luego utilizar el herraje adecuado. En caso de duda, dirijase a una tienda especializada para más información.

! OBLIGATORY FIX ON THE WALL !
USE SCREWS AND PLUGS SUITABLES FOR YOUR WALL !

Due to the wide diversity of wall or partition types, we cannot provide you with suitable attachment fixtures. To determine which attachment fixtures to use, you will need to identify the type of wall to which you will be fixing this product. If you have whatever doubt, please, go to one specialised shop for further information.



French

IMPORTANT: Pour éviter le basculement accidentel du meuble, la fixation du meuble au mur est obligatoire.

La visserie nécessaire pour la jonction mur/meuble, dépendante de la nature du mur, n'est pas fournie. En cas de doute, consulter un spécialiste

English

IMPORTANT: To avoid the accidental tip-over of the furniture, the fixing of the furniture on the wall is mandatory.

The needed hardware for the junction wall/furniture, depending of the nature of the wall, is not provided. If any doubt, consult a specialist.

Spanish

IMPORTANTE: Para evitar el vuelco accidental de los muebles, es obligatorio fijarlos en la pared.

El tipo de tornillos necesarios para fijar el mueble a la pared, dependen del material de la pared, no se suministran. En caso de duda, consulte a un especialista

Portuguese

IMPORTANTE: Para evitar a queda accidental de móveis, é obrigatório fixá-los na parede. O tipo de parafusos para a fixação de mobiliário na parede, depende do material de parede e não são fornecidos. Em caso de dúvida, consulte um especialista.

Italian

IMPORTANTE: Per evitare il ribaltamento accidentale del mobile è obbligatorio il fissaggio a muro.

I tasselli necessari per il collegamento mobile\muro, dipendenti dal tipo di muro, non sono provvisti.

Consultare uno specialista in caso di dubbi

Croatian

VAŽNO: Kako bi se izbjeglo slučajno prevrtanje, namještaj je potrebno pričvrstiti na (uza) zid.

Različite vrste zidova zahtijevaju upotrebu različitih vrsta vijaka i tipli. Uvijek koristiti one koji su prikladni za vrstu zidova u domu. Vijci i tiple prodaju se zasebno.

U slučaju bilo kakvih sumnji, obratite se stručnjaku.

German

WICHTIG : Um ein versehentliches Kippen des Möbels zu vermeiden, ist die Befestigung an der Wand zwingend vorgeschrieben.

Die benötigten Schrauben zur Wandbefestigung, welche von der Beschaffenheit der Mauer abhängen, sind nicht in der Lieferung enthalten. Wenden Sie sich bitte bei Zweifel an einen Spezialisten.



Il existe une grande diversité de types de murs ou cloisons, c'est la raison pour laquelle nous ne pouvons vous fournir le type exact de fixation. Il est nécessaire d'identifier le type de paroi à laquelle vous allez fixer ce produit afin de vous procurer les fixations appropriées. Voici quelques exemples de fixations conseillées pour:



LES MURS PLEIS

Cheville nylon "FISCHER"

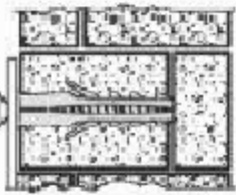
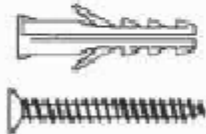

Cheville d'ancrage métal

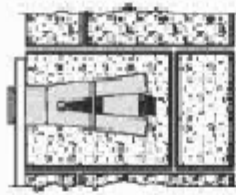
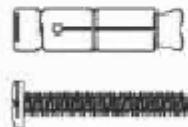

Cheville d'ancrage Ailettes en nylon

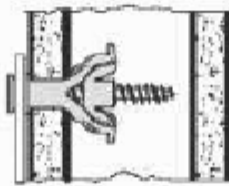
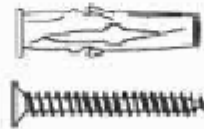

LES CLOISONS CREUSES

Cheville métallique A expansion

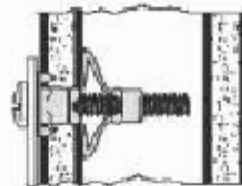
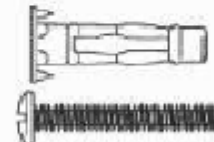

Cheville "MOLLY"

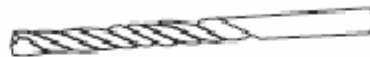
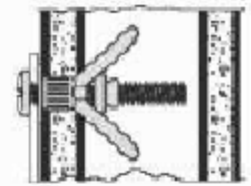
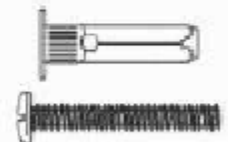

Utiliser une taile de forêt adaptée à la quincaillerie utilisée et au type de mur.



Due to the wide diversity of wall or partition types, we cannot provide you with suitable attachment fixtures. To determine which attachment fixtures to use, you will need to identify the type of wall to which you will be fixing this product. Here are some examples of attachment fixtures recommended for:



BLIND WALLS

"FISCHER"
Nylon plug

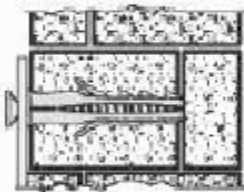
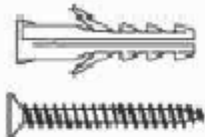

Metal
Wall plug

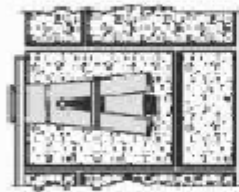

Nylon winged
Wall plug

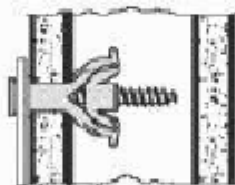
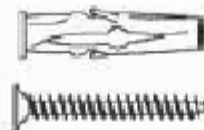

STUDDED WALLS

Metal expansion
plug

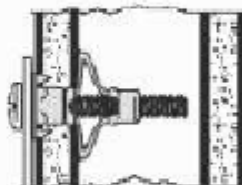

"MOLLY" plug

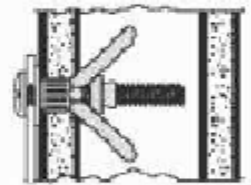
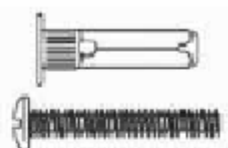

Use a drill bit that is compatible in size with the hardware used and the type of wall.



Esiste una gran varietà di tipi di muri o paratie e noi siamo in grado di fornirvi il tipo esatto di fissaggio per ognuno di essi. E' necessario identificare il tipo di parete alla quale intendete fissare questo prodotto in modo da fornirvi i fissaggi più idonei. Ecco qualche esempio di fissaggi consigliati per:



IMURI PIENI

PARATIE CAVE

**TASSELLO NYLON
"FISCHER"**

**TASSELLO DI
ANCORAGGIO IN
METALLO**

**TASSELLO DI
ANCORAGGIO AD
ALETTE IN NYLON**

**TASSELLO METALLICO
AD ESPANSIONE**

**TASSELLO
"MOLLY"**

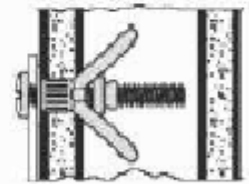
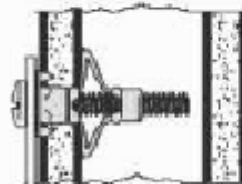
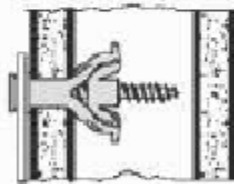
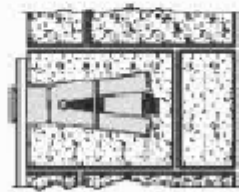
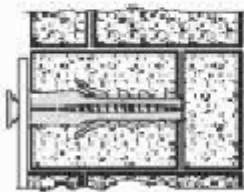
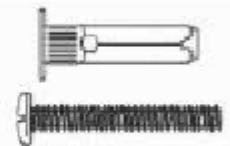
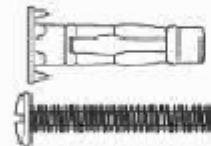
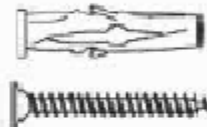
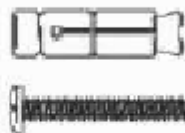
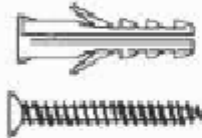

Utilizzare una punta di trapano adatta agli utensili utilizzati e al tipo di muro.



Es gibt eine Vielzahl verschiedener Arten von Mauern oder Zwischenwänden, und aus diesem Grunde können wir Ihnen den genau entsprechenden Befestigungstyp nicht bereitstellen. Zunächst ist es erforderlich, die exakte Bauart der Wand zu ermitteln, an der Sie dieses Produkt anbringen werden, um die für diese Wand geeigneten Befestigungsmittel im Fachhandel erwerben zu können. Nachfolgend einige Beispiele empfohlener Befestigungen für:



VOLLWÄNDE

HOHLWÄNDE

**NYLONDÜBEL
„FISCHER“**

**ANKERDÜBEL
AUS METALL**

**ANKERDÜBEL MIT
NYLONFLÜGELN**

**SPREZDÜBEL FÜR
VERANKERUNG AUS METALL**

MOLLY-DÜBEL

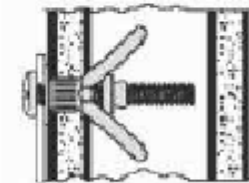
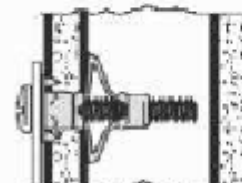
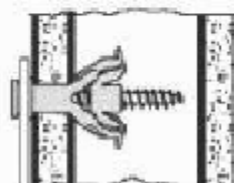
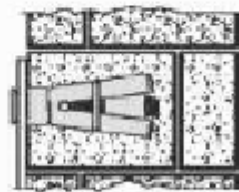
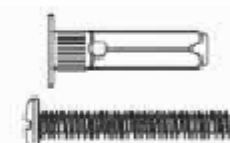
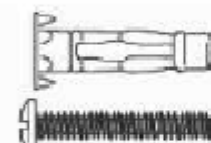
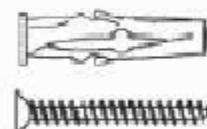
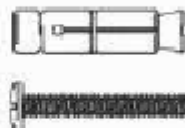
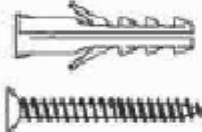

Bitte verwenden Sie eine für die Eisenwaren und den Wandtyp geeignete Bohrergröße.

02

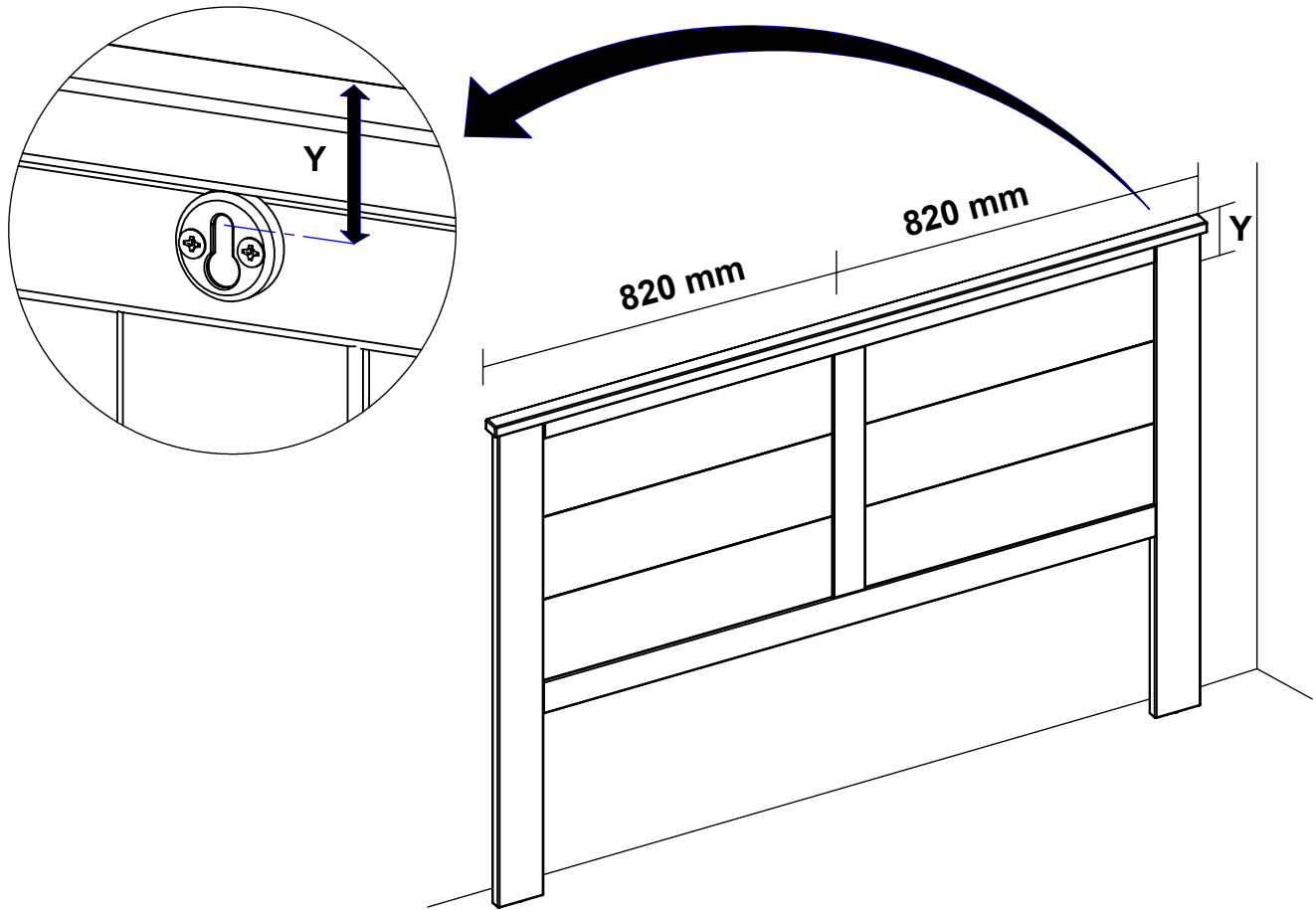

03

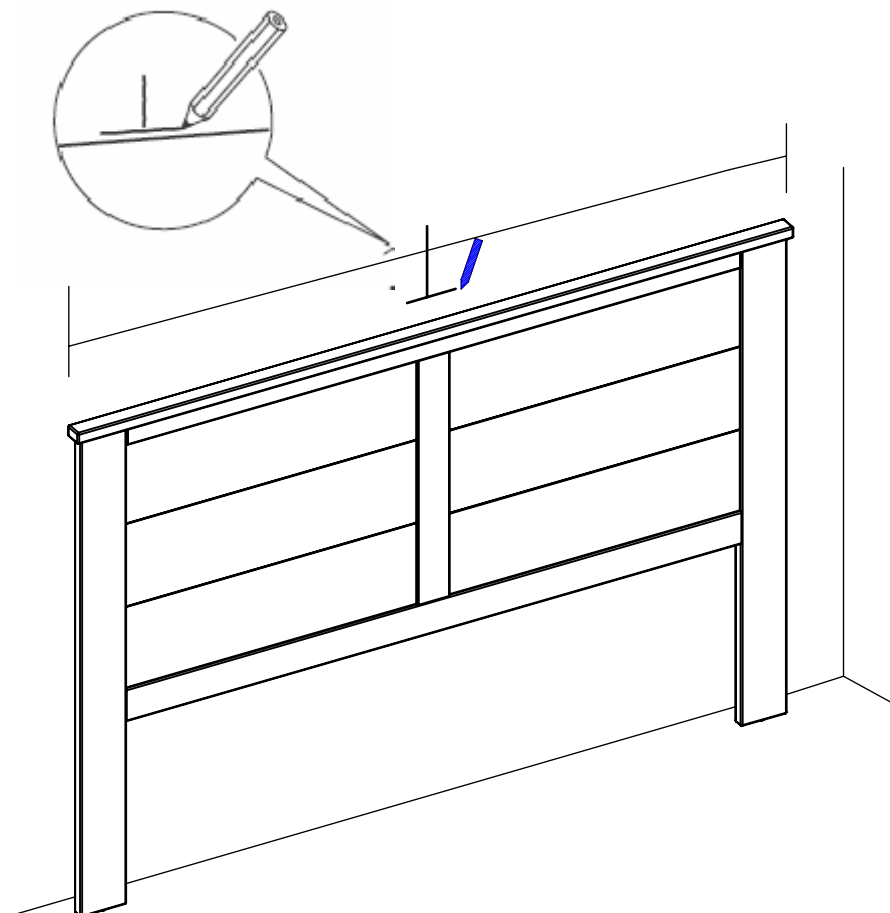

04

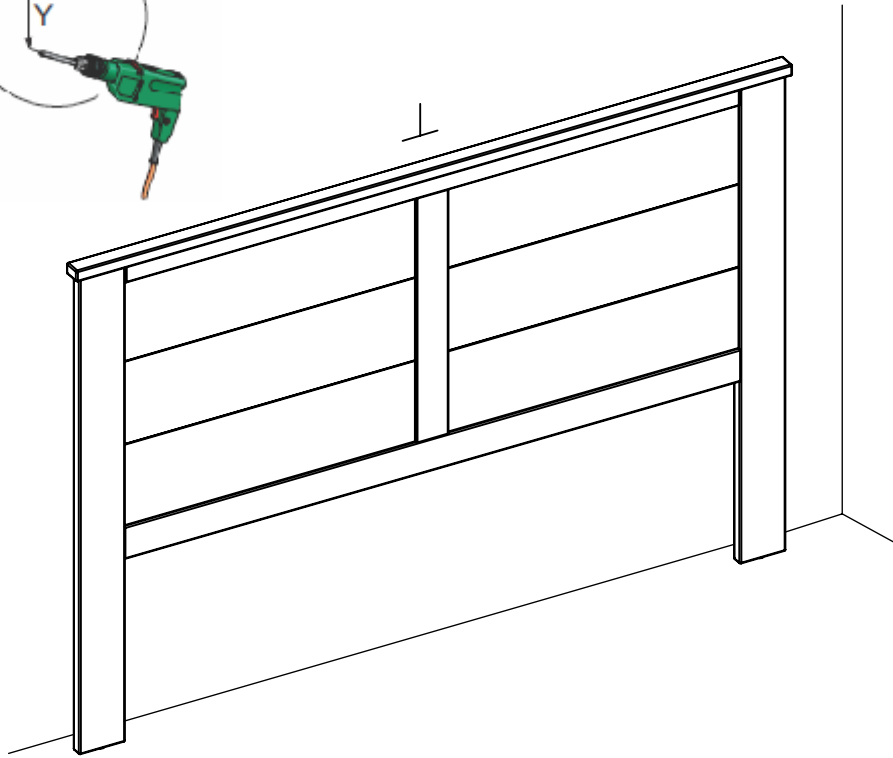

05

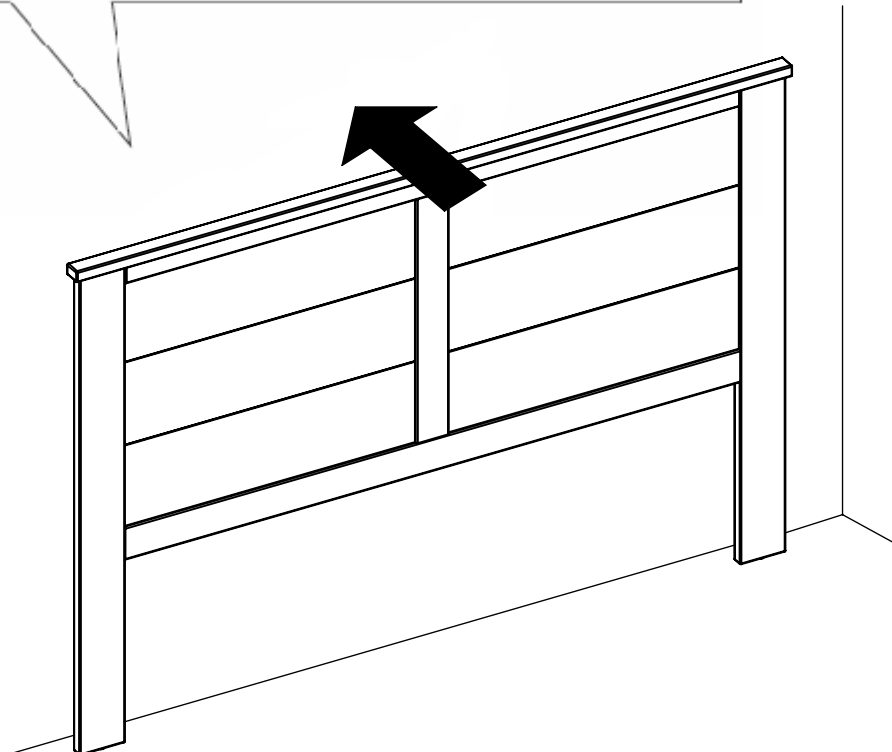
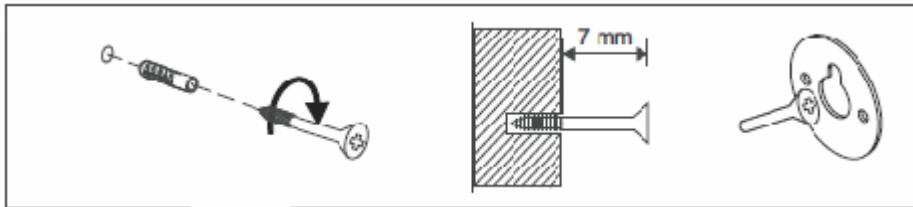

FRANCAIS - SUISSE

CONSEILS DE MONTAGE :

- 1 > BIEN ETUDIER LA NOTICE DE MONTAGE.
- 2 > REPEREZ LES PIÈCES CONSTITUANT VOTRE MEUBLE.
- 3 > REGROUPEZ ET CONTRÔLEZ LA QUINCAILLERIE.
- 4 > MUNISSEZ-VOUS DE L'OUTILLAGE NECESSAIRE.
- 5 > AMENAGEZ-VOUS UNE ZONE DE MONTAGE.
- 6 > PROCEDEZ AU MONTAGE.



**NE JAMAIS FORCER LES ASSEMBLAGES.
RESERREZ LES VIS APRES QUELQUES TEMPS D'USAGE.
GARDER VOTRE NOTICE DE MONTAGE, SI UNE PIÈCE
VENAIT A MANQUER, ELLE SERAIT LE PLUS CLAIR
MOYEN DE COMMUNIQUER AVEC VOTRE MAGASIN.**

CONSEILS D'ENTRETIEN :

- 1 > DÉPOUSSIEREZ SOIGNEUSEMENT.
- 2 > UTILISEZ UN CHIFFON SEC.



**- NE JAMAIS UTILISER
DE PRODUITS ABRASIFS:
POUDRE, LAINE D'ACIER, SOLVANTS.
- NE PAS MOILLER**

	PAPIER DÉCOR	SURFACES STRATIFIÉES	SURFACES LAQUÉES	BOIS VERNIS	TEXTILE CUIR
EAU SAVONNEUSE (SAVON NEUTRE)	○	○	○	○	○
EAU ADDITIONNÉE		○	○		
ENTRETIEN SPÉCIFIQUE FABRICANT					○

DEUTSCH - SCHWEIZ

MONTAGE ANLEITUNG:

- 1 > DIE MONTAGEANLEITUNG SORGFÄLTIG DURCHLESEN.
- 2 > DIE EINZELTEILE DES MÖBELSTÜCKS ERMITTELN.
- 3 > DIE BESCHLÄGE ZUSAMMENLEGEN UND PRÜFEN.
- 4 > DAS NOTWENDIGE WERKZEUG ZURECHTLEGEN.
- 5 > EINEN MONTAGEBEREICH FREIMACHEN.
- 6 > DAS MÖBELSTÜCK ZUSAMMENBAUEN.



**NIEMALS DIE VERBINDUNGEN ZU STARK ANZIEHEN.
DIE SCHRAUBEN NACH EINIGER ZEIT DES GEBRAUCHS
ERNEUT FESTZIEHEN. DIE MONTAGEANLEITUNG
GUT AUFBEWAHREN: SOLLTE EIN TEIL FEHLEN, IST SIE DAS
BESTE VERSTÄNDIGUNGSMITTEL MIT IHREM GESCHÄFT.**

PFLEGEHINWEISE :

- 1 > SORGFÄLTIG ENTSTAUBEN.
- 2 > VERWENDEN SIE EIN TROCKENES TUCH.



**- BENUTZEN SIE KEINE
SCHEUERMITTEL WIE PULVER,
STAHLWOLLE, LÖSUNGSMITTEL.
- KEIN WASSER VERWENDEN.**

	DÉKORPAPIER	OBERFLÄCHE LAMINIÉ	OBERFLÄCHE LACK	LACKIERTEM HOLZ	TEXTIL LEDER
SEIFENLAUGE (NEUTRALSEIFE)	○	○	○	○	○
WASSER MIT HAUSHALTSREINIGER		○	○		
PRODUZENT SPEZIFISCHER UNTERHALT					○

ITALIANO - SVIZZERA

CONSIGLI DI MONTAGGIO

- 1 > STUDIARE BENE LE ISTRUZIONI DI MONTAGGIO.
- 2 > PRENDERE CONOSCENZA DEI PEZZI CHE COSTITUISCONO IL MOBILE.
- 3 > RAGGRUPPARE E CONTROLLARE LA FERRAMENTA.
- 4 > MUNIRSI DEGLI UTENSILI NECESSARI.
- 5 > PREPARARE UNA ZONA DI MONTAGGIO.
- 6 > PROCEDERE AL MONTAGGIO.



**NON FORZARE MAI GLI ASSEMBLAGGI
RISTRINGERE LE VITI DOPO UN PERIODO D'USO
CONSERVARE QUESTE ISTRUZIONI DI MONTAGGIO,
SE UN PEZZO VENISSE A MANCARE SAREBBE IL MIGLIORE
MEZZO DI COMUNICAZIONE CON IL RIVENDITORE**

CONSIGLI PER LA MANUTENZIONE :

- 1 > SPOLVERATE ACCURATAMENTE.
- 2 > USARE UN PANNINO ASCIUTTO.



**- NON UTILIZZARE MAI PRODOTTI
ABRASIVI: POLVERE,
LANA DI ACCIAIO, SOLVENTI
- NON BAGNARE.**

	CARTA	SUPERFICIE STRATIFICATE	SUPERFICIE LACATE	LACCATO OMO VERNIGATO	TESSILE CUIRO
ACQUA CON SAPONE (SAPONE NEUTRO)	○	○	○	○	○
ACQUA CON DETERGENTE SANMARC		○	○		
MANUTENZIONE SPECIFICA PRODUTTORE					○

PORTUGUÊS

CONSELHOS DE MONTAGEM:

- 1 > ESTUDE BEM AS INSTRUÇÕES DE MONTAGEM.
- 2 > REUNA AS PEÇAS QUE CONSTITUEM O SEU MÓVEL.
- 3 > REAGRUPE AS FERRAGENS.
- 4 > EQUIPE-SE COM AS FERRAMENTAS NECESSÁRIAS.
- 5 > PREPARE UMA ÁREA PARA A MONTAGEM.
- 6 > INICIE A MONTAGEM.



NUNCA FORÇAR OS ENCAIXES.
REAPERTAR OS PARAFUSOS APÓS UM TEMPO DE UTILIZAÇÃO.
GUARDAR AS INSTRUÇÕES DE MONTAGEM.
CASO FALTE ALGUMA PEÇA, O MAIS ACONSELHÁVEL
É CONTATAR O REVENDEDOR.

CONSELHOS PARA A MANUTENÇÃO:

- 1 > ELIMINAR BEM O PÓ.
- 2 > USAR PAÑO SECO.



- NUNCA UTILIZAR PRODUTOS
ABRASIVOS: SAPONÁCEOS,
LÃ DE AÇO, SOLVENTES.
- NÃO MOLHAR.

	ACABAMENTO IMITAÇÃO	SUPERFÍCIES ESTRATIFICADAS	SUPERFÍCIES LACADAS	MADERA ENVERNIZADA	TEXTOS PELES
ÁGUA COM SABÃO (SABÃO NEUTRO)	<input type="radio"/>	<input type="radio"/>	<input type="radio"/>	<input type="radio"/>	<input type="radio"/>
ÁGUA COM DETERGENTE		<input type="radio"/>	<input type="radio"/>		
INSTRUÇÕES ESPECÍFICAS DO FABRICANTE					<input type="radio"/>

ESPAÑOL

CONSEJOS PARA EL MONTAJE:

- 1 > ESTUDIE ATENTAMENTE EL MANUAL DE MONTAJE.
- 2 > LOCALICE LAS PIEZAS QUE CONSTITUYEN SU MUEBLE.
- 3 > REUNA Y CONTROLE LOS TORNILLOS.
- 4 > EQUIPE-SE DE LAS HERRAMIENTAS NECESARIAS.
- 5 > PREPARE UNA ZONA DE MONTAJE.
- 6 > REALICE EL MONTAJE.



NO FUERCE NUNCA EN LAS UNIONES. APRIETE LOS
TORNILLOS DESPUES DE CIERTO TIEMPO DE UTILIZACION
CONSERVE SU MANUAL DE MONTAJE,
SI FALTARA UNA PIEZA, SERIA LA MANERA
MAS FACIL DE COMUNICAR CON LA TIENDA.

CONSEJOS PARA EL MANTENIMIENTO:

- 1 > DESPOLVOREAR CUIDADOSAMENTE.
- 2 > UTILICE UN PAÑO SECO.



- NO USE NUNCA PRODUCTOS
ABRASIVOS TALES COMO:
POLVO DE LIMPIAR,
LANA DE ACERO, SOLVENTES.
- NO MOJAR.

	PAPEL DE DECORACION	SUPERFICIE ESTRATIFICADAS	SUPERFICIE MADERADAS	MADERA BARNIZADA	TEXTIL CUERO
AGUA Y JABON (JABON NEUTRO)	<input type="radio"/>	<input type="radio"/>	<input type="radio"/>	<input type="radio"/>	<input type="radio"/>
AGUA CON DETERGENTE		<input type="radio"/>	<input type="radio"/>		
MANTENIMIENTO ESPECIFICO DEL FABRICANTE					<input type="radio"/>

HRVATSKA

UPUTE ZA MONTAŽU:

- 1 > PAŽLJIVO PROČITAJTE UPUTE ZA MONTAŽU.
- 2 > PRIPREMITE SVE DIOLOVE NAMJEŠTAJA.
- 3 > PRIKUPITE I PROVJERITE OKOVE ZA MONTAŽU.
- 4 > PRIPREMITE POTREBAN ALAT.
- 5 > PRIPREMITE PROSTOR ZA MONTAŽU.
- 6 > POČNITE MONTIRATI.



NEMOJTE UPOTREBLJAVATI SILU PRILIKOM SKLAPANJA
NAKON NEKOG VREMENA PONOVO PRITEGNITE VIJKE
ČUVAJTE UPUTE ZA MONTAŽU
U SLUČAJU NEDOSTATKA NEKOG DIJELA NAJBOLJE ĆE BITI DA
DA KONTAKIRATE PRODAJNO MJESTO.

UPUTE ZA ODRŽAVANJE:

- 1 > PAŽLJIVO OBRISATI PRAŠINU.
- 2 > KORISTITE SUHU KRPU.



- ZABRANJENA JE UPOTREBA
KEMIKALIJA ILI BILIKAKVIH
POMOĆNIH SREDSTAVA ZA IZBANJE
JAKIH SREDSTAVA ZA ČIŠĆENJE ILI
ČELIČNE VUNE
NE MOKRA.

	PAPIR	LAMINAT	LAK	DRVO	TEXTIL/ KOŽA
OTPIVA SA PUNA	<input type="radio"/>	<input type="radio"/>	<input type="radio"/>	<input type="radio"/>	<input type="radio"/>
OTPIVA DETERDŽENTA		<input type="radio"/>	<input type="radio"/>		
NAMJENSKA SREDSTVA					<input type="radio"/>

TÜRÇE

MONTAJ TALIMATLARI:

- 1 > MONTAJ TANITIM YAZISINI DİKKATLİĞE OKUYUNUZ .
- 2 > MOBİLYANIZI OLUŞTURAN PARÇALARI İŞARETLEYİNİZ.
- 3 > HIRDAVATLA İLGİLİ PARÇALARI BİR ARAYA TOPLAYIP; KONTROL EDİNİZ.
- 4 > GEREKEN ARAÇ VE GEREĞİ TEDARİK EDİNİZ.
- 5 > (KENDİNİZE) BİR MONTAJ ALANI EDİNİNİZ.
- 6 > MONTE ETMEYE BAŞLAYINIZ.



MONTAJLARI ZORLAMAYINIZ.
BİRKAÇ KULLANIMDAN SON RA VIDALARI SIKIŞTIRINIZ.
BİR PARÇANIN KAYBOLMASI DURUMUNDA MAGAZANIZLADA HA
KOLAY İLETİŞİME GEÇEBİLMENİZ İÇİN MONTAJ KULLANIM
TALIMATINIZI SAKLAYINIZ.

BAKIM TALIMATLARI:

- 1 > TOZUNU DİKKATLİĞE ALINIZ.
- 2 > YUMUŞAK BİR BEZİ TEMİZ SU VE AZ MİKTARDA SABUNLA (DETERJAN) NEMLENDİRİNİZ.



ASLA AŞINDIRICI ÜRÜNLER
KULLANMAYINIZ : ÇELİK YÜNÜ,
SOLVENT...
BOL SUYLA YIKAMAYINIZ.

	SÜSKAGIDI	KAYMAN YÜZEY	LAKE YÜZEY	GİHALI YANTA	TEKSTİL DERİ
SABUNLU SU (NÖTR SABUN)	<input type="radio"/>	<input type="radio"/>	<input type="radio"/>	<input type="radio"/>	<input type="radio"/>
DETERJAN KATILMIŞ SU		<input type="radio"/>	<input type="radio"/>		
ÖZGECİNE ÖZGÜ BAKIM					<input type="radio"/>

ENGLISH

ASSEMBLY ADVICE :

- 1 > CAREFULLY READ THE ASSEMBLY INSTRUCTION.
- 2 > IDENTIFY THE COMPONENTS OF THE FURNITURE.
- 3 > GROUP AND CHECK THE HARDWARE.
- 4 > USE THE REQUIRED TOOLS.
- 5 > CREATE AN ASSEMBLY ZONE.
- 6 > MAKE THE ASSEMBLY.



NEVER FORCE THE CONNECTIONS.
RE-TIGHTEN THE SCREWS AFTER FEW DAYS.
PLEASE RETAIN THE AI LEAFLET FOR FUTURE REFERENCE,
THE AI CONTAINS INFORMATION WHEN CLAIMING
FOR MISSING PARTS.

CLEANING ADVICE:

- 1 > CAREFULLY REMOVE THE DUST.
- 2 > USE A SOFT, CLEAN DAMP CLOTH WITH SOAPY WATER.



NEVER USE ABRASIVE PRODUCTS
OR SOLVENTS.
DO NOT APPLY EXCESSIVE PRESSURE
WHEN USING THE DAMP CLOTH.

	PAPER DECOR	LAMINATED SURFACES	LACQUERED SURFACE	VARNISHED WOOD	LEATHER TEXTILE
SOAPY WATER (NEUTRAL SOAP)	<input type="radio"/>	<input type="radio"/>	<input type="radio"/>	<input type="radio"/>	<input type="radio"/>
WATER WITH DETERGENT		<input type="radio"/>	<input type="radio"/>		
SPECIFIC SUPPLIER CLEANING					<input type="radio"/>



FRENCH: "Les meubles contenant des panneaux à base de bois (panneaux de particules, panneaux de fibres, contreplaqué...) peuvent émettre des substances polluantes dans l'air intérieur. Il est ainsi recommandé, après l'installation du meuble dans son logement, d'aérer fréquemment la pièce concernée pendant au moins quatre semaines afin de réduire son exposition aux polluants émis par le meuble."

SPANISH: Los muebles que contienen paneles a base de madera (Aglomerado, cartón, contrachapado ...) pueden emitir sustancias contaminantes en el aire. Por lo tanto, se recomienda airear frecuentemente los muebles al menos durante cuatro semanas después de su instalación para reducir su exposición a los contaminantes emitidos por los muebles.

ENGLISH: Furniture containing wood-based panels (Particle board, fibreboard, plywood ...) could emit pollutants on the air. Therefore, it is advisable to ventilate the furniture at least during four weeks after its assembly in order to reduce the exposure to the pollutants released by the furniture.